

PRODUCT CATALOGUE

EDITION 5

Components for Truck,
Bus, Off-highway and Rail

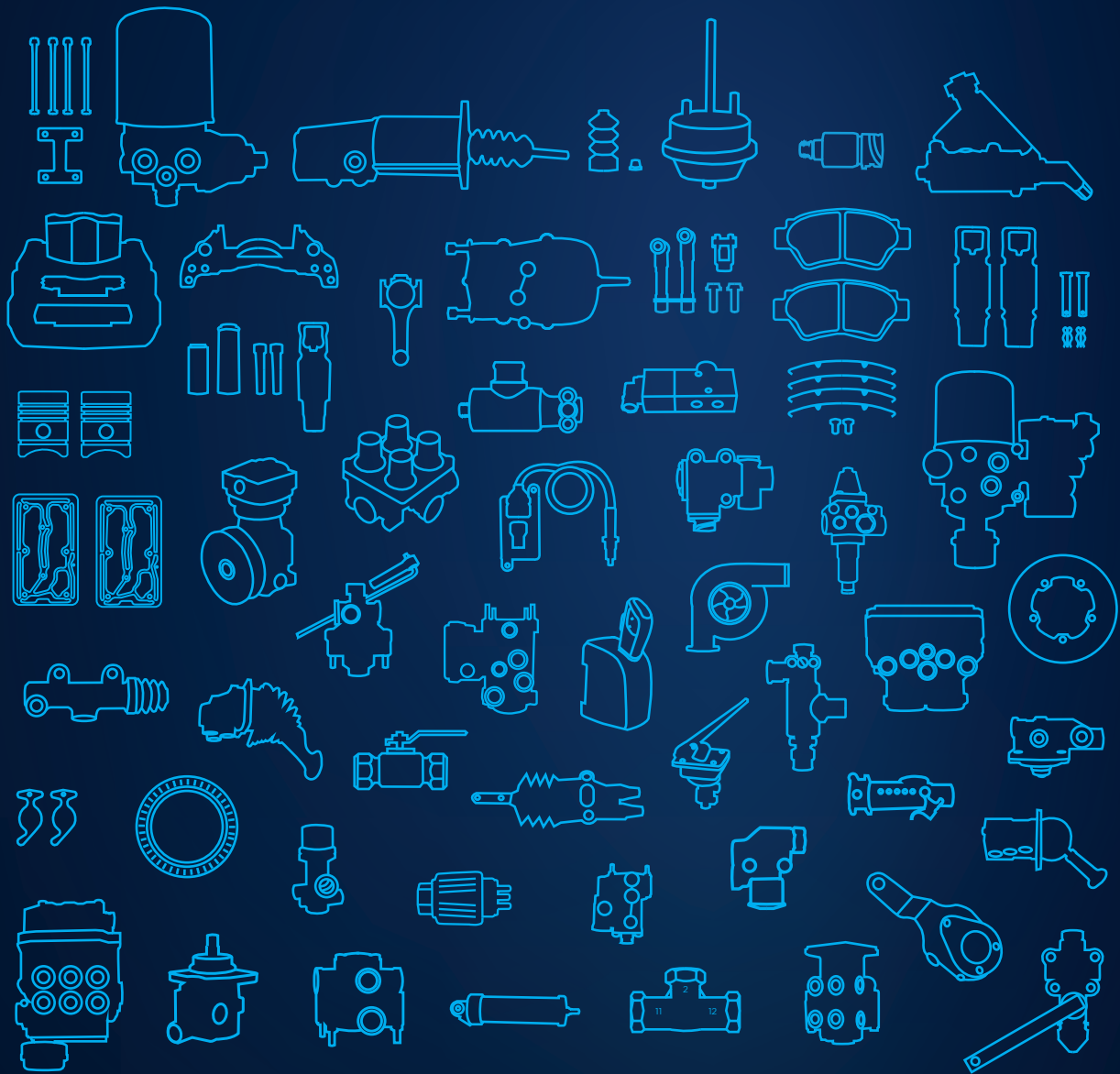

CONTACT US

Main Switchboard:		+44 (0)161 874 3100
Fax:		+44 (0)161 876 5890
Email:	(UK Sales)	sales@ebs.co.uk
	(Export Sales)	export@ebs.co.uk
	(Purchasing)	purchasing@ebs.co.uk
	(Accounts)	accounts@ebs.co.uk
	(Marketing)	marketing@ebs.co.uk
Website:	www.ebs.co.uk	

To assist our International customers, we can speak English, Falamos Português, Hablamos Español, Nous Parlons Français, Wij Spreken Nederlands, Si Parla Italiano, Wir Sprechen Deutsch, 我们讲中文, نتكلم العربية. ہم اردو بول سکتے ہیں



EBS is proud to be Europe's leading independent manufacturer and distributor of air brake and vehicle control system components, and repair kits, in both its own successful premium quality brand as well as various original brands.

Since its foundation, the workforce of the company has developed great experience in the field of air braking equipment, the quality of its products has led to an increasing demand for the EBS brand, with the result that EUROPEAN BRAKING SYSTEMS has become one of the largest European airbrake manufacturers, with its brand being instantly recognisable.

The renewal and the enlargement of the EBS range has been the major objectives since the beginning of activities. Consequently, the Research & Development department is in constant touch with the market place to allow expansion of new product ranges.



Copyright:

The content of this catalogue is copyrighted by European Braking Systems Limited, Units 1, 2, 3 & 4, Westpoint Enterprise Park, Clarence Avenue. Trafford Park, Manchester, M17 1QS, United Kingdom.

The EBS Logo, Catalogue design and packaging designs are registered trademarks of European Braking Systems Ltd.



OUR MISSION

To provide customers with a sustainable supply chain for quality aftermarket products through our extensive network of globally approved distributors.

QUALITY

An advanced ERP system supported by highly qualified engineers at all sites, together with tightly controlled production processes and lean manufacturing techniques sustain a warranty rate of below 0.25%.



DESIGN

Continual investment allows our Research & Development team to innovate, design and approve concepts of our rapidly expanding product portfolio.

MANUFACTURING

A state of the art manufacturing facility ensures paramount quality for the largest range of CV Brake calipers & associated braking components available to the aftermarket.

REMANUFACTURING

The longest established remanufacturing facility within the UK, supplying 5* quality parts that exceed OE standards.

ADVANTAGES

EBS holds massive product stocks at it's central warehouse.

EBS prides itself on having the biggest range of Brake system components globally, allowing EBS to offer a fast, reliable & off the shelf delivery.

PRODUCT CATALOGUES

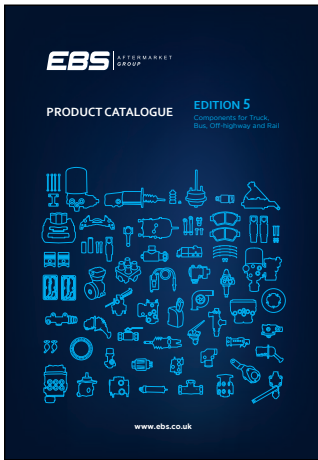

EBS Product Catalogue

REF: EBSCAT

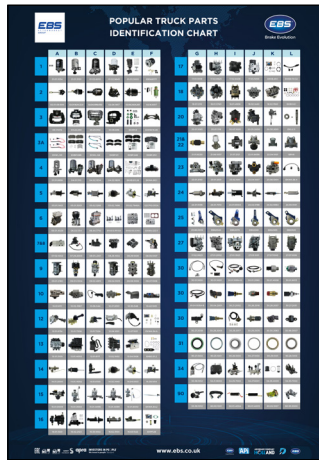

Popular truck parts Identification Chart

REF: EBSTPC.1

WALL CHARTS

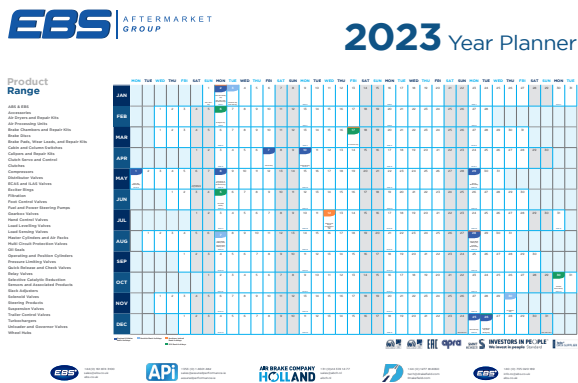

Year Planner
(Details UK Public Holidays)
REF: EBSYP.2

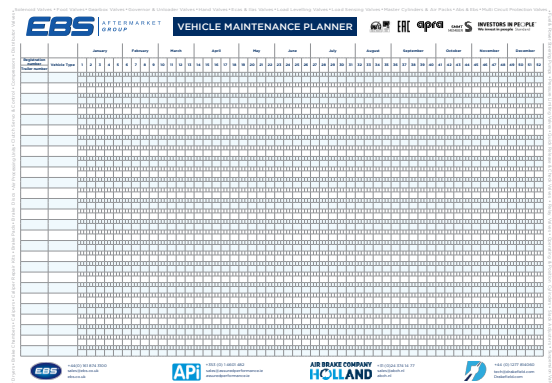

Vehicle Maintenance Planner
REF: EBSVMP.1

BRAKE CHAMBER ALIGNMENT TOOL

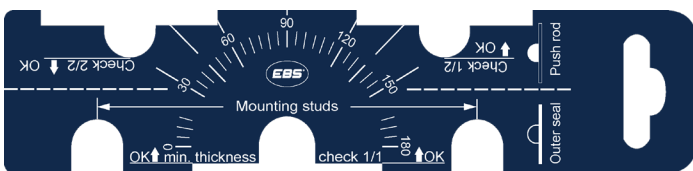

Brake Chamber Alignment Tool
REF: EBS.BCAT

Scan the QR Code to find out more about EBS.BCAT Alignment Tool instructions.



PROMOTIONAL MERCHANDISE*

*Available to purchase directly from EBS



EBS JACKET
REF: EBSJACKET

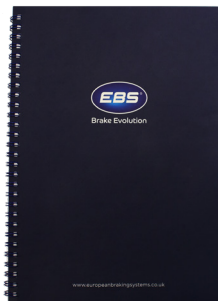

EBS NOTEBOOK
REF: EBSNBK.1



COUNTER TOP MAT
REF: EBS.COUNTMAT



EBS BOTTLE
REF: EBS.BOTTLE



EBS PEN
REF: EBSPEN1.1



EBS PHONE CHARGER
REF: EBS.CHARGERS



EBS USB DRIVE
REF: EBSUSB



EBS POST-IT NOTES
REF: EBSPIN1.1



EBS COASTER
REF: EBSGTC1.1



EBS COFFEE MUG
REF: EBSMUG1.1



EBS RULER
REF: EBSRLR1.1

PROMOTIONAL PRODUCTS



EBS

Our commitment to excellence

Our expertise is built on 20+ years' experience in air brake and vehicle control system components powered by innovation, smart design, and responsiveness to customers' enquiries. This allows our brand to provide the highest quality products and service to all our customers worldwide.

CONTENTS

Air Dryers and Repair Kits	1.1
Brake Chambers and Repair Kits	2.1
Calipers and Repair Kits	3.1
Brake Pads, Wear Leads and Repair Kits	3.A
Air Processing Units	4.1
Clutch Servo and Control	5.1
Compressors	6.1
Distributor Valves	7.1
Solenoid Valves	8.1
Foot Control Valves	9.1
Gearbox Valves	10.1
Unloader and Governor Valves	11.1
Hand Control Valves	12.1
ECAS & ILAS Valves	13.1
Load Levelling Valves	14.1
Load Sensing Valves	15.1
Master Cylinders and Air Packs	16.1
ABS and EBS	17.1

■ ■ ■

Multi Circuit Protection Valves	18.1
Fuel and Power Steering Pumps	20.1
Pressure Limiting Valves	21.1
Quick Release and Check Valves	22.1
Relay Valves	23.1
Operating and Position Cylinders	24.1
Slack Adjusters	25.1
Suspension Valves	26.1
Trailer Control Valves	27.1
Steering Products	29.1
Sensors and Associated Products	30.1
Exciter Rings	31.1
Oil Seals	32.1
Wheel Hubs	33.1
Selective Catalytic Reduction	34.1
Accessories	90.1

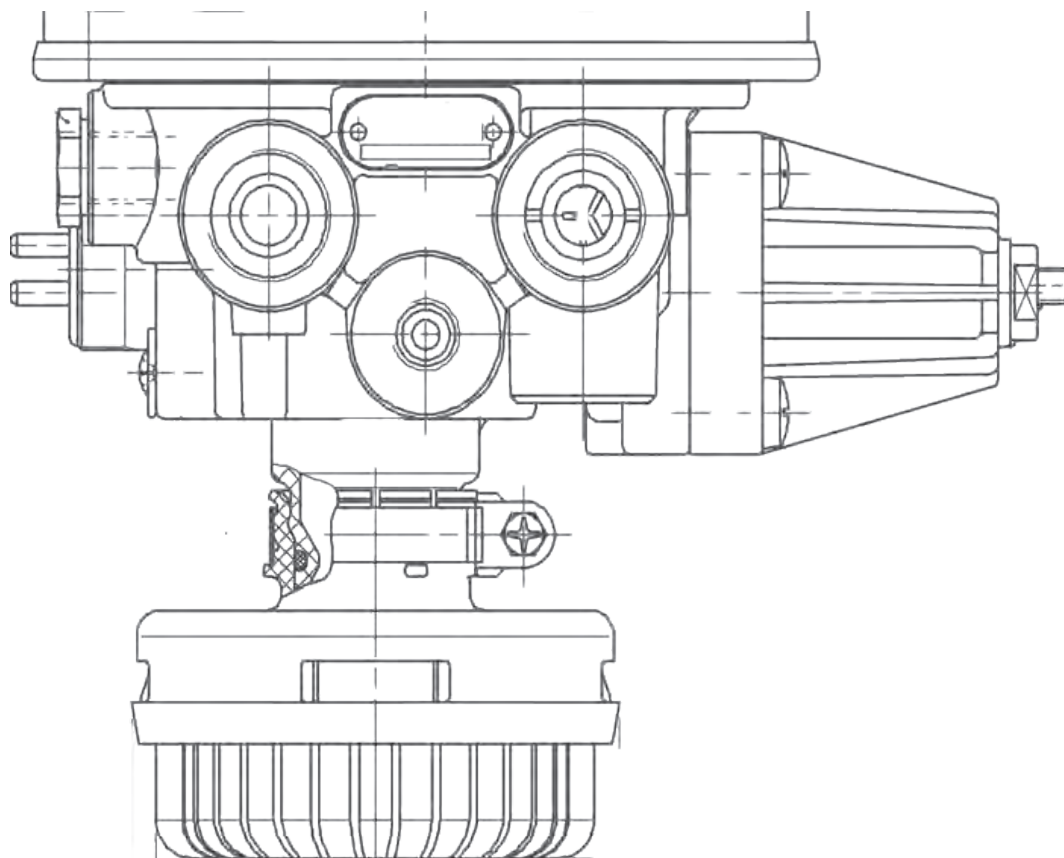

1



2



3



4

**EBS BOSCH AIR DRYERS**

EBS Part No	Image	Alternative Part No	Filter	Heater	Repair Kit	Repair Kit
---	2	0484460022000	EBS2227F	EKKB.63.7	EKBO.63	EKBO.63.1
---	2	0484460023000	EBS2227F	---	EKBO.63	EKBO.63.1
01.04.1530	1	0484460153000	EBS2227F	EKKB.63.7	EKBO.63	EKBO.63.1
---	1	0484460165000	EBS2227F	---	EKBO.63	EKBO.63.1
R01.04.1700	1	0484460170000	EBS2227F	---	EKBO.63	EKBO.63.1
---	1	0484460177000	EBS2227F	EKKB.63.7	EKBO.63	EKBO.63.1
---	1	0484460186000	EBS2227F	EKKB.63.77	EKBO.63	EKBO.63.1
---	1	0484460204000	EBS2227F	---	EKBO.63	EKBO.63.1

EBS BOSCH ELC AIR DRYERS

EBS Part No	Image	Alternative Part No	Filter	Heater	Repair Kit	Repair Kit
R01.04.2407	01.04.2407	3	0501100407100	EBS1507F	---	EKBO.63.4
R01.04.2408	01.04.2408	3	0501100408000	EBS1507F	---	EKBO.63.4

EBS HALDEX AIR DRYERS - SINGLE "SD"

EBS Part No	Image	Alternative Part No	Filter
---	4	71230	EBS1059F
---	4	71239	EBS1059F
---	4	71240	EBS1059F

5



5.1

**EBS HALDEX AIR DRYERS - SINGLE "SDX"**

EBS Part No	Image	Alternative Part No	Filter	Coalescing Filter Option	Heater	Repair Kit
---	5	78127	EBS8964F	EBS3522F	77244S	EKGH.64.8
01.03.1005	5	78217	EBS8964F	EBS3522F	---	EKGH.64.8
01.03.1006	5	78219	EBS8964F	EBS3522F	---	EKGH.64.8
01.03.1003	5	78984	EBS8964F	EBS3522F	78150S	EKGH.64.8
01.03.1002	5	78985 (87295)	EBS8964F	EBS3522F	78150S	EKGH.64.8
R01.03.1007	5	78986	EBS8964F	EBS3522F	78150S	EKGH.64.8
01.03.1001	5	78988 / 78650 / 87296	EBS8964F	EBS3522F	---	EKGH.64.8
01.03.1000	5	78990	EBS8964F	EBS3522F	---	EKGH.64.8
01.03.1008	5	87189	EBS8964F	EBS3522F	---	EKGH.64.8
01.03.1009	5	87282	EBS8964F	EBS3522F	---	EKGH.64.8
01.03.1010	5	93096	EBS8964F	EBS3522F	---	EKGH.64.8
01.03.1011	5	93097	EBS8964F	EBS3522F	---	EKGH.64.8
01.03.1012	5	93729	EBS8964F	EBS3522F	30v Deutsch	EKGH.64.8
01.03.1016	5	90548	EBS8964F	EBS3522F	---	EKGH.64.8

EBS HALDEX DEPOT VALVE

EBS Part No	Image	Alternative Part No
R01.03.4001	6.1	78682

EBS HALDEX ECAM AIR DRYERS

EBS Part No	Image	Alternative Part No	Filter	Heater	Repair Kit	Repair Kit
---	5.1	950310014	EBS2227F	---	EKGH.64.9	---

6



6.1



7



8



EBS HALDEX AIR DRYER BLACK BOX

EBS Part No	Image	Alternative Part No
01.03.2000	6	87346S
01.03.2001	6	87347S
01.03.2002	6	78703S
01.03.2003	6	78717S
01.03.2004	6	78949S
01.03.2005	6	87332S
01.03.2006	6	93101S
01.03.2007	6	93102S
01.03.2008	6	78104S
01.03.2009	6	87348S
01.03.2010	6	90216S

EBS HALDEX AIR DRYERS - TWIN

EBS Part No	Image	Alternative Part No	Filter
---	7	71200	EBS1034F
---	7	71201	EBS1034F
---	7	71202	EBS1034F
---	7	71203	EBS1034F
R01.03.1004	7	71206	EBS1034F
---	7	71208	EBS1034F
---	7	71209	EBS1034F
---	7	71215	EBS1034F
---	7	71216	EBS1034F
---	7	83377	EBS1034F
---	7	83378	EBS1034F
---	7	83379	EBS1034F

EBS AD2 AIR DRYERS

EBS Part No	Image	Alternative Part No	Repair Kit
R01.06.1000	8	267121	EKBE.64
R01.06.1001	8	269827	EKBE.62

9



EBS KNORR AIR DRYERS - LA62 SERIES

EBS Part No	Image	Alternative Part No	Filter	Heater	Repair Kit	Repair Kit
01.02.1205	9	LA6205	EBS2227F	---	EKKB.63	EKKB.63.P
01.02.1206	9	LA6206	EBS2227F	EKKB.63.80	EKKB.63	EKKB.63.P
01.02.1208	9	LA6208	EBS2227F	---	EKKB.63	EKKB.63.P
01.02.1210	9	LA6210	EBS2227F	EKKB.63.7	EKKB.63	EKKB.63.P
01.02.1211	9	LA6211	EBS2227F	---	EKKB.63	EKKB.63.P
01.02.1212	9	LA6212	EBS2227F	---	EKKB.63	EKKB.63.P
01.02.1217	9	LA6217	EBS2227F	EKKB.63.7	EKKB.63	EKKB.63.P
01.02.1221	9	LA6221	EBS2227F	---	EKKB.63	EKKB.63.P
01.02.1222	9	LA6222	EBS2227F	EKKB.63.7	EKKB.63	EKKB.63.P
01.02.1226	9	LA6226	EBS2227F	EKKB.63.77	EKKB.63	EKKB.63.P
01.02.1227	9	LA6227	EBS2227F	EKKB.63.7	EKKB.63	EKKB.63.P
01.02.1277	9	LA6277	EBS2227F	---	EKKB.63	EKKB.63.P

EBS KNORR AIR DRYERS - LA67 SERIES

EBS Part No	Image	Alternative Part No	Filter	Heater	Repair Kit	Repair Kit
01.02.1700	9	LA6700	EBS2227F	---	EKKB.63	EKKB.63.P
01.02.1709	9	LA6709	EBS2227F	EKKB.63.7	EKKB.63	EKKB.63.P
01.02.1710	9	LA6710	EBS2227F	EKKB.63.19	EKKB.63	EKKB.63.P
01.02.1711	9	LA6711	EBS2227F	EKKB.63.7	EKKB.63	EKKB.63.P
01.02.1734	9	LA6734	EBS2227F	---	EKKB.63	EKKB.63.P
01.02.1735	9	LA6735	EBS2227F	EKKB.63.7	EKKB.63	EKKB.63.P

AIR DRYERS & REPAIR KITS

10



11



12



13



EBS KNORR AIR DRYERS - LA80 SERIES

EBS Part No	Image	Alternative Part No	Filter	Heater	Repair Kit	Repair Kit	Repair Kit	Repair Kit
01.02.2001	10	LA8001	EBS2227F	EKKB.63.23	EKKB.63	EKKB.63.P	EKKB.63.3.P	EKKB.63.2U
01.02.2002	10	LA8002	EBS2227F	EKKB.63.7	EKKB.63	EKKB.63.P	EKKB.63.3.P	EKKB.63.2U
01.02.2003	10	LA8003	EBS2227F	EKKB.63.7	EKKB.63	EKKB.63.P	EKKB.63.3.P	EKKB.63.2U
01.02.2004	10	LA8004	EBS2227F	EKKB.63.7	EKKB.63	EKKB.63.P	EKKB.63.3.P	EKKB.63.2U
01.02.2006	10	LA8006	EBS2227F	EKKB.63.7	EKKB.63	EKKB.63.P	EKKB.63.3.P	EKKB.63.2U
01.02.2007	10	LA8007	EBS2227F	EKKB.63.7	EKKB.63	EKKB.63.P	EKKB.63.3.P	EKKB.63.2U
01.02.2008	10	LA8008	EBS2227F	EKKB.63.7	EKKB.63	EKKB.63.P	EKKB.63.3.P	EKKB.63.2U
01.02.2011	10	LA8011	EBS2227F	---	EKKB.63	EKKB.63.P	EKKB.63.3.P	EKKB.63.2U
01.02.2015	10	LA8015	EBS2227F	---	EKKB.63	EKKB.63.P	EKKB.63.3.P	EKKB.63.2U
01.02.2016	10	LA8016	EBS2227F	---	EKKB.63	EKKB.63.P	EKKB.63.3.P	EKKB.63.2U
01.02.2025	10	LA8025	EBS2227F	---	EKKB.63	EKKB.63.P	EKKB.63.3.P	EKKB.63.2U
01.02.2030	10	LA8030	EBS2227F	EKKB.63.7	EKKB.63	EKKB.63.P	EKKB.63.3.P	EKKB.63.2U
01.02.2040	10	LA8040	EBS2227F	---	EKKB.63	EKKB.63.P	EKKB.63.3.P	EKKB.63.2U
01.02.2041	10	LA8041	EBS2227F	---	EKKB.63	EKKB.63.P	EKKB.63.3.P	EKKB.63.2U
01.02.2044	10	LA8044	EBS2227F	---	EKKB.63	EKKB.63.P	EKKB.63.3.P	EKKB.63.2U
01.02.2047	10	LA8047	EBS2227F	---	EKKB.63	EKKB.63.P	EKKB.63.3.P	EKKB.63.2U
01.02.2048	10	LA8048	EBS2227F	EKKB.63.7	EKKB.63	EKKB.63.P	EKKB.63.3.P	EKKB.63.2U
01.02.2050	10	LA8050	EBS2227F	EKKB.63.7	EKKB.63	EKKB.63.P	EKKB.63.3.P	EKKB.63.2U
01.02.2060	10	LA8060	EBS2227F	EKKB.63.7	EKKB.63	EKKB.63.P	EKKB.63.3.P	EKKB.63.2U
01.02.2061	10	LA8061	EBS2227F	EKKB.63.78	EKKB.63	EKKB.63.P	EKKB.63.3.P	EKKB.63.2U
01.02.2063	10	LA8063	EBS2227F	EKKB.63.78	EKKB.63	EKKB.63.P	EKKB.63.3.P	EKKB.63.2U
01.02.2064	10	LA8064	EBS2227F	EKKB.63.78	EKKB.63	EKKB.63.P	EKKB.63.3.P	EKKB.63.2U
01.02.2065	10	LA8065	EBS2227F	EKKB.63.78	EKKB.63	EKKB.63.P	EKKB.63.3.P	EKKB.63.2U
01.02.2069	10	LA8069	EBS2227F	EKKB.63.78	EKKB.63	EKKB.63.P	EKKB.63.3.P	EKKB.63.2U
01.02.2073	10	LA8073	EBS2227F	EKKB.63.78	EKKB.63	EKKB.63.P	EKKB.63.3.P	EKKB.63.2U
01.02.2074	10	K016602N00/LA8074	EBS2232F	EKKB.63.78	EKKB.63	---	---	---

EBS KNORR AIR DRYERS - LA81 SERIES

EBS Part No	Image	Alternative Part No	Filter	Heater	Repair Kit	Repair Kit
01.02.4104	11	LA8104	EBS2227F	EKKB.63.78	EKKB.63.3	EKKB.63.3.P
01.02.4105	11	LA8105	EBS2227F	---	EKKB.63.3	EKKB.63.3.P
01.02.4106	11	LA8106	EBS2227F	EKKB.63.78	EKKB.63.3	EKKB.63.3.P
01.02.4107	11	LA8107	EBS2227F	---	EKKB.63.3	EKKB.63.3.P
01.02.4124	11	LA8124	EBS2227F	EKKB.63.78	EKKB.63.3	EKKB.63.3.P
01.02.4125	11	LA8125	EBS2227F	EKKB.63.78	EKKB.63.3	EKKB.63.3.P
01.02.4126	11	LA8126	EBS2227F	EKKB.63.78	EKKB.63.3	EKKB.63.3.P
01.02.4127	11	LA8127	EBS2227F	EKKB.63.78	EKKB.63.3	EKKB.63.3.P
01.02.4128	11	LA8128	EBS2227F	EKKB.63.78	EKKB.63.3	EKKB.63.3.P
01.02.4129	11	LA8129	EBS2227F	EKKB.63.78	EKKB.63.3	EKKB.63.3.P
01.02.4113	12	LA8113	EBS4525F	EKKB.63.78	EKKB.63.3	EKKB.63.3.P
01.02.4116	12	LA8116	EBS4525F	EKKB.63.78	EKKB.63.3	EKKB.63.3.P
01.02.4117	12	LA8117	EBS4525F	EKKB.63.78	EKKB.63.3	EKKB.63.3.P

EBS KNORR AIR DRYERS - LA81 SERIES

EBS Part No	Image	Alternative Part No	Filter	Heater	Repair Kit	Repair Kit
01.02.4119	12	LA8119	EBS4525F	EKKB.63.78	EKKB.63.3	EKKB.63.3.P
01.02.4130	12	LA8130	EBS4525F	EKKB.63.78	EKKB.63.3	EKKB.63.3.P
01.02.4131	12	LA8131	EBS4525F	EKKB.63.78	EKKB.63.3	EKKB.63.3.P
01.02.4132	12	LA8132	EBS4525F	EKKB.63.78	EKKB.63.3	EKKB.63.3.P
01.02.4134	12	LA8134	EBS4525F	EKKB.63.78	EKKB.63.3	EKKB.63.3.P
01.02.4137	12	LA8137	EBS4525F	EKKB.63.78	EKKB.63.3	EKKB.63.3.P
01.02.4138	12	LA8138	EBS4525F	EKKB.63.78	EKKB.63.3	EKKB.63.3.P
01.02.4140	11	LA8140	EBS2227F	EKKB.63.78	EKKB.63.3	EKKB.63.3.P
01.02.4145	12	LA8145	EBS9455F	EKKB.63.78	EKKB.63.3	EKKB.63.3.P
01.02.4146	12	LA8146	EBS9455F	EKKB.63.78	EKKB.63.3	EKKB.63.3.P
01.02.4147	12	LA8147	EBS9455F	EKKB.63.78	EKKB.63.3	EKKB.63.3.P
01.02.4148	12	LA8148	EBS9455F	EKKB.63.78	EKKB.63.3	EKKB.63.3.P

EBS KNORR AIR DRYERS - LA82 SERIES

EBS Part No	Image	Alternative Part No	Filter	Heater	Repair Kit	Repair Kit
01.02.4200	13	LA8200	EBS2227F	EKKB.63.7	EKKB.63	EKKB.63.2U
01.02.4201	13	LA8201	EBS2227F	EKKB.63.7	EKKB.63	EKKB.63.2U
01.02.4202	13	LA8202	EBS2227F	EKKB.63.7	EKKB.63	EKKB.63.2U
01.02.4203	13	LA8203	EBS2227F	---	EKKB.63	EKKB.63.2U
01.02.4205	13	LA8205	EBS2227F	---	EKKB.63	EKKB.63.2U
01.02.4206	13	LA8206	EBS2227F	EKKB.63.77	EKKB.63	EKKB.63.2U
01.02.4208	13	LA8208	EBS2227F	EKKB.63.78	EKKB.63	EKKB.63.2U
01.02.4209	13	LA8209	EBS2227F	---	EKKB.63	EKKB.63.2U
01.02.4210	13	LA8210	EBS2227F	EKKB.63.78	EKKB.63	EKKB.63.2U
01.02.4211	13	LA8211	EBS2227F	---	EKKB.63	EKKB.63.2U
01.02.4212	13	LA8212	EBS2227F	EKKB.63.78	EKKB.63	EKKB.63.2U
01.02.4219	13	LA8219	EBS2227F	---	EKKB.63	EKKB.63.2U
01.02.4220	13	LA8220	EBS2227F	EKKB.63.77	EKKB.63	EKKB.63.2U
01.02.4221	13	LA8221	EBS2227F	---	EKKB.63	EKKB.63.2U
01.02.4222	13	LA8222	EBS2227F	EKKB.63.77	EKKB.63	EKKB.63.2U
01.02.4223	13	LA8223	EBS2227F	EKKB.63.7	EKKB.63	EKKB.63.2U
01.02.4224	13	LA8224	EBS2227F	EKKB.63.77	EKKB.63	EKKB.63.2U
01.02.4225	13	LA8225	EBS2227F	EKKB.63.7	EKKB.63	EKKB.63.2U
01.02.4226	13	LA8226	EBS2227F	EKKB.63.7	EKKB.63	EKKB.63.2U
01.02.4227	13	LA8227	EBS2227F	EKKB.63.7	EKKB.63	EKKB.63.2U
01.02.4229	13	LA8229	EBS2227F	---	EKKB.63	EKKB.63.2U
01.02.4231	13	LA8231	EBS2227F	---	EKKB.63	EKKB.63.2U
01.02.4233	13	LA8233	EBS2227F	EKKB.63.80	EKKB.63	EKKB.63.2U
01.02.4234	13	LA8234	EBS2227F	EKKB.63.7	EKKB.63	EKKB.63.2U
01.02.4243	13	LA8243	EBS2227F	EKKB.63.7	EKKB.63	EKKB.63.2U
01.02.4256	13	LA8256	EBS2227F	EKKB.63.77	EKKB.63	EKKB.63.2U
01.02.4259	13	LA8259	EBS2227F	EKKB.63.7	EKKB.63	EKKB.63.2U
01.02.4263	13	LA8263	EBS2227F	EKKB.63.78	EKKB.63	EKKB.63.2U
01.02.4267	13	LA8267	EBS2227F	EKKB.63.7	EKKB.63	EKKB.63.2U
01.02.4270	13	LA8270	EBS2227F	EKKB.63.7	EKKB.63	EKKB.63.2U
01.02.4271	13	LA8271	EBS2227F	EKKB.63.19	EKKB.63	EKKB.63.2U
01.02.4272	13	LA8272	EBS2227F	EKKB.63.78	EKKB.63	EKKB.63.2U
01.02.4273	13	LA8273	EBS2227F	EKKB.63.78	EKKB.63	EKKB.63.2U
01.02.4280	13	LA8280	EBS2227F	EKKB.63.79	EKKB.63	EKKB.63.2U
01.02.4283	13	LA8283	EBS2227F	EKKB.63.7	EKKB.63	EKKB.63.2U
01.02.4284	13	LA8284	EBS2227F	EKKB.63.78	EKKB.63	EKKB.63.2U
01.02.4286	13	LA8286	EBS2227F	EKKB.63.19	EKKB.63	EKKB.63.2U
01.02.4298	13	LA8298	EBS2227F	EKKB.63.7	EKKB.63	EKKB.63.2U

**EBS KNORR AIR DRYERS - LA86 SERIES**

EBS Part No	Image	Alternative Part No	Filter	Heater	Repair Kit	Repair Kit
01.02.9600	14	K043684N50/LA8600	EBS2227F	EKKB.63.81	EKKB.63.4	EKKB.63.44
01.02.9603	14	K039118N50/LA8603	EBS2232F	EKKB.63.78	EKKB.63.4	EKKB.63.44
01.02.9605	14	K039120N50, LA8605	EBS2227F	EKKB.63.81	EKKB.63.4	EKKB.63.44
01.02.9606	14	K040604N50/LA8606	EBS2232F	EKKB.63.78	EKKB.63.4	EKKB.63.44
01.02.9607	14	K040605N50/LA8607	EBS2232F	EKKB.63.78	EKKB.63.4	EKKB.63.44
01.02.9608	14	K040606N50/LA8608	EBS2232F	EKKB.63.78	EKKB.63.4	EKKB.63.44
01.02.9609	14	K040607N50 /LA8609	EBS2232F	EKKB.63.78	EKKB.63.4	EKKB.63.44
01.02.9610	14	K040608N50/LA8610	EBS2232F	EKKB.63.78	EKKB.63.4	EKKB.63.44
01.02.9617	14	K044300N50/LA8617	EBS4525F	EKKB.63.81	EKKB.63.4	EKKB.63.44
01.02.9635	15	K116869N50/LA8635	EBS4525F	EKKB.63.81	EKKB.63.4	90.04.1000
01.02.9636	15	K116870N50/LA8636	EBS2232F	EKKB.63.81	EKKB.63.4	90.04.1000
01.02.9637	15	K1168871N50/LA8637	EBS4525F	EKKB.63.81	EKKB.63.4	90.04.1000
01.02.9642	15	K116876N50/LA8642	EBS9455F	EKKB.63.81	EKKB.63.4	90.04.1000
01.02.9643	15	K116877N50/LA8643	EBS2232F	EKKB.63.81	EKKB.63.4	90.04.1000
01.02.9644	15	K116878N50/LA8644	EBS9455F	EKKB.63.81	EKKB.63.4	90.04.1000
01.02.9645	15	K116879N50/LA8645	EBS4525F	EKKB.63.81	EKKB.63.4	90.04.1000
01.02.9646	15	K116880N50/LA8646	EBS2232F	EKKB.63.81	EKKB.63.4	90.04.1000

EBS KNORR AIR DRYERS - LA87 SERIES

EBS Part No	Image	Alternative Part No	Filter	Heater	Repair Kit	Repair Kit
01.02.5700	16	LA8700	EBS2227F	EKKB.63.7	EKKB.63	EKKB.63.P
01.02.5708	16	LA8708	EBS2227F	EKKB.63.7	EKKB.63	EKKB.63.P

EBS KNORR AIR DRYERS - LA90 SERIES

EBS Part No	Image	Alternative Part No	Filter	Heater	Repair Kit	Repair Kit
01.02.6000	17	LA9000	EBS2227F	EKKB.63.24	EKKB.63.2	---
01.02.6001	17	LA9001	EBS2227F	---	EKKB.63.2	---
01.02.6002	17	LA9002	EBS2227F	---	EKKB.63.2	---
01.02.6004	17	LA9004	EBS2227F	EKKB.63.24	EKKB.63.2	---
01.02.6010	17	LA9010	EBS2227F	EKKB.63.24	EKKB.63.2	---
01.02.6011	17	LA9011	EBS2227F	---	EKKB.63.2	---
01.02.6018	17	LA9018	EBS2227F	EKKB.63.24	EKKB.63.2	---
01.02.6024	17	LA9024	EBS2232F	EKKB.63.24	EKKB.63.2	---
01.02.6034	17	LA9034	EBS2232F	EKKB.63.24	EKKB.63.2	---
01.02.6035	17	LA9035	EBS2232F	EKKB.63.24	EKKB.63.2	---

KNORR AIR DRYER - EL90 SERIES

EBS Part No	Image	Alternative Part No	Filter	Heater	Repair Kit	Repair Kit
01.02.10003	18	EL9002 K011867N00	EBS2227F	EKKB.63.24	EKKB.63.18	---

KNORR AIR DRYER - ELA1000 SERIES

EBS Part No	Image	Alternative Part No	Filter	Heater	Repair Kit	Repair Kit
---	20	ELA1000 K075169	EBS6383F	---	EKKB.63.17	---

EBS WABCO AIR DRYERS - 432410 SERIES

EBS Part No	Image	Alternative Part No	Filter	Heater	Repair Kit	Repair Kit	Repair Kit	Repair Kit
01.01.1000	19	4324100000	EBS2227F	EKWA.63.7	EKWA.63.4	EKWA.63.5	EKWA.63.24	EKWA.63.45
01.01.1005	19	4324100050	EBS2227F	---	EKWA.63.4	EKWA.63.5	EKWA.63.24	EKWA.63.45
01.01.1007	19	4324100070	EBS2227F	EKWA.63.7	EKWA.63.4	EKWA.63.5	EKWA.63.24	EKWA.63.45
01.01.1010	19	4324100100	EBS2227F	EKWA.63.23	EKWA.63.4	EKWA.63.5	EKWA.63.24	EKWA.63.45
01.01.1011	19	4324100110	EBS2227F	EKWA.63.23	EKWA.63.4	EKWA.63.5	EKWA.63.24	EKWA.63.45
01.01.1020	19	4324100200	EBS2227F	EKWA.63.7	EKWA.63.4	EKWA.63.5	EKWA.63.24	EKWA.63.45
01.01.1021	19	4324100210	EBS2227F	---	EKWA.63.4	EKWA.63.5	EKWA.63.24	EKWA.63.45
01.01.1022	19	4324100220	EBS2227F	EKWA.63.7	EKWA.63.4	EKWA.63.5	EKWA.63.24	EKWA.63.45
01.01.1023	19	4324100230	EBS2227F	---	EKWA.63.4	EKWA.63.5	EKWA.63.24	EKWA.63.45
01.01.1026	19	4324100260	EBS2227F	EKWA.63.7	EKWA.63.4	EKWA.63.5	EKWA.63.24	EKWA.63.45
01.01.1027	19	4324100270	EBS2227F	EKWA.63.7	EKWA.63.4	EKWA.63.5	EKWA.63.24	EKWA.63.45
01.01.1028	19	4324100280	EBS2227F	EKWA.63.7	EKWA.63.4	EKWA.63.5	EKWA.63.24	EKWA.63.45
01.01.1033	19	4324100330	EBS2227F	---	EKWA.63.4	EKWA.63.5	EKWA.63.24	EKWA.63.45
01.01.1034	19	4324100340	EBS2227F	EKWA.63.14	EKWA.63.4	EKWA.63.5	EKWA.63.24	EKWA.63.45
01.01.1037	19	4324100370	EBS2227F	---	EKWA.63.4	EKWA.63.5	EKWA.63.24	EKWA.63.45
01.01.1042	19	4324100420	EBS2227F	EKWA.63.7	EKWA.63.4	EKWA.63.5	EKWA.63.24	EKWA.63.45
01.01.1049	19	4324100490	EBS2227F	EKWA.63.7	EKWA.63.4	EKWA.63.5	EKWA.63.24	EKWA.63.45
01.01.1050	19	4324100500	EBS2227F	EKWA.63.7	EKWA.63.4	EKWA.63.5	EKWA.63.24	EKWA.63.45
01.01.1066	19	4324100660	EBS2227F	---	EKWA.63.4	EKWA.63.5	EKWA.63.24	EKWA.63.45
01.01.1067	19	4324100670	EBS2227F	EKWA.63.7	EKWA.63.4	EKWA.63.5	EKWA.63.24	EKWA.63.45
01.01.1069	19	4324100690	EBS2227F	EKWA.63.7	EKWA.63.4	EKWA.63.5	EKWA.63.24	EKWA.63.45
01.01.1072	19	4324100720	EBS2227F	EKWA.63.19	EKWA.63.4	EKWA.63.5	EKWA.63.24	EKWA.63.45
01.01.1074	19	4324100740	EBS2227F	---	EKWA.63.4	EKWA.63.5	EKWA.63.24	EKWA.63.45
01.01.1076	19	4324100760	EBS2227F	EKWA.63.30	EKWA.63.4	EKWA.63.5	EKWA.63.24	EKWA.63.45
01.01.1077	19	4324100770	EBS2227F	---	EKWA.63.4	EKWA.63.5	EKWA.63.24	EKWA.63.45
01.01.1079	19	4324100790	EBS2227F	EKWA.63.7	EKWA.63.4	EKWA.63.5	EKWA.63.24	EKWA.63.45
01.01.1080	19	4324100800	EBS2227F	EKWA.63.7	EKWA.63.4	EKWA.63.5	EKWA.63.24	EKWA.63.45
01.01.1083	19	4324100830	EBS9272F	EKWA.63.23	EKWA.63.4	EKWA.63.5	EKWA.63.24	EKWA.63.45
01.01.1085	19	4324100850	EBS2227F	EKWA.63.30	EKWA.63.4	EKWA.63.5	EKWA.63.24	EKWA.63.45
01.01.1086	19	4324100860	EBS2232F	EKWA.63.30	EKWA.63.4	EKWA.63.5	EKWA.63.24	EKWA.63.45
01.01.1087	19	4324100870	EBS2227F	EKWA.63.19	EKWA.63.4	EKWA.63.5	EKWA.63.24	EKWA.63.45
01.01.1101	19	4324101010	EBS2227F	---	EKWA.63.4	EKWA.63.5	EKWA.63.24	EKWA.63.45
01.01.1102	19	4324101020	EBS2227F	EKWA.63.7	EKWA.63.4	EKWA.63.5	EKWA.63.24	EKWA.63.45
01.01.1104	19	4324101040	EBS2227F	EKWA.63.7	EKWA.63.4	EKWA.63.5	EKWA.63.24	EKWA.63.45
01.01.1110	19	4324101100	EBS2227F	EKWA.63.14	EKWA.63.4	EKWA.63.5	EKWA.63.24	EKWA.63.45
01.01.1112	19	4324101120	EBS2227F	EKWA.63.30	EKWA.63.4	EKWA.63.5	EKWA.63.24	EKWA.63.45
01.01.1113	19	4324101130	EBS2227F	---	EKWA.63.4	EKWA.63.5	EKWA.63.24	EKWA.63.45
01.01.1114	19	4324101140	EBS2227F	EKWA.63.30	EKWA.63.4	EKWA.63.5	EKWA.63.24	EKWA.63.45
01.01.1116	19	4324101160	EBS2227F	EKWA.63.30	EKWA.63.4	EKWA.63.5	EKWA.63.24	EKWA.63.45
01.01.1117	19	4324101170	EBS2227F	---	EKWA.63.4	EKWA.63.5	EKWA.63.24	EKWA.63.45
01.01.1122	19	4324101220	EBS2227F	EKWA.63.7	EKWA.63.4	EKWA.63.5	EKWA.63.24	EKWA.63.45
01.01.1123	19	4324101230	EBS2227F	---	EKWA.63.4	EKWA.63.5	EKWA.63.24	EKWA.63.45
01.01.1127	19	4324101270	EBS2227F	EKWA.63.42	EKWA.63.4	EKWA.63.5	EKWA.63.24	EKWA.63.45
01.01.1129	19	4324101290	EBS2227F	EKWA.63.42	EKWA.63.4	EKWA.63.5	EKWA.63.24	EKWA.63.45
01.01.1134	19	4324101340	EBS2227F	EKWA.63.30	EKWA.63.4	EKWA.63.5	EKWA.63.24	EKWA.63.45
01.01.1144	19	4324101440	EBS9272F	EKWA.63.23	EKWA.63.4	EKWA.63.5	EKWA.63.24	EKWA.63.45
01.01.1155	19	4324101550	EBS2227F	EKWA.63.7	EKWA.63.4	---	---	---
01.01.1169	19	4324101690	EBS2232F	EKWA.63.7	EKWA.63.4	EKWA.63.5	EKWA.63.24	EKWA.63.45
01.01.1191	19	4324101910	EBS2232F	EKWA.63.30	EKWA.63.4	EKWA.63.5	EKWA.63.24	EKWA.63.45
01.01.1192	19	4324101920	EBS2232F	EKWA.63.30	EKWA.63.4	EKWA.63.5	EKWA.63.24	EKWA.63.45
01.01.1200	19	4324102000	EBS2227F	EKWA.63.14	EKWA.63.4	EKWA.63.5	EKWA.63.24	EKWA.63.45

AIR DRYERS & REPAIR KITS

19



20A



21



22



23



EBS WABCO AIR DRYERS - 432410 SERIES

EBS Part No	Image	Alternative Part No	Filter	Heater	Repair Kit	Repair Kit	Repair Kit	Repair Kit
01.01.1201	19	4324102010	EBS2227F	EKWA.63.7	EKWA.63.4	EKWA.63.5	EKWA.63.24	EKWA.63.45
01.01.1204	19	4324102040	EBS2227F	---	EKWA.63.4	EKWA.63.5	EKWA.63.24	EKWA.63.45
01.01.1250	19	4324102500	EBS2227F	EKWA.63.14	EKWA.63.4	EKWA.63.5	EKWA.63.24	EKWA.63.45
01.01.1252	19	4324102520	EBS2227F	EKWA.63.7	EKWA.63.4	EKWA.63.5	EKWA.63.24	EKWA.63.45
01.01.1720	19	4324107200	EBS2232F	---	EKWA.63.4	EKWA.63.5	EKWA.63.24	EKWA.63.45
01.01.1735	19	4324107350	EBS2232F	---	EKWA.63.4	EKWA.63.5	EKWA.63.24	EKWA.63.45
01.01.1907	19	4324109070	EBS2232F	EKWA.63.7	EKWA.63.4	EKWA.63.5	EKWA.63.24	EKWA.63.45

EBS WABCO AIR DRYERS - 432411 SERIES

EBS Part No	Image	Alternative Part No	Filter	Heater	Repair Kit
01.01.D168	20A	4324111680	EBS2227F	EKWA.63.7	EKWA.63.7

EBS WABCO AIR DRYERS - 432415 SERIES

EBS Part No	Image	Alternative Part No	Filter	Heater	Repair Kit	Repair Kit	Repair Kit
01.01.2000	21	4324150000	EBS2227F	EKWA.63.7	EKWA.63.5	EKWA.63.20	EKWA.63.24
01.01.2003	21	4324150030	EBS2227F	EKWA.63.7	EKWA.63.5	EKWA.63.20	EKWA.63.24
01.01.2004	21	4324150040	EBS2227F	EKWA.63.7	EKWA.63.5	EKWA.63.20	EKWA.63.24
01.01.2005	21	4324150050	EBS2227F	EKWA.63.7	EKWA.63.5	EKWA.63.20	EKWA.63.24
01.01.2006	21	4324150060	EBS2227F	EKWA.63.7	EKWA.63.5	EKWA.63.20	EKWA.63.24
01.01.2013	21	4324150130	EBS2227F	EKWA.63.7	EKWA.63.5	EKWA.63.20	EKWA.63.24
01.01.2014	21	4324150140	EBS2227F	EKWA.63.7	EKWA.63.5	EKWA.63.20	EKWA.63.24
01.01.2016	21	4324150160	EBS2227F	EKWA.63.7	EKWA.63.5	EKWA.63.20	EKWA.63.24
01.01.2017	21	4324150170	EBS2227F	EKWA.63.7	EKWA.63.5	EKWA.63.20	EKWA.63.24
01.01.2019	21	4324150190	EBS2227F	EKWA.63.7	EKWA.63.5	EKWA.63.20	EKWA.63.24
01.01.2020	21	4324150200	EBS2227F	---	EKWA.63.5	EKWA.63.20	EKWA.63.24
01.01.2022	21	4324150220	EBS2227F	---	EKWA.63.5	EKWA.63.20	EKWA.63.24
01.01.2024	21	4324150240	EBS2227F	---	EKWA.63.5	EKWA.63.20	EKWA.63.24
01.01.2025	21	4324150250	EBS2227F	---	EKWA.63.5	EKWA.63.20	EKWA.63.24
01.01.2026	21	4324150260	EBS2227F	---	EKWA.63.5	EKWA.63.20	EKWA.63.24
01.01.2028	21	4324150280	EBS2227F	---	EKWA.63.5	EKWA.63.20	EKWA.63.24
01.01.2029	21	4324150290	EBS2227F	EKWA.63.7	EKWA.63.5	EKWA.63.20	EKWA.63.24
01.01.2030	21	4324150300	EBS2227F	EKWA.63.7	EKWA.63.5	EKWA.63.20	EKWA.63.24
01.01.2032	21	4324150320	EBS2227F	EKWA.63.7	EKWA.63.5	EKWA.63.20	EKWA.63.24
01.01.2037	21	4324150370	EBS2227F	EKWA.63.30	EKWA.63.5	EKWA.63.20	EKWA.63.24
01.01.2051	21	4324150510	EBS2227F	EKWA.63.30	EKWA.63.5	EKWA.63.20	EKWA.63.24
01.01.2059	21	4324150590	EBS2227F	EKWA.63.30	EKWA.63.5	EKWA.63.20	EKWA.63.24
01.01.2138	21	4324151380	EBS2207F	---	EKWA.63.5	EKWA.63.20	EKWA.63.24
01.01.2904	21	4324159040	EBS2227F	EKWA.63.7	EKWA.63.5	EKWA.63.20	EKWA.63.24
01.01.2921	21	4324159210	EBS2227F	EKWA.63.79	EKWA.63.5	EKWA.63.20	EKWA.63.24



EBS WABCO AIR DRYERS - 432416 SERIES

EBS Part No	Image	Alternative Part No	Filter	Heater	Repair Kit	Repair Kit	Repair Kit
01.01.C004	22	4324160040	EBS2232F	---	---	---	---

EBS WABCO AIR DRYERS - 432420 SERIES

EBS Part No	Image	Alternative Part No	Filter	Heater	Repair Kit	Repair Kit	Repair Kit
01.01.3000	23	4324200000	EBS2227F	EKWA.63.7	EKWA.63.24	EKWA.63.5	---
01.01.3002	23	4324200020	EBS2227F	---	EKWA.63.24	EKWA.63.5	---
01.01.3008	23	4324200080	EBS2227F	EKWA.63.7	EKWA.63.24	EKWA.63.5	---
01.01.3100	23	4324201000	EBS2227F	EKWA.63.7	EKWA.63.24	EKWA.63.5	---

EBS WABCO AIR DRYERS - 432421 SERIES

EBS Part No	Image	Alternative Part No	Filter	Heater	Repair Kit	Repair Kit	Repair Kit
01.01.4000	24	4324210000	EBS2227F	EKWA.63.7	EKWA.63.24	EKWA.63.5	---
01.01.4002	24	4324210020	EBS2227F	---	EKWA.63.24	EKWA.63.5	---
01.01.4003	24	4324210030	EBS2227F	EKWA.63.7	EKWA.63.24	EKWA.63.5	---
01.01.4005	24	4324210050	EBS2227F	---	EKWA.63.24	EKWA.63.5	---
01.01.4007	24	4324210070	EBS2227F	EKWA.63.7	EKWA.63.24	EKWA.63.5	---
01.01.4008	24	4324210080	EBS2227F	---	EKWA.63.24	EKWA.63.5	---
01.01.4014	24	4324210140	EBS2227F	---	EKWA.63.24	EKWA.63.5	---
01.01.4025	24	4324210250	EBS2227F	---	EKWA.63.24	EKWA.63.5	---
01.01.4028	24	4324210280	EBS2227F	---	EKWA.63.24	EKWA.63.5	---
01.01.4032	24	4324210320	EBS2232F	8942600462	EKWA.63.24	EKWA.63.5	---

EBS WABCO AIR DRYERS - 432425 SERIES

EBS Part No	Image	Alternative Part No	Filter	Heater	Repair Kit	Repair Kit	Repair Kit
01.01.5101	25	4324251010	EBS2232F	EKWA.63.30	EKWA.63.31	EKWA.63.32	---
01.01.5105	25	4324251050	EBS2232F	---	EKWA.63.31	EKWA.63.32	---

EBS WABCO AIR DRYERS - 432430 SERIES

EBS Part No	Image	Alternative Part No	Filter	Heater	Repair Kit	Repair Kit	Repair Kit
01.01.6930	26	4324301930	EKWA.63.12	EKWA.63.19	EKWA.63.10	---	---

EBS WABCO AIR DRYERS - 432431 SERIES

EBS Part No	Image	Alternative Part No	Filter	Heater	Repair Kit	Repair Kit	Repair Kit
01.01.6008	27	4324310080	EBS2227F	EKWA.63.19	EKWA.63.9C	EKWA.63.18C	SEKWA.63.9C
01.01.6010	27	4324310100	EBS2227F	EKWA.63.19	EKWA.63.9C	EKWA.63.18C	SEKWA.63.9C

EBS WABCO AIR DRYERS - 432433 SERIES

EBS Part No	Image	Alternative Part No	Filter	Heater	Repair Kit	Repair Kit	Repair Kit
01.01.E062	28	4324330620	EBS2232F	EKWA.63.30	EKWA.63.11	---	---

AIR DRYERS & REPAIR KITS

29



30



EBS WABCO AIR DRYERS - 932400 SERIES

EBS Part No	Image	Alternative Part No	Filter	Heater	Repair Kit	Repair Kit	Repair Kit
*01.01.7024	29	9324000010	EBS2227F	---	EKWA.63.5	EKWA.63.40	EKWA.63.41
*01.01.7024	29	9324000020	EBS2227F	EKWA.63.30	EKWA.63.5	EKWA.63.40	EKWA.63.41
01.01.7003	29	9324000030	EBS2227F	---	EKWA.63.5	EKWA.63.40	EKWA.63.41
01.01.7004	29	9324000040	EBS2227F	---	EKWA.63.5	EKWA.63.40	EKWA.63.41
*01.01.7024	29	9324000050	EBS2227F	---	EKWA.63.5	EKWA.63.40	EKWA.63.41
*01.01.7024	29	9324000060	EBS2227F	EKWA.63.30	EKWA.63.5	EKWA.63.40	EKWA.63.41
01.01.7014	29	9324000140	EBS2227F	EKWA.63.19	EKWA.63.5	EKWA.63.40	EKWA.63.41
01.01.7016	29	9324000160	EBS2232F	EKWA.63.30	EKWA.63.5	EKWA.63.40	EKWA.63.41
01.01.7018	29	9324000180	EBS2282F	EKWA.63.30	EKWA.63.5	EKWA.63.40	EKWA.63.41
*01.01.7024	29	9324000210	EBS2232F	EKWA.63.30	EKWA.63.5	EKWA.63.40	EKWA.63.41
*01.01.7024	29	9324000240	EBS2232F	EKWA.63.30	EKWA.63.5	EKWA.63.40	EKWA.63.41

* This part number superceeds OE numbers.

EBS WABCO Air Processing Units - 932510 Series - For SCANIA

EBS Part No	Image	Alternative Part No	Filter	Heater	Repair Kit	Repair Kit	Repair Kit	Repair Kit
01.01.8956	30	9325109562	EBS2282F	---	EKWA.64.40	EKWA.64.41	EKWA.64.42	---

EBS BENDIX AIR DRYER CARTRIDGES

EBS6968F

Alternative Part No: 286968X50

FOR AD2 AIR DRYERS

EBS7794F

Alternative Part No: 107794

FOR AD9 AIR DRYERS

EKBE.64.9

Alternative Part No: SK2914/1

FOR AD6 AIR DRYERS

EBS HALDEX AIR DRYER CARTRIDGES

EBS1059F

Alternative Part No: 71059

FOR SINGLE 100 & 200 SERIES AIR DRYERS 4 BOLT FIXING

EBS1034F

Alternative Part No: 71034

FOR TWIN 100 & 200 SERIES AIR DRYERS 4 BOLT FIXING

EBS8964F

Alternative Part No: 78964 77430

FOR SINGLE SDX (MTC Version) AIR DRYERS

EBS3522F





Alternative Part No: 93522

FOR SINGLE SDX DRYER WITH COALESCING FILTER







EBS2232F

Alternative Part No: 950310009

FOR ECAM AIR DRYERS

EBS KNORR & WABCO AIR DRYER CARTRIDGES - Conventional				
EBS Part No	Alternative Part No	Information	Image	
EBS1507F	1507434000000	3/4 x 16 UNF Right-hand Thread Height 115mm	Maximum Operating Pressure Of 14 bar For Use On BOSCH ELC Air Dryers	
EBS2227F	272897SP 4324100202 4324102227 II40100F	M39x1.5 Right-hand Thread Standard Height (165mm)	Maximum Operating Pressure Of 13 bar	
EBS2452F	4324102202 II38789F004	M42X1.5 Right-hand Thread Standard Height (165mm)	High Pressure Version Maximum Operating Pressure Of 20 bar	
EBS4525F	1391510 1194525SP II39737F II41300F	M41x1.5 Right-hand Thread Reduced Height (135mm)	Maximum Operating Pressure Of 14 bar	
EBS9272F	1455523 4324102262 4324109262 4324109272	G 1 1/4" Right-hand Thread Height (178mm) - Including Nut	Maximum Operating Pressure Of 13 bar	

EBS KNORR-BREMSE DESICCANT CARTRIDGE			
EBS Part No	Alternative Part No	Information	Image
EBS6837F	K096837K50 21412848	DESICCANT FILTER KIT	
EKKB.68.C	21583789	CARTRIDGE COVER	
EBS7624F	K127624K50	DESICCANT FILTER +HOUSING KIT	

EBS KNORR & WABCO AIR DRYER CARTRIDGES - Oil Separator (OSC)					
EBS Part No	Alternative Part No	Information	Image		
EBS2196F	K102196	41mm x 2mm Thread	Maximum Operating Pressure of 14 bar		
EBS2207F	1523992R 4324152207 5001843522	G 1 1/4" Right-hand Thread Standard Height (165mm)	Maximum Operating Pressure of 13 bar		
EBS2232F	4329012232 950310009	K009460 K039454N50	M39x1.5 Right-hand Thread Standard Height (165mm)	Maximum Operating Pressure of 13 bar	
EBS2262F	4329012452 K005686 K010243	K014712 K039453N50	M39x1.5 Left-hand Thread Standard Height (165mm)	Maximum Operating Pressure of 13 bar	
EBS2282F	4324102262 4324109282 4329012282	G 1 1/4" Right-hand Thread Height (178mm) - Including Nut	Maximum Operating Pressure of 13 bar		
EBS2442F	4324102442	M39x1.5 Right-hand Thread Standard Height (165mm)	Maximum Operating Pressure of 13 bar		

AIR DRYERS & REPAIR KITS

EBS KNORR & WABCO AIR DRYER CARTRIDGES - Oil Separator (OSC)

EBS Part No	Alternative Part No	Information	Image
EBS6383F	1925363 K096383	M39x1.5 Right-hand Thread Height (178mm) - Including Nut Maximum Operating Pressure Of 13 bar	
EBS9455F	4329012462 K010732 K015857 K039455N50	M41x1.5 Right-hand Thread Standard Height (165mm) Maximum Operating Pressure Of 13 bar	

EBS WABCO AIR DRYER CARTRIDGE KITS

EBS Part No	Alternative Part No	Information	Image
EKWA.63	4324069202	INSERT CARTRIDGE REPAIR KIT FOR WABCO 4324062222 CARTRIDGE TO FIT 432405 / 406 / 408 AIR DRYERS	
EKWA.63.12	4324052242 4324062222	AIR DRYER CARTRIDGE REPAIR KIT FOR WABCO 432430 RANGE	

EBS BOSCH ALCOHOL INJECTORS

EBS Part No	Alternative Part No	Repair Kit	Image
01.04.1000	0484451005	EKBO.14	
01.04.1002	0484451006	EKBO.14	
01.04.1003	0484451007	EKBO.14	
01.04.1004	0484451008	EKBO.14	
01.04.1005	0484451009	EKBO.14	
01.04.1006	0484451013	EKBO.14	

EBS CONSEP CONDENSERS

EBS Part No	Alternative Part No	Repair Kit	Image
01.03.3004	92939S	EKGH.65.1	
01.03.3001	92573S	EKGH.65.1	
01.03.3002	92671S	EKGH.65.1	
01.03.3003	92693S	EKGH.65.1	
01.03.3000	92695S	EKGH.65.1	
01.03.3005	91790S	EKGH.65.1	
01.03.3006	92797S	EKGH.65.1	
01.03.3007	92793S	EKGH.65.1	
01.03.3008	92796	EKGH.65.1	

EBS KNORR ALCOHOL INJECTORS

EBS Part No	Alternative Part No	Repair Kit	Image
---	LA4128 LA4129 LA4130 LA4135	EKKB.14.1	

EBS WABCO ALCOHOL INJECTORS

EBS Part No	Alternative Part No	Repair Kit	Image
---	9320020000 9320021000 9320021010 9320021020	EKWA.14.1	

EBS AUTOMATIC DRAIN VALVES			
EBS Part No	Alternative Part No	Repair Kit	Image
01.03.6001	315016001	---	

EBS AUTOMATIC DRAIN VALVES			
EBS Part No	Alternative Part No	Repair Kit	Image
01.06.0001	KX2068/1	---	
01.06.0002	KX2068/2	---	
01.06.0005	KX2068/5	---	
01.06.0007	KX2068/7	---	
01.06.0008	KX2068/8	---	

EBS DRAIN VALVES & FILTER DRAIN VALVES			
EBS Part No	Alternative Part No	Repair Kit	Image
01.01.B000	9343000010 KW2350/1 KW2350/2	---	 22MM
01.01.B001	9343000030	---	 22MM
01.01.B002	9343000070	---	 1/2" - 14 PTF
01.01.9000	4325110000	EKWA.14.6	
01.01.A001	4343000000	EKWA14.3	
01.02.8106	EE4106	EKKB.14.3	
01.02.8115	EE4115	EKKB.14.3	

EBS LINE FILTERS			
EBS Part No	Alternative Part No	Repair Kit	Image
22.01.1020	4325000200 310005011 LA2103	---	

AIR DRYERS & REPAIR KITS

EBS BOSCH AIR DRYER HEATER ELEMENTS & KITS

EKBO.63.23

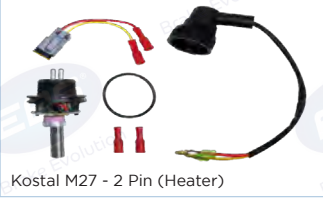

Kostal M27 - 2 Pin (Heater)

EBS KNORR AIR DRYER HEATER ELEMENTS & KITS

EKKB.63.7



Kostal M27 - 2 Pin (Heater)

EKKB.63.19



Volvo Style - 2 Pin

EKKB.63.23

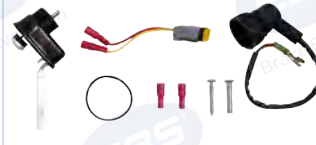

Kostal - M27 - 2 Pin + Deutsch

EKKB.63.24



Bayonet - 2 Pin

EKKB.63.77



Bayonet - 3 Pin

EKKB.63.78



Bayonet - 2 Pin

EKKB.63.79



Kostal - M27 - 2 Pin - 12 Volt

EKKB.63.80



Kostal - M27 - 3 Pin

EKKB.63.81



Bayonet - 2 Pin

Alternative

K107293K50

EBS WABCO AIR DRYER HEATER ELEMENTS & KITS

<p>EKWA.63.7</p>  <p>Kostal - M27 - 2 Pin</p>	<p>EKWA.63.8A</p>  <p>Conversion Cable</p>	<p>EKWA.63.14</p>  <p>Bayonet (DIN72585) - 2 Pin</p>	<p>EKWA.63.19</p>  <p>D Plug - 2 Pin</p>
<p>EKWA.63.23</p>  <p>Kostal - M27 - 2 Pin (Heater)</p>	<p>EKWA.63.30</p>  <p>Bayonet - 24 Vol- 2 Pin</p>	<p>EKWA.63.42</p>  <p>Kostal - M27 - 12 Volt - 2 Pin</p>	<p>EKWA.63.37</p>  <p>Bayonet - 12 Vol- 2 Pin</p>

EBS BENDIX REPAIR KITS

<p>EKBE.62</p> 	<p>EKBE.64</p> 	<p>EKBE.64.9A</p> 	<p>EKBE.64.9B</p> 
<p>EKBE.64.10</p> 	<p>EKBE.64.11</p> 		

EBS BOSCH REPAIR KITS

<p>EKBO.14</p> 	<p>EKBO.63</p> 	<p>EKBO.63.1</p> 	<p>EKBO.63.4</p> 
--	--	---	--

AIR DRYERS & REPAIR KITS

EBS HALDEX REPAIR KITS

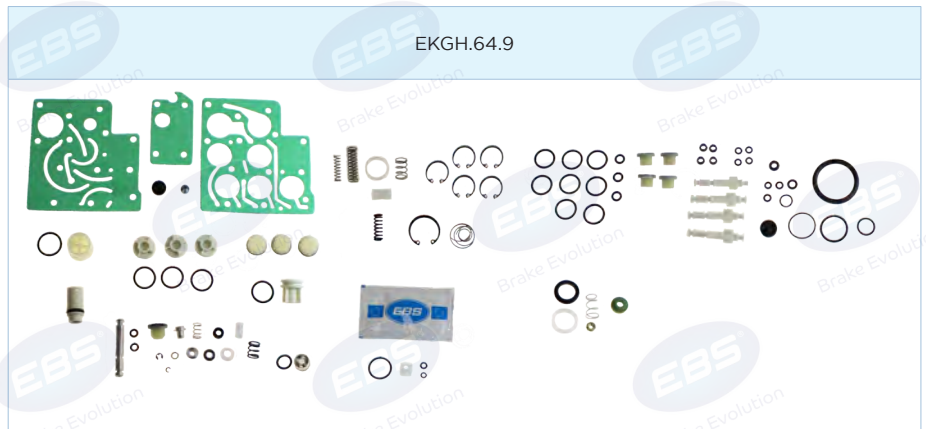

EBS HALDEX CONSEP CONDENSER REPAIR KITS



EBS KNORR BREMSE REPAIR KITS

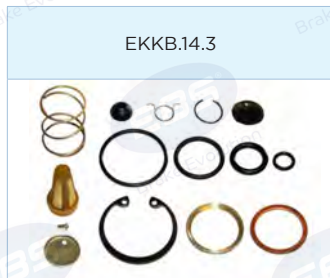

EBS WABCO REPAIR KITS

<p>EKWA.14.1</p> 	<p>EKWA.14.3</p> 	<p>EKWA.14.6</p> 	<p>EKWA.63.1</p> 
<p>EKWA.63.4</p> 	<p>EKWA.63.5</p> 	<p>SEKWA.63.9C</p> 	
<p>EKWA.63.9C</p> 	<p>EKWA.63.11</p> 		
<p>EKWA.63.12</p> 	<p>EKWA.63.18C</p> 	<p>EKWA.63.20</p> 	<p>EKWA.63.24</p> 
<p>EKWA.63.31</p> 	<p>EKWA.63.32</p> 	<p>EKWA.63.40</p> 	<p>EKWA.63.41</p> 
<p>EKWA.63.45</p> 	<p>EKWA.63.45C</p> 	<p>EKWA.63.52</p> 	<p>EKWA.10001</p> 

AIR DRYERS & REPAIR KITS

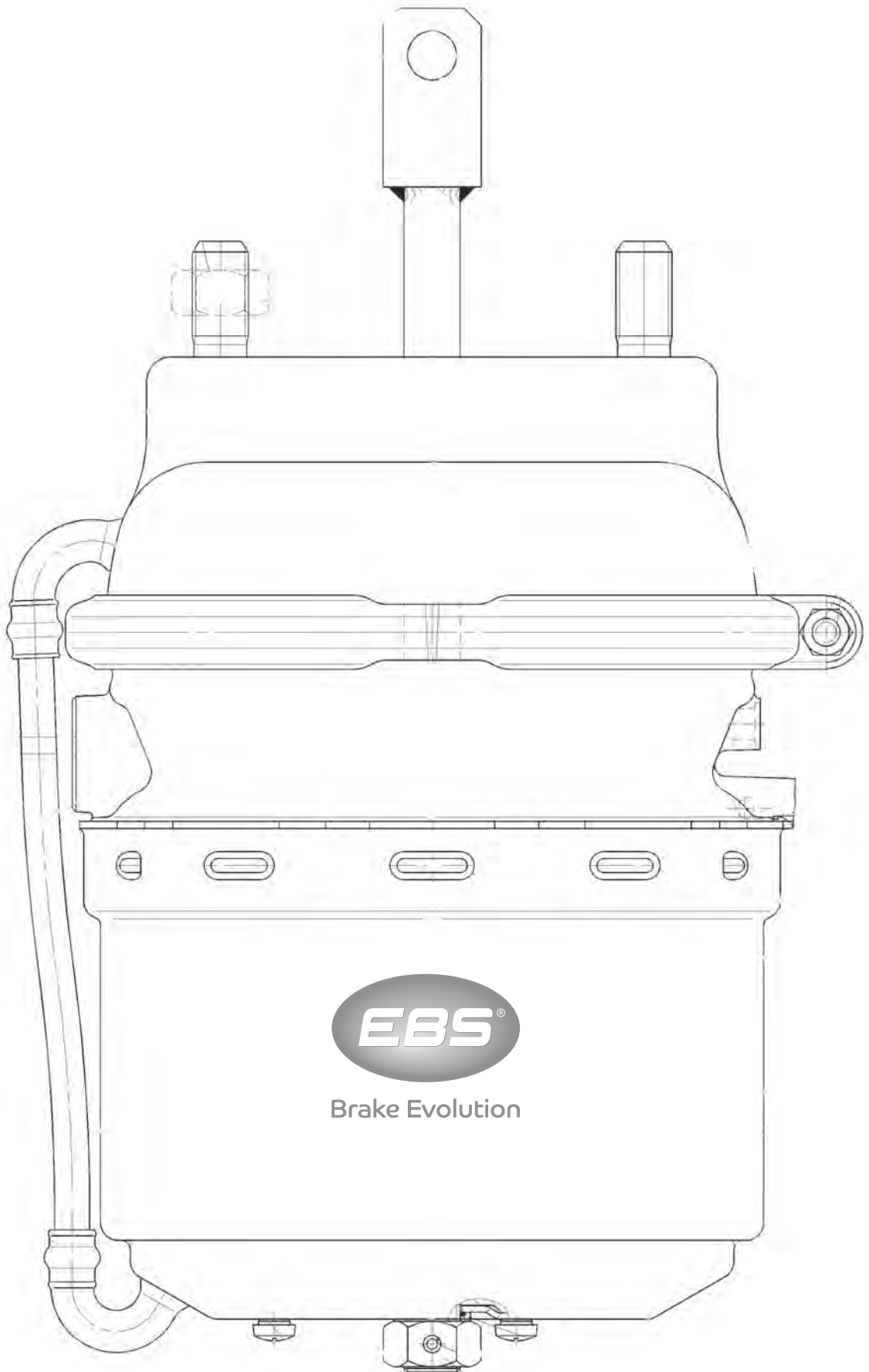

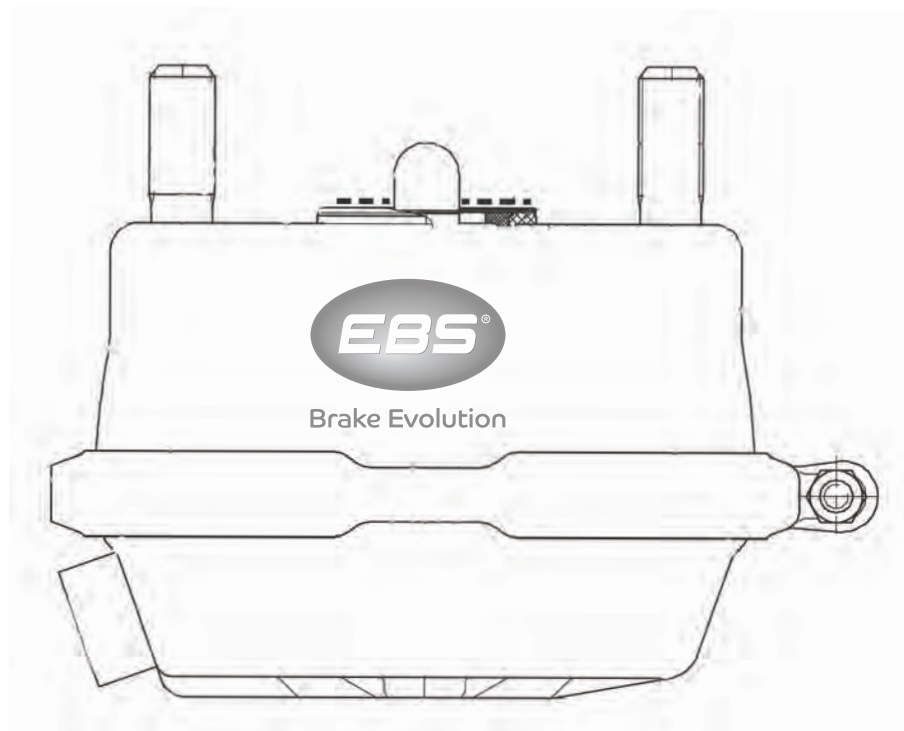
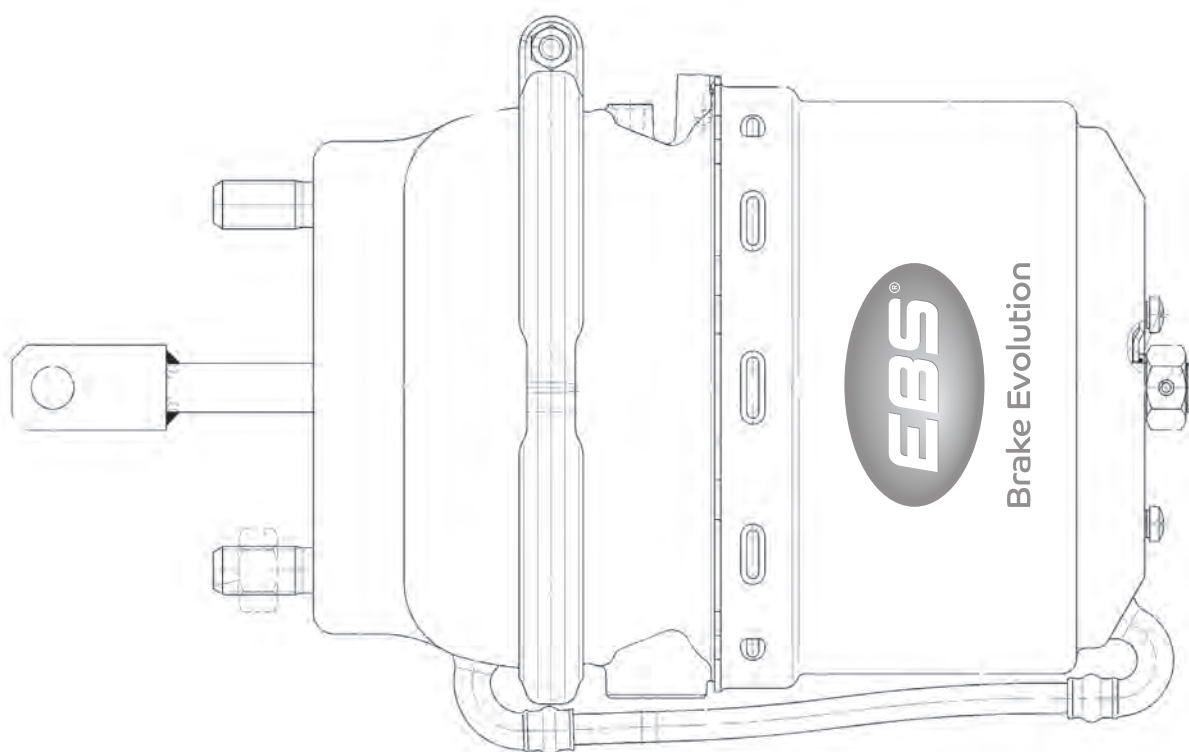

For Brake Chamber Repair Kits see end of section 2

EBS Double Diaphragm Brake Chambers - BPW Disc Brakes

EBS Part No	Alternative Part No	Type	Image
02.1424.BPW	05.444.38.01.0 05.444.38.02.0	14/24	
02.1524.BPW	05.444.39.01.0 05.444.39.02.0	15/24	
02.06.1624.309	BS7309 05.444.40.01.0 05.444.40.02.0	16/24	
02.1824.BPW	05.444.42.01.0 05.444.42.02.0	18/24	
02.2024.BPW	05.444.43.02.0 05.444.43.02.0	20/24	
02.2424.BPW	05.444.46.01.0 05.444.46.02.0	24/24	
02.2430.BPW	---	24/30	

EBS MERITOR Double Diaphragm Type Brake Chambers - Disc Brakes

EBS Part No	Alternative Part No	Type
02.10.6800	41226800	16/16
02.10.6801	41226801	
02.10.6802	41226802	16/24
02.10.6803	41226803	18/24
02.10.6806	41226806	
02.10.6807	41226807	20/24
02.10.6810	41226810	
02.10.6811	41226811	24/30
02.10.6821	41226821	
02.10.7566	41227566	14/24
02.10.7567	41227567	
02.10.7568	41227568	16/24
02.10.7569	41227569	
02.10.7570	41227570	18/24
02.10.7571	41227571	
02.10.7590	41227590	24/24
02.10.7591	41227591	
02.10.9054	41229054	14/24
02.10.9055	41229055	
02.10.9058	41229058	16/24
02.10.9059	41229059	
02.10.6810	41229066	20/24
02.10.6811	41229067	
02.10.9267	41229267	22/24
02.10.9268	41229268	
02.10.9271	41229271	24/24
02.10.9272	41229272	

EBS BPW Single Diaphragm Brake C. Roller Type

EBS Part No	Alternative Part No	Type	Image
02.36.BPW	05.444.10.37.0	36	
02.44.BPW	05.444.10.38.0	44	

EBS Spring Brake Chambers - BPW Disc Brakes

EBS Part No	Alternative Part No	Type	Hand	Image
02.20.1616.03	05.444.41.03.0	16/16	Right	
02.20.1616.04	05.444.41.04.0	16/16	Left	
02.20.1624.07	05.444.40.07.3	16/24	Right	
02.20.1624.08	05.444.40.08.3	16/24	Left	
02.20.2024.01	05.444.44.01.0	20/24	Right	
02.20.2024.02	05.444.44.02.0	20/24	Left	



EBS BPW Locking Chambers

EBS Part No	Alternative Part No	Type	Image
02.20.12.00	02.0327.38.00	38	

EBS MERITOR Double Diaphragm Brake Chambers - ROR Disc Brakes

EBS Part No	Alternative Part No	Type	Image
02.10.5763	41225763	24/24	
02.10.5764	41225764	22/24	
02.10.5765	41225765	20/24	
02.10.5766	41225766	18/24	
02.2024.ROR	41231055	20/24	

EBS MERITOR - Locking Chambers

EBS Part No	Alternative Part No	Type	Image
02.36.09.100	21212472	9 CHAMFERED BLOCK	
02.36.09.101	21223339	9 SQUARE BLOCK	



EBS MERITOR Single Diaphragm Brake Chambers - ROR Brakes

EBS Part No	Alternative Part No	Type	Image
02.10.5486	68325486	20	
02.10.5487	68325486	20	
02.10.5767	41225767	24	

EBS MERITOR Single Diaphragm Brake Chambers - Disc Brakes			
EBS Part No	Alternative Part No	Type	Image
02.10.5960	68325960		
02.10.5961	68325961	20	
02.10.7562	41227562	14	
02.10.7563	41227563	14	
02.10.7564	41227564	16	
02.10.7565	41227565	16	
02.10.7865	41227865	18	
02.10.7866	41227866	18	
02.10.9060	41229060	18	
02.10.9064	41229064	20	
02.10.9065	41229065	20	

EBS Double Diaphragm Spring Brake Chambers - Cam Brakes			
EBS Part No	Alternative Part No	Type	Type
NK012501	K012501	24/30	75
NK012502	K012502	24/30	75

EBS Double Diaphragm Spring Brake Chambers - Cam Brakes			
EBS Part No	Alternative Part No	Type	Stroke
02.2030.75	9253751000	20/30	75
02.01.2430.75	9253761010	24/30	75
---	9253761220	24/30	75
02.3030.1000	9253771000	30/30	75

EBS Double Diaphragm Brake Chambers- SAF Disc Brakes			
EBS Part No	Alternative Part No	Type	Image
02.24.7464	4454107464	18/24	
02.24.7764	4454107764	16/24	
02.24.7964	4454107964	20/24	
JYE.011	9253840502	Pipe Kit 1 x Kit Will Make Any Of The Versions Pictured	 <p>Unequal Legs Equal Legs Off-Set Legs</p>
EBS.012	9253840502	SAF Conversion Kit for 02.06.1624.309	



EBS HALDEX Single Diaphragm Brake Chambers - Cam Brake			
EBS Part No	Alternative Part No	Type	Type
02.13.1000	120927303	27	Metric

EBS HALDEX Single Diaphragm Brake Chambers - Disc Brake			
EBS Part No	Alternative Part No	Type	Type
02.13.1003	125240405	24	Metric
02.13.1004	125240406	24	Metric

EBS Double Diaphragm Brake Chambers - Cam Brakes			
EBS Part No	Type	Stroke	Image
02.1624.57	16/24	57	
02.2024.64	20/24	64	
02.2424.64	24/24	64	
02.2430.64	24/30	64	
02.2430.75	24/30	75	
02.3030.64	30/30	64	
02.3030.75	30/30	75	

EBS HALDEX Dual Diaphragm Brake Chambers - Cam Brake				
EBS Part No	Alternative Part No	Type	Type	Image
02.13.1001	121150003	24	Metric	
02.13.1002	121254003	24	Imperial	

BRAKE CHAMBERS & REPAIR KITS

Rationalised EBS Single Diaphragm Brake Chambers - Cam Brakes

EBS Part No	Type	Stroke	Image
02.01.09.900	9	75	
02.01.12.900	12	75	
02.01.16.900	16	75	
02.01.20.900	20	75	
02.01.24.900	24	75	
02.01.30.900	30	75	
02.01.36.900	36	75	

EBS BENDIX Single Diaphragm Brake Chambers - Cam Brakes

Bendix Part No	EBS Part No	Type	Repair Kit
1189470	02.14.9470	14	---
1186699-01	02.14.6699	16	---
274421	02.14.1000	16	---
1186883-08	02.14.6883	20	---
274422	02.14.1001	20	---
295554	02.14.1004	20	---
1188782-01	02.14.8782	24	---
274423	02.14.1002	24	---
295555	02.14.1005	24	---
1194122	02.14.4122	27	---
1194138	02.14.4138	27	---
1188783	02.14.8783	30	---
274424	02.14.1003	30	---
295556	02.14.1006	30	---

Rationalised EBS Single Diaphragm Brake Chambers - Disc Brakes

EBS Part No	Type	Stroke	Image
02.06.1457	14	57	
02.06.1464	14	64	
02.06.1564	15	64	
02.06.1657	16	57	
02.06.1664	16	64	
02.06.1864	18	64	
02.06.2057	20	57	
02.06.2064	20	64	
02.06.2075	20	75	
02.06.2264	22	64	
02.06.2457	24	57	
02.06.2464	24	64	
02.06.2475	24	75	
02.06.3057	30	57	
02.06.3064	30	64	



EBS BENDIX Single Diaphragm Brake Chambers - Cam Brakes

Rationalised EBS Single Diaphragm Brake Chambers - Disc Brakes - Yoke Type

EBS Part No	Type	Image
02.01.20.111	20	
02.01.24.106	24	

EBS KNORR Single Diaphragm Brake Chambers - Cam Brakes

Knorr Part No	EBS Part No	Type	Repair Kit
BZ3353	02.01.16.353	16	---
BZ3490	02.01.20.490	20	---
BZ3491	02.01.20.491	20	---
BX3527	02.01.24.527	24	---
BX3550	02.01.27.550	27	---
BX3556	02.01.24.556	24	---
BZ3589	02.01.24.3589	24	---
BZ3593	02.01.24.3593	24	---
BZ3598	02.01.27.598	27	---
BZ3599	02.01.27.599	27	---

EBS WABCO Single Diaphragm Brake Chambers - Cam Brakes

Wabco Part No	EBS Part No	Type	Repair Kit
4231020150	02.01.09.015	9	---
4230070190	02.01.30.019	30	---
4230089170	02.01.36.917	36	---
4231040020	02.01.16.002	16	---
4231040040	02.01.16.004	16	---
4231040100	02.01.16.010	16	---
4231040930	02.01.16.093	16	---
4231046060	02.01.16.606	16	---
4231046080	02.01.16.608	16	---
4231050040	02.01.20.004	20	---
4231050300	02.01.20.030	20	---
4231050310	02.01.20.031	20	---
4231050720	02.01.20.072	20	---
4231050800	02.01.20.080	20	---
4231050840	02.01.20.084	20	---
4231050890	02.01.20.089	20	---
4231050980	02.01.20.098	20	---
4231051110	02.01.20.111	20	---
4231051250	02.01.20.125	20	---
4231051260	02.01.20.126	20	---
4231051340	02.01.20.134	20	---
4231051990	02.01.20.199	20	---
4231052920	02.01.20.920	20	---
4231054060	02.01.20.406	20	---
4231054080	02.01.20.408	20	---
4231054090	02.01.20.409	20	---
4231054170	02.01.20.417	20	---
4231054500	02.01.20.450	20	---
4231054510	02.01.20.451	20	---
4231057040	02.01.20.704	20	---
4231060410	02.01.24.041	24	---
4231060460	02.01.24.046	24	---
4231060580	02.01.24.058	24	---
4231060810	02.01.24.081	24	---
4231060880	02.01.24.088	24	---
4231060950	02.01.24.095	24	---
4231060960	02.01.24.096	24	---
4231060980	02.01.24.098	24	---
4231061060	02.01.24.106	24	---
4231061150	02.01.24.115	24	---
4231061250	02.01.24.125	24	---
4231061440	02.01.24.144	24	---
4231062010	02.01.24.201	24	---
4231062020	02.01.24.202	24	---
4231062070	02.01.24.207	24	---
4231062080	02.01.24.208	24	---

EBS WABCO Single Diaphragm Brake Chambers - Cam Brakes

Wabco Part No	EBS Part No	Type	Repair Kit
4231062920	02.01.24.292	24	---
4231062940	02.01.24.294	24	---
4231062950	02.01.24.295	24	---
4231064020	02.01.24.402	24	---
4231064030	02.01.24.403	24	---
4231064080	02.01.24.408	24	---
4231064090	02.01.24.409	24	---
4231064210	02.01.24.421	24	---
4231064230	02.01.24.423	24	---
4231064300	02.01.24.430	24	---
4231064500	02.01.24.450	24	---
4231070080	02.01.30.008	30	---
4231070980	02.01.30.098	30	---
4231074060	02.01.30.406	30	---
4231074070	02.01.30.407	30	---
4231074080	02.01.30.408	30	---
4231074110	02.01.30.411	30	---
4231090010	02.01.27.001	27	---
4231090030	02.01.27.003	27	---
4231090040	02.01.27.004	27	---
4231090070	02.01.27.007	27	---
4231090080	02.01.27.008	27	---
4231090100	02.01.27.010	27	---
4231090130	02.01.27.013	27	---
4231090200	02.01.27.020	27	---
4231090220	02.01.27.022	27	---
4231091020	02.01.27.102	27	---
4231091200	02.01.27.120	27	---
4231099000	02.01.27.900	27	---
4231100010	02.01.22.001	22	---
4231140020	02.01.14.002	14	---
4231140100	02.01.14.010	14	---
4232061010	02.01.24.101	24	---



EBS WABCO Single Diaphragm Brake Chambers - Cam Brakes

BRAKE CHAMBERS & REPAIR KITS

**EBS KNORR Single Diaphragm
Brake Chambers - Disc Brakes**

Knorr Part No	EBS Part No	Type	Repair Kit
BS2402	02.06.20.2402	20	---
BS2403	02.06.20.2403	20	---
BS2406	02.06.20.2406	20	---
BS2407	02.06.20.2407	20	---
BS2408	02.06.20.2408	20	---
BS2503	02.06.24.503	24	---
BS2504	02.06.24.504	24	---
BS2505	02.06.24.505	24	---
BS2514	02.06.24.2514	24	---
BS2515	02.06.24.2515	24	---
BS2523	02.06.24.2523	24	---
BS2524	02.06.24.2524	24	---
BS2546	02.06.24.546	24	---
BS3152	02.06.10.152	10	---
BS3155	02.06.10.155	10	---
BS3201	02.06.12.201	12	---
BS3207	02.06.12.207	12	---
BS3212	02.06.12.212	12	---
BS3213	02.06.12.213	12	---
BS3215	02.06.12.215	12	---
BS3250	02.06.14.250	14	---
BS3261	02.06.14.261	14	---
BS3269	02.06.14.269	14	---
BS3273	02.06.14.273	14	---
BS3281	02.06.14.281	14	---
BS3300	02.06.16.300	16	---
BS3301	02.06.16.301	16	---
BS3316	02.06.16.316	16	---
BS3317	02.06.16.317	16	---
BS3324	02.06.16.324	16	---
BS3326	02.06.16.326	16	---
BS3325	02.06.16.325	16	---
BS3332	02.06.16.332	16	---
BS3335	02.06.16.335	16	---
BS3336	02.06.16.336	16	---
BS3337	02.06.16.337	16	---
BS3350	02.06.18.335	18	---
BS3363	02.06.18.363	18	---
BS3364	02.06.18.364	18	---
BS3368	02.06.18.368	18	---
BS3369	02.06.18.369	20	---
BS3401	02.06.20.401	20	---
BS3402	02.06.20.402	20	---
BS3403	02.06.20.403	20	---
BS3404	02.06.20.404	20	---
BS3410	02.06.20.410	20	---

**EBS KNORR Single Diaphragm
Brake Chambers - Disc Brakes**

Knorr Part No	EBS Part No	Type	Repair Kit
BS3411	02.06.20.411	20	---
BS3412	02.06.20.412	20	---
BS3413	02.06.20.413	20	---
BS3414	02.06.20.414	20	---
BS3415	02.06.20.415	20	---
BS3423	02.06.20.423	20	---
BS3433	02.06.20.433	20	---
BS3434	02.06.20.434	20	---
BS3435	02.06.20.435	20	---
BS3451	02.06.22.451	22	---
BS3452	02.06.22.452	22	---
BS3458	02.06.22.458	22	---
BS3467	02.06.22.467	22	---
BS3471	02.06.22.471	22	---
BS3472	02.06.22.472	22	---
BS3474	02.06.22.474	22	---
BS3475	02.06.22.475	22	---
BS3501	02.06.24.501	24	---
BS3508	02.06.24.508	24	---
BS3509	02.06.24.509	24	---

**EBS KNORR Single Diaphragm
Brake Chambers - Disc Brakes**

Knorr Part No	EBS Part No	Type	Repair Kit
BS3514	02.06.24.3514	24	---
BS3515	02.06.24.3515	24	---
BS3516	02.06.24.3516	24	---
BS3520	02.06.24.520	24	---
BS3521	02.06.24.521	24	---
BS3522	02.06.24.522	24	---
BS3526	02.06.24.526	24	---
BS3528	02.06.24.528	24	---
BS3532	02.06.24.532	24	---
BS3536	02.06.24.536	24	---
BS3537	02.06.24.537	24	---
BS3603	02.06.30.603	30	---
BS3605	02.06.30.605	30	---
BS3800	02.06.20.800	20	---
BS3801	02.06.20.801	20	---
BS3409	02.06.20.409	20	---

EBS KNORR & WABCO
Single Diaphragm
Brake Chambers - Disc Brakes



EBS WABCO Single Diaphragm Brake Chambers - Disc Brakes

Wabco Part No	EBS Part No	Type	Repair Kit
4231047000	02.06.16.700	16	---
4231047100	02.06.16.710	16	---
4231047110	02.06.16.711	16	---
4231047120	02.06.16.712	16	---
4231050200	02.06.20.020	20	---
4231057000	02.06.20.700	20	---
4231067000	02.06.24.700	24	---
4231067010	02.06.24.701	24	---
4231107100	02.06.22.710	22	---
4231107110	02.06.22.711	22	---
4232051010	02.01.20.101	20	---
4235030000	02.06.12.000	12	---
4235030110	02.06.12.011	12	---
4235040020	02.06.16.002	16	---
4235040120	02.06.16.012	16	---
4235040130	02.06.16.013	16	---
4235040140	02.06.16.014	16	---
4235040200	02.06.16.020	16	---
4235040210	02.06.16.021	16	---
4235040240	02.06.16.024	16	---
4235041100	02.06.16.110	16	---
4235050010	02.06.20.001	20	---
4235050020	02.06.20.002	20	---
4235050070	02.06.20.007	20	---
4235060010	02.06.24.001	24	---
4235060030	02.06.24.003	24	---
4235060200	02.06.24.020	24	---
4235060210	02.06.24.021	24	---
4235060240	02.06.24.024	24	---
4235060250	02.06.24.025	24	---
4235060430	02.06.24.043	24	---
4235060600	02.06.24.060	24	---
4235041300	02.06.16.130	16	---
4235060500	02.06.24.050	24	---
4235060510	02.06.24.051	24	---
4235060520	02.06.24.052	24	---
4235060530	02.06.24.053	24	---
4235060550	02.06.24.055	24	---
4235060720	02.06.24.072	24	---
4235060810	02.06.24.081	24	---
4235061000	02.06.24.100	24	---
4235061010	02.06.24.101	24	---
4235061020	02.06.24.102	24	---
4235061030	02.06.24.103	24	---
4235061040	02.06.24.104	24	---

EBS WABCO Single Diaphragm Brake Chambers - Disc Brakes

Wabco Part No	EBS Part No	Type	Repair Kit
4235061200	02.06.24.200	24	---
4235061230	02.06.24.123	24	---
4235061240	02.06.24.124	24	---
4235061300	02.06.24.130	24	---
4235061430	02.06.24.143	24	---
4235090200	02.06.27.020	27	---
4235100100	02.06.22.010	22	---
4235100200	02.06.22.020	22	---
4235100210	02.06.22.021	22	---
4235110100	02.06.25.010	25	---
4235110110	02.06.25.011	25	---
4235120100	02.06.18.010	18	---
4235140200	02.06.14.020	14	---
4231074110	02.06.30.411	30	---

Rationalised EBS WABCO F Type Spring Brake Chambers - Cam Brakes

EBS Part No	Type	Repair Kit
N8901103570	16/16	---
N8901103470	16/24	EKWA.48.1
N8901103280	20/20	---
N8901103480	20/24	EKWA.48.1
N8901103490	20/30	EKWA.47.1
N8901103500	24/24	EKWA.48.1
N8901103510	24/30	EKWA.47.1
N8901103600	27/24	EKWA.48.1
N8901103690	27/30	EKWA.47.1
N8901103520	30/24	EKWA.48.1
N8901103530	30/30	EKWA.47.1
N8901103540	36/30	EKWA.47.1
N8901103700	12/12	---



BRAKE CHAMBERS & REPAIR KITS

EBS F Type Spring Brake Chambers - Cam Brakes - MAN Application

EBS Part No	Alt. Part No	Type	Repair Kit
02.01.1212.118	03.10.00.27	12/12	EKWA.49



Rationalised EBS G Type Spring Brake Chambers - Disc Brakes

STANDARD Spring - 22mm VOSS Ports		
EBS Part No	Type	Repair Kit
02.06.1016.22.0	10/16	---
02.06.1216.22.0	12/16	---
02.06.1224.22.0	12/24	---
02.06.1416.22.0	14/16	---
02.06.1424.22.0	14/24	---
02.06.1616.22.0	16/16	---
02.06.1624.22.0	16/24	---
02.06.2024.22.0	20/24	---
02.06.2030.22.0	20/30	---
02.06.2424.23.0	24/24	---
02.06.2430.22.0	24/30	---

Please Note: Ports are in line with the studs



Rationalised EBS WABCO F Type Spring Brake Chambers - Disc Brakes

EBS Part No	Type	Repair Kit
02.06.1624.304	16/24	EKWA.48.1
02.06.2024.404	20/24	EKWA.48.1
02.06.2424.503	24/24	EKWA.48.1

Rationalised EBS G Type Spring Brake Chambers - Cam Brakes

22mm VOSS Ports c/w 16mm Reducer		
EBS Part No	Type	Repair Kit
02.01.1624.22.0	16/24	---
02.01.2024.22.0	20/24	---
02.01.2424.22.0	24/24	---
02.01.2430.22.0	24/30	---
02.01.2724.22.0	27/24	---
02.01.2730.22.0	27/30	---
02.01.3030.22.0	30/30	---

Please Note: Ports are in line with the studs 300mm Push Road Length

Rationalised EBS G Type Spring Brake Chambers Cam Brakes
02.01.2024.22.0



Rationalised EBS G Type Spring Brake Chambers Disc Brakes
02.06.2024.1W

Rationalised EBS G Type Spring Brake Chambers - Disc Brakes

HIGH FORCE Spring - 22mm VOSS Ports		
EBS Part No	Type	Repair Kit
02.06.1624.22.OHF3	16/24	---
02.06.2024.22.OHF3	20/24	---
02.06.2424.22.OHF3	24/24	---

Please Note: Ports are in line with the studs



Rationalised EBS G Type Spring Brake Chambers - Disc Brakes

STANDARD Spring- Internal Wind Off Bolt- 22mm VOSS Ports		
EBS Part No	Type	Repair Kit
02.06.1624.1W	16/24	---
02.06.2024.1W	20/24	---
02.06.2424.1W	24/24	---
02.06.2430.1W	24/30	---

Please Note: Ports are in line with the studs

EBS WABCO F Type Spring Brake Chambers - Cam Brakes

Wabco Part No	EBS Part No	Type	Repair Kit
9253200800	02.00.2024.080	20/24	EKWA.48.1
9253204000	02.00.2030.400	20/30	EKWA.47.1
9253205020	02.00.2030.502	20/30	EKWA.47.1
9253205430	02.00.2030.543	20/30	EKWA.47.1
9253205560	02.00.2030.556	20/30	EKWA.47.1
9253211600	02.01.2424.160	24/24	EKWA.48.1
9253214180	02.00.2430.418	24/30	---
9253214240	02.01.2430.424	24/30	---
9253214340	02.01.2430.434	24/30	---
9253220150	---	30/24	EKWA.47.5
9253220250	---	30/24	EKWA.47.5
9253220810	02.01.3030.081	30/30	---
9253221020	---	30/30	EKWA.47.5
9253224240	02.00.3030.424	30/30	---
9253222050	02.00.3030.205	30/30	EKWA.47.1
9253222150	02.00.3030.215	30/30	EKWA.47.1
9253222410	02.00.3030.241	30/30	EKWA.47.1
9253227010	02.01.3024.701	30/24	EKWA.47.5
9253240000	02.00.1624.000	16/24	EKWA.48.1
9253240290	02.01.1624.029	16/24	---
9253241030	02.00.1624.103	16/24	EKWA.48.1
9253251180	02.01.1212.118	12/12	---
9254941060	02.01.1624.106	16/24	---
9253252160	02.00.1216.216	12/16	---
9254207010	02.00.2024.701	20/24	EKWA.48.1G
9254209030	02.00.2024.903	20/24	---
9254210850	02.00.2424.085	24/24	EKWA.48.1G
9254911510	02.01.2424.151	24/24	---
9254212000	02.01.2424.200	24/24	---
9254212010	02.01.2424.201	24/24	---
9254213420	02.00.2424.342	24/24	---
9254213460	02.00.2424.346	24/24	---
9254271020	02.00.2224.102	22/24	---
9254271000	02.00.2224.100	22/24	EKWA.48.1
9254290020	02.00.2730.002	27/30	EKWA.47.1G
9254922710	02.01.3024.271	30/24	---
9254928610	02.01.3024.861	30/24	EKWA.47.5

EBS WABCO F Type Spring Brake Chambers - Cam Brakes

Wabco Part No	EBS Part No	Type	Repair Kit
9254928710	02.01.3024.871	30/24	EKWA.47.5
9254929010	02.00.2030.901	20/30	EKWA.47.1

EBS KNORR G Type Spring Brake Chambers - Cam Brakes

Knorr Part No	EBS Part No	Type	Repair Kit
1137276	02.01.2030.22.0	20/30	---
BZ7419	02.01.2030.419	20/30	EKKB.38
BZ9331	02.01.1624.331	16/24	---
BZ9524	02.01.2424.524	24/24	---
BZ9425	02.01.2030.425	20/30	---
BZ9529	02.01.2430.529	24/30	---
BZ9553	02.01.2724.553	27/24	---
BZ9554	02.01.2724.554	27/24	---
BZ9424	02.01.2024.424	20/24	---
BZ9447	02.01.2024.447	20/24	---
BZ9630	02.01.3030.630	30/30	---
BZ9631	02.01.3030.631	30/30	---
BZ9687 K153968N00	02.01.3030.687	30/30	---

EBS WABCO G Type Spring Brake Chambers - Cam Brakes

Wabco Part No	EBS Part No	Type	Repair Kit
9253051180	02.01.1212.118	12/12	EKWA.49
9253051300	02.01.1212.130	12/12	EKWA.49
9253051400	---	12/12	EKWA.49
9253290120	02.01.2730.012	27/30	EKWA.47.1G
9253212020	02.01.2424.203	24/24	EKWA.48.1
9253212030	02.01.2424.203	24/24	EKWA.48.1
9253212920	02.01.2424.292	24/24	EKWA.48.1
9253220910	02.01.3030.091	30/30	EKWA.47.1G
9253222500	02.01.3030.250	30/30	EKWA.47.1
9253222510	02.01.3030.251	30/30	EKWA.47.1
9253240400	02.01.1624.040	16/24	EKWA.48.1
9253248010	02.01.1616.801	16/16	---
9253290210	02.01.2730.021	27/30	EKWA.47.1

EBS KNORR G Type Spring Brake Chamber- Cam Brake
02.01.2024.424



EBS WABCO G Type Spring Brake Chamber- Cam Brake
02.01.2424.037



BRAKE CHAMBERS & REPAIR KITS

EBS WABCO G Type Spring Brake Chambers - Cam Brakes			
Wabco Part No	EBS Part No	Type	Repair Kit
9253291210	02.01.2724.121	27/24	EKWA.48.1G
9254201030	02.01.2024.103	20/24	---
9254204060	02.01.2030.406	20/30	EKWA.47.1G
9254205020	02.01.2030.502	20/30	EKWA.47.1G
9254207500	02.01.2024.750	20/24	EKWA.48.1G
9254209010	02.01.2030.901	20/30	EKWA.47.1G
9254209020	02.01.2024.902	20/24	EKWA.48.1G
9254211070	02.01.2424.1070	24/24	EKWA.48.1G
9254211410	02.01.2424.141	24/24	EKWA.48.1G
9254211420	02.01.2424.142	24/24	EKWA.48.1G
9254211440	02.01.2424.144	24/24	EKWA.48.1G
9254211450	02.01.2424.145	24/24	EKWA.48.1G
9254211460	02.01.2424.146	24/24	EKWA.48.1G
9254214520	02.01.2430.452	24/30	EKWA.47.1G
9254214530	02.01.2430.453	24/30	EKWA.47.1G
9254214700	02.01.2430.470	24/30	EKWA.47.1G
9254215000	02.01.2430.500	24/30	EKWA.47.1G
9254215010	02.01.2430.501	24/30	EKWA.47.1G
9254215400	02.01.2430.540	24/30	EKWA.47.1G
9254215510	02.01.2430.5510	24/30	EKWA.47.1G
9254217500	02.01.2424.750	24/24	EKWA.48.1G
9254217510	02.01.2424.751	24/24	EKWA.48.1G
9254217520	02.01.2424.752	24/24	EKWA.48.1G
9254221000	02.01.3030.100	30/30	EKWA.47.1G
9254221020	02.01.3030.1020	30/30	EKWA.47.1G
9254221500	02.01.3030.150	30/30	EKWA.47.1G
9254221510	02.01.3030.151	30/30	EKWA.47.1G
9254221520	02.01.3030.152	30/30	EKWA.47.1G
9254221530	02.01.3030.153	30/30	EKWA.47.1G
9254221560	02.01.3030.156	30/30	EKWA.47.1G
9254221570	02.01.3030.157	30/30	EKWA.47.1G
9254221980	02.01.3030.198	30/30	EKWA.47.1G
9254224230	02.01.3030.423	30/30	EKWA.47.1G
9254224330	02.01.3030.433	30/30	EKWA.47.1G
9254229020	02.01.3030.902	30/30	EKWA.47.1G
9254229100	02.01.3024.910	30/24	EKWA.48.1G
9254241000	02.01.1624.100	16/24	EKWA.48.1G
9254249000	02.01.1616.900	16/16	---
9254261010	02.06.1216.1010	12/16	---
9254270100	02.01.2230.010	22/30	EKWA.47.1G
9254270110	02.01.2230.011	22/30	EKWA.47.1G
9254271100	02.01.2224.110	22/24	EKWA.48.1G
9254271130	02.01.2224.113	22/24	EKWA.48.1G
9254271140	02.01.2224.114	22/24	EKWA.48.1G
9254290500	02.01.2730.050	27/30	EKWA.47.1G
9254290510	02.01.2730.051	27/30	EKWA.47.1G

EBS WABCO G Type Spring Brake Chambers - Cam Brakes			
Wabco Part No	EBS Part No	Type	Repair Kit
9254290610	02.01.2730.061	27/30	EKWA.47.1G
9254290620	02.01.2730.062	27/30	EKWA.47.1G
9254291700	02.01.2724.170	27/24	EKWA.48.1G
9254291760	02.01.2724.176	27/24	EKWA.48.1G
9254291770	02.01.2724.177	27/24	EKWA.48.1G
9254291800	02.01.2724.180	27/24	EKWA.48.1G
9254291850	02.01.2724.185	27/24	EKWA.48.1G
9254291810	02.01.2724.181	27/24	EKWA.48.1G
9254291820	02.01.2724.182	27/24	EKWA.48.1G
9254291840	02.01.2724.184	27/24	EKWA.48.1G
9254291840	02.01.2724.840	27/24	EKWA.48.1G
9254300300	02.01.2024.030	20/24	EKWA.48.1G
9254300350	02.01.2024.035	20/24	EKWA.48.1G
9254300360	02.01.2024.036	20/24	EKWA.48.1G
9254300660	02.01.2024.066	20/24	EKWA.48.1G
9254301430	02.01.2024.143	20/24	EKWA.48.1G
9254301440	02.01.2024.144	20/24	EKWA.48.1G
9254310330	02.01.2424.033	24/24	EKWA.48.1G
9254310340	02.01.2424.034	24/24	EKWA.48.1G
9254310370	02.01.2424.037	24/24	EKWA.48.1G
9254310380	02.01.2424.038	24/24	EKWA.48.1G
9254310630	02.01.2424.063	24/24	EKWA.48.1G
9254310910	02.01.2424.091	24/24	EKWA.48.1G
9254310920	02.01.2424.092	24/24	EKWA.48.1G
9254310940	02.01.2424.094	24/24	EKWA.48.1G
9254310950	02.01.2424.095	24/24	EKWA.48.1G
9254310980	02.01.2424.098	24/24	EKWA.48.1G
9254311400	02.01.2424.140	24/24	EKWA.48.1G
9254311430	02.01.2424.143	24/24	EKWA.48.1G
9254311440	02.01.2424.1440	24/24	EKWA.48.1G
9254311450	02.01.2424.1450	24/24	EKWA.48.1G
9254314210	02.01.2430.421	24/30	EKWA.47.1G
9254314220	02.01.2430.422	24/30	EKWA.47.1G
9254314230	02.01.2430.423	24/30	EKWA.47.1G
9254314830	02.01.2430.483	24/30	EKWA.47.1G
9254314900	02.01.2430.490	24/30	EKWA.47.1G
9254315150	02.01.2430.515	24/30	EKWA.47.1G
9254315500	02.01.2430.550	24/30	EKWA.47.1G
9254315510	02.01.2430.551	24/30	EKWA.47.1G
9254321150	02.01.3030.115	30/30	EKWA.47.1G
9254321170	02.01.3030.117	30/30	EKWA.47.1G
9254321180	02.01.3030.118	30/30	EKWA.47.1G
9254322010	02.01.3030.201	30/30	---
9254324400	02.01.3030.440	30/30	EKWA.47.1G
9254324810	02.01.3030.481	30/30	EKWA.47.1G
9254324820	02.01.3030.482	30/30	EKWA.47.1G

EBS WABCO G Type Spring Brake Chambers - Cam Brakes

Wabco Part No	EBS Part No	Type	Repair Kit
9254324830	02.01.3030.483	30/30	EKWA.47.1G
9254324840	02.01.3030.484	30/30	EKWA.47.1G
9254324850	02.01.3030.485	30/30	EKWA.47.1G
9254324860	02.01.3030.486	30/30	EKWA.47.1G
9254324870	02.01.3030.487	30/30	EKWA.47.1G
9254329280	R02.01.3030.928	30/30	EKWA.47.1G
9254391100	02.01.2724.110	27/24	EKWA.48.1G
9254394050	02.01.2730.405	27/30	EKWA.47.1G
9254394060	02.01.2730.406	27/30	EKWA.47.1G
9254901010	02.01.2030.101	20/30	---
9254901020	02.01.2024.102	20/24	---
9254901070	02.01.2024.107	20/24	---
9254907550	02.01.2024.755	20/24	---
9254909050	02.01.2024.905	20/24	---
9254909060	02.01.2030.906	20/30	---
9254910300	02.01.2424.030	24/24	---
9254910310	02.01.2424.031	24/24	---
9254910320	02.01.2424.032	24/24	---
9254911030	02.01.2424.103	24/24	---
9254911040	02.01.2424.104	24/24	---
9254911050	02.01.2424.105	24/24	---
9254911060	02.01.2424.106	24/24	---
9254911070	02.01.2424.107	24/24	---
9254911080	02.01.2424.108	24/24	---
9254911100	02.01.2424.110	24/24	---
9254911110	02.01.2430.111	24/30	---
9254911150	02.01.2424.115	24/24	---
9254911160	02.01.2424.116	24/24	---
9254911170	02.01.2424.117	24/24	---
9254911180	02.01.2424.118	24/24	EKWA.48.1G
9254911220	02.01.2424.122	24/24	---
9254911230	02.01.2424.123	24/24	---
9254911240	02.01.2424.124	24/24	---
9254911300	02.01.2430.130	24/30	---
9254911310	02.01.2430.131	24/30	---
9254911320	02.01.2430.132	24/30	---
9254911330	02.01.2430.133	24/30	---
9254911340	02.01.2430.134	24/30	---
9254911350	02.01.2430.135	24/30	---
9254911410	N9254911410	24/24	EKWA.48.1G
9254911430	02.01.2430.143	24/30	---
9254914300	02.01.2430.430	24/30	---
9254914330	02.01.2430.433	24/30	---
9254914400	02.01.2430.440	24/30	---
9254914410	02.01.2430.441	24/30	---
9254917550	02.01.2424.755	24/24	---

EBS WABCO G Type Spring Brake Chambers - Cam Brakes

Wabco Part No	EBS Part No	Type	Repair Kit
9254919000	02.01.2424.900	24/24	---
9254919010	02.01.2424.901	24/24	---
9254920000	02.01.3024.000	30/24	---
9254920010	02.01.3024.001	30/24	---
9254920020	02.01.3030.002	30/30	---
9254920030	02.01.3030.003	30/30	---
9254921010	02.01.3024.101	30/24	---
9254921020	02.01.3030.102	30/30	---
9254922000	02.01.3030.200	30/30	EKWA.47.1G
9254922010	02.01.3024.201	30/24	---
9254922030	02.01.3030.203	30/30	---
9254922040	02.01.3024.204	30/24	---
9254922050	02.01.3030.205	30/30	---
9254922080	02.01.3030.208	30/30	---
9254922090	02.01.3030.209	30/30	---
9254922130	02.01.3030.213	30/30	---
9254922210	02.01.3030.221	30/30	---
9254922310	02.01.3030.231	30/30	---
9254929030	02.01.3030.903	30/30	---
9254941050	02.01.1624.105	16/24	---
9254941080	02.01.1624.108	16/24	---
9254949100	02.01.1624.910	16/24	---
9254949110	02.01.1624.911	16/24	---
9254949200	02.01.1624.920	16/24	---
9254949220	02.01.1624.922	16/24	---
9254949230	02.01.1624.923	16/24	---
9254990000	02.01.2724.000	27/24	---
9254990010	02.01.2730.001	27/30	---
9254990030	02.01.2724.003	27/24	---
9254990040	02.01.2724.004	27/24	---
9254990110	02.01.2730.011	27/30	---
9254990120	02.01.2730.0120	27/30	EKWA.47.1G
9254990300	02.01.2730.030	27/30	---
9254990310	02.01.2730.031	27/30	---
9254990800	02.01.2724.080	27/24	---
9254990810	02.01.2724.081	27/24	---
9255001600	02.01.2024.160	20/24	---

BRAKE CHAMBERS & REPAIR KITS



EBS KNORR G Type Spring Brake Chambers - Disc Brakes

Knorr Part No	EBS Part No	Type	Repair Kit
BS8303	02.06.1616.303	16/16	---
BS8317	02.06.1627.317	16/27	---
BS8316	02.06.1627.316	16/27	---
BS8322	02.06.1627.322	16/27	---
BS8323	02.06.1627.323	16/27	---
BS8332	02.06.1616.332	16/16	---
BS8333	02.06.1616.333	16/16	---
BS8334	02.06.1616.334	16/16	---
BS8335	02.06.1616.335	16/16	---
BS8337	02.06.1616.337	16/16	---
BS8392	02.06.1824.392	18/24	---
BS8393	02.06.1824.393	18/24	---
BS8420	02.06.2024.420	20/24	---
BS8421	02.06.2024.421	20/24	---
BS8430	02.06.2024.430	20/24	---
BS8434	02.06.2024.8434	20/24	---
BS8435	02.06.2024.435	20/24	---
BS8453	02.06.2024.453	20/24	---
BS8436	02.06.2027.436	20/27	---
BS8437	02.06.2027.437	20/27	---
BS8450	02.06.2224.8450	22/24	---
BS8458	02.06.2024.458	20/24	---
BS8459	02.06.2024.459	20/24	---
BS8460	02.06.2224.460	22/24	---
BS8461	02.06.2224.461	22/24	---
BS9462	02.06.2024.462	20/24	---
BS9463	02.06.2024.463	20/24	---
BS8472	02.06.2224.472	22/24	---
BS8473	02.06.2224.473	22/24	---
BS8500	02.06.2430.500 02.06.2430.119	24/30 24/30	---
BS8502	02.06.2424.502	24/24	---
BS8503	02.06.2424.8503	24/24	---
BS8507	02.06.2424.507	24/24	---
BS8508	02.06.2424.508	24/24	---
BS8510	02.06.2424.510	24/24	---
BS8512	02.06.2424.512	24/24	---
BS8516	02.06.2424.516	24/24	---
BS8517	02.06.2424.517	24/24	---
BS8518	02.06.2424.518	24/24	---
BS8533	02.06.2424.533	24/24	---
BS8534	02.06.2424.534	24/24	---
BS8570	02.06.2424.570	24/24	---
BS8571	02.06.2424.571	24/24	---
BS8551	02.06.2430.551	24/30	---
BS8552	02.06.2430.552	24/30	---
BS8560	02.06.2414.560	24/14	---

EBS KNORR G Type Spring Brake Chambers - Disc Brakes

Knorr Part No	EBS Part No	Type	Repair Kit
BS8561	02.06.2414.561	24/14	---
BS8562	02.06.2414.562	24/14	---
BS8563	02.06.2414.563	24/14	---
BS8586	02.06.2424.586	24/24	---
BS8587	02.06.2424.587	24/24	---
BS9082	02.06.1016.082	10/16	---
BS9083	02.06.1016.083	10/16	---
BS9084	02.06.1016.084	10/16	---
BS9086	02.06.1016.086	10/16	---
BS9087	02.06.1016.087	10/16	---
BS9088	02.06.1016.088	10/16	---
BS9089	02.06.1016.089	10/16	---
BS9092	02.06.1016.092	10/16	---
BS9093	02.06.1016.093	10/16	---
BS9177	02.06.1216.177	12/16	---
BS9178	02.06.1216.178	12/16	---
BS9196	02.06.1216.196	12/16	---
BS9197	02.06.1216.197	12/16	---
BS9198	02.06.1216.198	12/16	---
BS9253	02.06.1424.253	14/24	---
BS9254	02.06.1424.254	14/24	---
BS9261	02.06.1424.261	14/24	---
BS9282	02.06.1416.282	14/16	---
BS9297	02.06.1416.297	14/16	---
BS9304	02.06.1624.304	16/24	---
BS9305	02.06.1624.305	16/24	---
BS9306	02.06.1624.306	16/24	---
BS9311	02.06.1624.311	16/24	---
BS9312	02.06.1624.312	16/24	---
BS9314	02.06.1624.314	16/24	---
BS9332	02.06.1624.332	16/24	---
BS9338	02.06.1624.338	16/24	---
BS9339	02.06.1624.339	16/24	---
BS9342	02.06.1824.342	18/24	---
BS9343	02.06.1824.343	18/24	---
BS9350	02.06.1824.350	18/24	---
BS9351	02.06.1824.351	18/24	---
BS9354	02.06.1827.354	18/27	---
BS9355	02.06.1827.355	18/27	---
BS9362	02.06.1827.362	18/27	---
BS9363	02.06.1827.363	18/27	---
BS9370	02.06.1827.370	18/27	---
BS9371	02.06.1827.371	18/27	---
BS9373	02.06.1616.373	16/16	---
BS9374	02.06.1616.374	16/16	---
BS9379	02.06.1616.379	16/16	---
BS9387	02.06.1616.387	16/16	---

EBS KNORR G Type Spring Brake Chambers - Disc Brakes

Knorr Part No	EBS Part No	Type	Repair Kit
BS9395	02.06.1616.395	16/16	---
BS9396	02.06.1616.396	16/16	---
BS9397	02.06.1616.397	16/16	---
II31227	02.06.1616.227	16/16	---
BS9404	02.06.2024.404	20/24	---
BS9405	02.06.2024.405	20/24	---
BS9406	02.06.2024.406	20/24	---
BS9409	02.06.2024.409	20/24	---
BS9410	02.06.2024.410	20/24	---
BS9418	02.06.2024.418	20/24	---
BS9419	02.06.2024.419	20/24	---
BS9425	02.06.2030.425	20/30	---
BS9426	02.06.2030.426	20/30	---
BS9429	02.06.2024.429	20/24	---
BS9451	02.06.2224.451	22/24	---
BS9461	02.06.2224.9461	22/24	---
BS9468	02.06.2214.468	22/14	---
BS9476	02.06.2024.476	20/24	---
BS9500	02.06.2424.9500	24/24	---
BS9503	02.06.2424.503	24/24	---
BS9504	02.06.2424.504	24/24	---
BS9505	02.06.2424.505	24/24	---
BS9507	02.06.2414.507	24/14	---
BS9508	02.06.2424.9508	24/24	---
BS9510	02.06.2414.510	24/14	---
BS9514	02.06.2414.514	24/14	---
BS9519	02.06.2427.519	24/27	---
BS9520	02.06.2424.520	24/24	---
BS9527	02.06.2430.527	24/30	---
BS9531	02.06.2414.531	24/14	---
BS9573	02.06.2424.573	24/24	---
BS9574	02.06.2424.574	24/24	---
BT5718	02.06.2024.718	20/24	---
BT5719	02.06.2024.719	20/24	---
BT5800	02.06.2027.800	20/27	---
K009970	02.06.2027.970	20/27	---
BT5801	02.06.2027.801	20/27	---
K009971	02.06.2027.971	20/27	---
BS9541	02.06.2024.541	20/24 HF	---
BS9506	02.06.2024.9506	24/24	---
BS9543	02.06.2424.9543	24/24 HF	---
BS9544	02.06.2424.9544	24/24 HF	---
BS9549	02.06.2024.549	20/24 HF	---
BS8328	02.06.1624.328	16/24 HFL1	---
BS8329	02.06.1624.329	16/24 HFL1	---
BS8413	02.06.2024.413	20/24 HFL1	---

EBS KNORR G Type Spring Brake Chambers - Disc Brakes

Knorr Part No	EBS Part No	Type	Repair Kit
BS8414	02.06.2024.414	20/24 HFL1	---
BS8415	02.06.2024.415	20/24 HFL1	---
BS8520	02.06.2424.8520	24/24 HFL1	---
BS8544	02.06.2424.544	24/24 HFL1	---
BS8545	02.06.2424.545	24/24 HFL1	---
BS9320	02.06.1624.320	16/24 HFL1	---
BS9321	02.06.1624.321	16/24 HFL1	---
BS9433	02.06.2024.433	20/24 HFL1	---
BS9434	02.06.2024.434	20/24 HFL1	---
BS9480	02.06.2024.480	20/24 HFL1	---
BS9481	02.06.2024.481	20/24 HFL1	---
BS9482	02.06.2024.482	20/24 HFL1	---
BS9483	02.06.2024.483	20/24 HFL1	---
BS9484	02.06.2024.484	20/24 HFL1	---
BS9535	02.06.2424.535	24/24 HFL1	---
BS9536	02.06.2430.536	24/30 HLF1	---
BS8330	02.06.1624.330	16/24 HFL3	---
BS8331	02.06.1624.331	16/24 HFL3	---
BS8426	02.06.2024.426	20/24 HFL3	---
BS8427	02.06.2024.427	20/24 HFL3	---
BS8506	02.06.2224.506	24/24 HFL3	---
BS9411	02.06.2024.411	20/24 HFL3	---
BS9412	02.06.2024.412	20/24 HFL3	---
BS9438	02.06.2024.438	20/24 HFL3	---
BS9502	02.06.2424.9502	24/24 HFL3	---
BS9491	02.06.2024.491	20/24 VOSS	---
BS9492	02.06.2024.492	20/24 VOSS	---
BS8402	02.06.2024.402	20/24 HFL3VOSS	---
BS8403	02.06.2024.403	20/24 HFL3VOSS	---
BS9302	02.06.1624.302	16/24 HFL3 VOSS	---
BS8452	02.06.2024.452	20/24 VOSS	---
BS9491	02.06.2024.491	20/24 VOSS	---
BS9492	02.06.2024.492	20/24 VOSS	---
BS8402	02.06.2024.402	20/24 HFL3VOSS	---
BS8403	02.06.2024.403	20/24 HFL3VOSS	---
BS9302	02.06.1624.302	16/24 HFL3 VOSS	---
BS8452	02.06.2024.452	20/24 VOSS	---
BT5417	02.06.2024.916	20/24	---
BT5418	02.06.2024.917	20/24	---

BRAKE CHAMBERS & REPAIR KITS



EBS WABCO G Type Spring Brake Chambers - Disc Brakes			
Wabco Part No	EBS Part No	Type	Repair Kit
9254610220	02.06.2424.022	24/24	---
9254612100	02.06.2424.210	24/24	---
9254612110	02.06.2424.211	24/24	---
9254612700	02.06.2424.270	24/24	---
9254813140	02.06.2430.314	24/30	---
9254813200	02.06.2416.320	24/16	---
9254613500	02.06.2416.350	24/16	---
9254248000	02.06.1616.800	16/16	---
9254248010	02.06.1616.801	16/16	---
9254248300	02.06.1616.830	16/16	---
9254248310	02.06.1616.831	16/16	---
9254261000	02.06.1216.100	12/16	---
9254262000	02.06.1416.200	14/16	---
9254262010	02.06.1416.201	14/16	---
9254601000	02.06.2024.100	20/24	---
9254601010	02.06.2024.101	20/24	---
9254600270	02.06.2024.027	20/24	---
9254600320	02.06.2024.032	20/24	---
9254600600	02.06.2024.060	20/24	---
9254600610	02.06.2024.061	20/24	---
9254615010	02.06.2424.501	24/24	---
9254810210	02.06.2424.021	24/24	---
9254610230	02.06.2424.023	24/24	---
9254610250	02.06.2424.025	24/24	---
9254610270	02.06.2424.027	24/24	---
9254610350	02.06.2424.035	24/24	---
9254610510	02.06.2424.1051	24/24	---
9254610520	02.06.2424.052	24/24	---
9254610950	02.06.2424.095	24/24	---
9254610960	02.06.2424.096	24/24	---
9254611010	02.06.2424.101	24/24	---
9254611020	02.06.2424.102	24/24	---
9254611030	02.06.2424.103	24/24	---
9254611100	02.06.2424.110	24/24	---
9254811140	02.06.2424.114	24/24	---
9254611200	02.06.2424.120	24/24	---
9254611300	02.06.2424.130	24/24	---
9254611310	02.06.2424.131	24/24	---
9254611500	02.06.2416.150	24/16	---
9254611530	02.06.2416.153	24/16	---
9254611600	02.06.2430.160	24/30	---
9254611720	02.06.2424.1720	24/24	---
9254611730	02.06.2424.173	24/24	---
9254611910	02.06.2416.191	24/16	---
9254612310	02.06.2424.231	24/24	---
9254612410	02.06.2424.241	24/24	---

EBS WABCO G Type Spring Brake Chambers - Disc Brakes			
Wabco Part No	EBS Part No	Type	Repair Kit
9254812520	02.06.2424.252	24/24	---
9254612710	02.06.2424.271	24/24	---
9254612900	02.06.2416.290	24/16	---
9254612930	02.06.2424.293	24/24	---
9254613300	02.06.2424.3300.	24/24	---
9254613310	02.06.2424.3310.	24/24	---
9254613510	02.06.2416.351	24/16	---
9254614690	02.06.2430.469	24/30	---
9254614700	02.06.2430.470	24/30	---
9254614710	02.06.2430.471	24/30	---
9254614720	02.06.2430.472	24/30	---
9254614800	02.06.2430.480	24/30	---
9254635100	02.06.1824.510	18/24	---
9254635110	02.06.1824.511	18/24	---
9254640400	02.06.1616.040	16/16	---
9254644500	02.06.1616.450	16/16	---
9254644510	02.06.1616.451	16/16	---
9254644520	02.06.1616.452	16/16	---
9254644600	02.06.1616.460	16/16	---
9254644610	02.06.1616.461	16/16	---
9254645000	02.06.1624.500	16/24	---
9254645010	02.06.1624.501	16/24	---
9254661020	02.06.1216.102	12/16	---
9254670000	02.06.2224.000	22/24	---
9254670020	02.06.2224.002	22/24	---
9254670040	02.06.2224.004	22/24	---
9254670050	02.06.2224.005	22/24	---
9254670120	02.06.2224.012	22/24	---
9254670160	02.06.2224.016	22/24	---
9254670200	02.06.2224.020	22/24	---
9254670240	02.06.2224.024	22/24	---
9254681000	02.06.1416.100	14/16	---
9254681400	02.06.1416.140	14/16	---
9254681410	02.06.1416.141	14/16	---
9254682500	02.06.1416.250	14/16	---
9254682510	02.06.1416.251	14/16	---
9254682520	02.06.1416.252	14/16	---
9254800200	02.06.2024.020	20/24	---
9254800210	02.06.2024.021	20/24	---
9254800340	02.06.2024.034	20/24	---
9254800350	02.06.2024.035	20/24	---
9254800400	02.06.2024.040	20/24	---
9254801210	02.06.2024.012	20/24	---
9254801210	02.06.2024.121	20/24	---
9254809610	02.06.2024.961	20/24	---
9254809620	02.06.2024.962	20/24	---

EBS WABCO G Type Spring Brake Chambers - Disc Brakes			
Wabco Part No	EBS Part No	Type	Repair Kit
9254810000	02.06.2424.000	24/24	---
9254810120	02.06.2424.012	24/24	---
9254810130	02.06.2424.013	24/24	---
9254810150	02.06.2424.015	24/24	---
9254810300	02.06.2424.030	24/24	---
9254810310	02.06.2424.031	24/24	---
9254810320	02.06.2424.032	24/24	---
9254810500	02.06.2424.050	24/24	---
9254810510	02.06.2424.051	24/24	---
9254810600	02.06.2430.060	24/30	---
9254810700	02.06.2430.070	24/30	---
9254810800	02.06.2424.080	24/24	---
9254811000	02.06.2430.100	24/30	---
9254811010	02.06.2430.101	24/30	---
9254811020	02.06.2430.102	24/30	---
9254811030	02.06.2430.103	24/30	---
9254811080	02.06.2424.108	24/30	---
9254811100	02.06.2424.1100	24/24	---
9254811130	02.06.2424.113	24/24	---
9254811150	02.06.2424.115	24/24	---
9254811160	02.06.2424.116	24/24	---
9254811170	02.06.2424.117	24/24	---
9254811200	02.06.2430.120	24/30	---
9254811210	02.06.2430.121	24/30	---
9254811220	02.06.2430.122	24/30	---
9254811230	02.06.2430.123	24/30	---
9254811250	02.06.2424.125	24/24	---
9254811520	02.06.2424.152	24/24	---
9254811530	02.06.2424.153	24/24	---
9254811540	02.06.2424.154	24/24	---
9254811550	02.06.2424.155	24/24	---
9254811560	02.06.2424.156	24/24	---
9254811570	02.06.2424.157	24/24	---
9254811600	02.06.2424.160	24/24	---
9254811610	02.06.2424.161	24/24	---
9254811620	02.06.2424.162	24/24	---
9254811630	02.06.2424.163	24/24	---
9254811700	02.06.2424.170	24/24	---
9254811710	02.06.2424.171	24/24	---
9254811810	02.06.2424.181	24/24	---
9254812000	02.06.2424.200	24/24	---
9254812300	02.06.2416.230	24/16	---
9254812310	02.06.2416.231	24/16	---
9254812510	02.06.2424.251	24/24	---
9254812530	02.06.2424.253	24/24	---
9254813000	02.06.2424.300	24/24	---

EBS WABCO G Type Spring Brake Chambers - Disc Brakes			
Wabco Part No	EBS Part No	Type	Repair Kit
9254813120	02.06.2430.312	24/30	---
9254813130	02.06.2430.313	24/30	---
9254813200	02.06.2416.320	24/16	---
9254813210	02.06.2416.321	24/16	---
9254813310	02.06.2424.331	24/24	---
9254813320	02.06.2424.332	24/24	---
9254813330	02.06.2424.333	24/24	---
9254813340	02.06.2424.334	24/24	---
9254813400	02.06.2424.340	24/24	---
9254813420	02.06.2430.342	24/30	---
9254813450	02.06.2430.345	24/30	---
9254813460	02.06.2430.346	24/30	---
9254813600	02.06.2424.360	24/24	---
9254813610	02.06.2424.361	24/24	---
9254814200	02.06.2424.420	24/24	---
9254814210	02.06.2424.421	24/24	---
9254814240	02.06.2424.424	24/24	---
9254814250	02.06.2424.425	24/24	---
9254840200	02.06.1624.020	16/24	---
9254840210	02.06.1624.021	16/24	---
9254840220	02.06.1624.022	16/24	---
9254840230	02.06.1624.023	16/24	---
9254861010	02.06.1216.101	12/16	---
9254861040	02.06.1216.104	12/16	---
9254861060	02.06.1216.106	12/16	---
9254861070	02.06.1216.107	12/16	---
9254863000	02.06.1016.300	10/16	---
9254863010	02.06.1016.301	10/16	---
9254863050	02.06.1016.305	10/16	---
9254863060	02.06.1016.306	10/16	---
9254863070	02.06.1016.307	10/16	---
9254864000	02.06.1616.400	16/16	---
9254864010	02.06.1616.401	16/16	---
9254864110	02.06.1416.411	14/16	---
9254864200	02.06.1416.420	14/16	---
9254864210	02.06.1416.421	14/16	---
9254870000	02.06.2224.000HF	22/24	---
9254870010	02.06.2224.001	22/24	---
9254870100	02.06.2224.010	22/24	---
9254870160	02.06.2224.0160	22/24	---
9254870170	02.06.2224.0170	22/24	---
9254870210	02.06.2224.021	22/24	---
9254870220	02.06.2224.022	22/24	---
9254871100	02.06.2224.011	22/24	---
9254880000	02.06.1424.000	14/24	---
9254880010	02.06.1424.001	14/24	---

BRAKE CHAMBERS & REPAIR KITS

EBS WABCO G Type Spring Brake Chambers - Disc Brakes

Wabco Part No	EBS Part No	Type	Repair Kit
9254880100	02.06.1424.010	14/24	---
9254880120	02.06.1424.012	14/24	---
9254880140	02.06.1424.014	14/24	---
9254880150	02.06.1424.015	14/24	---
9254880200	02.06.1424.020	14/24	---
9254880210	02.06.1424.021	14/24	---
9254880400	02.06.1424.040	14/24	---
9254880410	02.06.1424.041	14/24	---
9254890200	02.06.2724.020	27/24	---
9254891000	02.06.2730.100	27/30	---
9254891010	02.06.2730.101	27/30	---
9254610600	02.06.2424.060	24/24	---
9254610610	02.06.2424.061	24/24	---
9254610620	02.06.2424.062	24/24	---
9254801200	02.06.2024.120	20/24	---
9254811650	02.06.2424.165	24/24	---
9254610200	02.06.2424.020	24/24	---
9254811500	02.06.2424.150	24/24	---
9254811500	02.06.2424.150	24/24	---
9254811510	02.06.2424.151	24/24	---
9254812600	02.06.2424.260	24/24	---
9254840100	02.06.1624.010H3	16/24	---
9254840110	02.06.1624.011H3	16/24	---
9254800100	02.06.2024.010	20/24	---
9254800110	02.06.2024.011	20/24	---
9254811640	02.06.2424.164	24/24	---
9254811720	02.06.2424.172	24/24	---
9254860100	02.06.1224.010	12/24	---
9254860110	02.06.1224.011	12/24	---
9254860400	02.06.1416.040	14/16	---
9254880600	02.06.1416.060	14/16	---
9254880610	02.06.1416.061	14/16	---
9254800040	02.06.2024.004	20/24	---
9254800050	02.06.2024.005	20/24	---
9254813470	02.06.2430.347	24/30	---
9254813300	02.06.2424.330	24/24	---
9254813360	02.06.2424.336	24/24	---

EBS WABCO Flange Mounted Single Diaphragm Brake Chambers

Wabco Part No	EBS Part No	Type	Repair Kit
4230690010	02.03.09.001	9	---
4230690020	02.03.09.002	9	---
4230690050	02.03.09.005	9	---
4230720000	01.05.00.24	16	---
4230760200	02.03.24.020	24	---
4230820100	02.03.17.010	17	---

EBS KNORR Flange Mounted Spring Brake Chambers

Knorr Part No	EBS Part No	Alt. Part No	Type
BY9263	02.03.1424.263	---	14/24
BY9264	---	03.15.00.63	14/24
4254530130	02.03.1016.013	---	10.5/16
1118525000	02.03.1016.153	---	10/16
1118526000	02.03.1016.154	---	10/16
BY9321	02.03.1624.321	---	16/24
BY9338	02.03.1820.338	---	18/20
BY9339	02.03.1820.339	---	18/20
KZ1290/3	02.03.1424.2903	---	14/24
KZ1290/4	02.03.1424.2904	---	14/24

EBS WABCO Flange Mounted Spring Brake Chambers

Wabco Part No	EBS Part No	Alt. Part No	Type
4253520000	02.03.0916.000	---	9/16
4253520010	02.03.0916.001	---	9/16
4253540000	02.03.1216.000	---	12/16
4253540010	02.03.1216.001	23.812.16.07	12/16
4254541110	02.03.1216.111	---	12/16
4253550100	02.03.1424.010	---	14/24
4253550110	02.03.1424.011	---	14/24
4253560000	02.03.1624.000	---	16/24
4253560010	02.03.1624.001	---	16/24
4253520010	02.03.0916.001	---	9/16
4254520220	02.03.0916.022	---	9/16
4254520230	02.03.0916.023	03.15.00.27	9/16
4254521000	02.03.0916.100	---	9/16
4254521010	02.03.0916.101	---	9/16
4254521020	02.03.0916.102	---	9/16
4254521030	02.03.0916.103	---	9/16
4254521040	02.03.0916.104	---	---
4254521050	02.03.0916.105	03.809.16.00	9/16
4254521020	---	03.809.16.01	9/16
4254530100	02.03.1016.010	03.15.00.88	10.5/16
4254530110	02.03.1016.011	03.15.00.89	10.5/16
4254530120	02.03.1016.012	---	10.5/16
4254541110	02.03.1216.110	---	12/16
4254541120	02.03.1216.112	---	12/16
4254541130	02.03.1216.113	---	12/16
4254563100	02.03.1716.310	---	17/16
4254563110	02.03.1716.311	---	17/16
4254563120	02.03.1716.312	---	17/16
4254563130	02.03.1716.313	---	17/16
4254510500	02.03.2424.050	---	24/24
4254510501	02.03.2424.051	---	24/24

EBS BOSCH Flange Single			
Wabco Part No	EBS Part No	Type	Repair Kit
R02.03.14.504	0482023504000	14	---

EBS KNORR Single Tube Mounted Brake Chambers



EBS KNORR Single Tube Mounted Spring Brake Chambers

EBS WABCO Tube Mounted Single Diaphragm Brake Chambers			
Wabco Part No	EBS Part No	Type	Repair Kit
4230700500	02.04.12.050	12	---
4230701200	02.03.12.120	21	---
4230762000	02.04.24.200	24	---
4231430020	01.56.00.30	12	---

WABCO Single Tube Mounted Brake Chambers



EBS KNORR Single Tube Mounted Brake Chambers			
Wabco Part No	EBS Part No	Type	Repair Kit
EF90YE	02.04.09.90YE	9	---
EF90YES	02.04.09.90YES	9	---
EF120FY	02.04.12.120FY	12	---
EF120YES	02.04.12.120YES	12	---
1189072-01	R02.04.09.9072	9	---

EBS KNORR Tube Mounted Spring Brake Chamber - Repair Kits	
Knorr Part No	Repair Kit
BZ7239	EKKB.10
BZ7240	EKKB.10
BZ7251	EKKB.10
BZ7252	EKKB.10

EBS KNORR Tube Mounted Spring Brake Chambers			
Knorr Part No	EBS Part No	Alt. Part No	Type
1138097F	R02.04.0916.113	---	9/16
BFM122	02.04.1284.122	---	12/84
BY7136	02.04.0916.136	---	9/16
BY9153	02.03.1016.153	03.15.00.91	10.5/16
BY9205	02.04.1220.9205	03.812.16.20	12/20
BY9205	02.04.1220.9205	23.812.16.03	12/20
BY9251	02.04.1420.251	23.814.16.00	14/20
BY9260	---	23.814.24.04	14/20
BY9303	02.04.1624.19.3	---	16/24
BY9321	02.04.1624.321	---	16/24
BY9328	02.04.1624.328	---	16/24
BY9350	02.04.1824.350	---	18/24
BY9351	02.04.1824.351	---	18/24
BY9372	02.04.1824.372	---	18/24
BY9401	02.04.2024.401	---	20/24
BY9401	02.04.2024.401	23.820.24.11	20/24
BY9451	---	23.822.24.05	22/24
KZ1192/2	02.04.0912.192	---	12

EBS WABCO Tube Mounted - Spring Brake Chambers				
Wabco P. No	EBS Part No	Alt. Part No	Type	Repair Kit
4253260500	02.04.0909.050	---	9/9	EKWA.10
4253260520	02.04.0909.052	---	9/9	EKWA.10
4253270540	02.04.1220.054	---	12/12	EKWA.10
4253270640	02.04.1212.064	---	12/12	EKWA.10
4253311010	R02.04.2416.101	---	24/16	---
4253460020	---	03.812.16.27	12/24	EKWA.10
4253520500	02.04.0916.050	03.03.00.46	9/16	EKWA.10
4253540500	---	23.812.16.04	12/16	---
4254571000	---	23.818.24.05	18/24	---
4254540500	02.04.1216.050	---	12/16	---



BRAKE CHAMBERS & REPAIR KITS

EBS Spring Brake Chamber - Portion & Clamp Kit



Please note this comes with the Clamp Band, Diaphragm, Bolt & Pipe Fittings

EBS Part No	Alternative	Type	Repair Kit
02.04.1216.PB	---	12/16	---

Diaphragms, Clamp Rings, Gaiters, Springs, Yokes & Adaptors can be found on pages 2.21 To 2.23

EBS BENDIX Remote Spring Brake Chambers - Disc & Disc Parking Brakes

EBS Part No.	Bendix Part No.	Type	Repair Kits
1186753	02.14.6753	50	EKKB.523.3
1189449	02.14.9449	50	EKKB.523.3
1186754	02.14.6754	61	EKKB.523.3
1189458	02.14.9458	61	EKKB.523.3
1188823	02.14.8823	61	EKKB.523.3
1188845	02.14.8845	61	EKKB.523.3
KZ1254	02.14.1254	61	EKKB.523.3



EBS MAXIBRAKE Spring Brake Chambers

03.94.00.05	
	
Alternative Part No	NR1PH75
Repair Kits	---

03.95.00.38	
	
Alternative Part No	1575405
Repair Kits	EKCD.1.3 EKCD.1.3.CS

N356743	
	
Alternative Part No	356743
Repair Kits	---

KNORR BREMSE - Spring Brake Chambers

Bendix Part No	EBS Part No	Type	Repair Kit - Gaiter	Repair Kit	Diaphragm	Image
K2E4001X50	R02.14.K001	9/47	Metric	---	---	
K2E4002X50	R02.14.K002	9/47	Metric	---	EK99.3.9B.45	
K2B0504X50	R02.14.K003	20/80	Metric	EKKB.38.3	EKPP.3.20B.64	
K2B0502X50	R02.14.K005	16/80	Metric	EKKB.38.3	EKPP.3.16B.64	
K2C2004X50	R02.14.K006	30/80	Imperial	EKKB.38.B	EKPP.3.30B.64	
K2D0706X50	R02.14.K007	24/80	Metric	EKKB.38.3	EKPP.3.24B.64	
K2B0522X50	R02.14.K008	30/105	Metric	EKKB.38.B	EKPP.3.30B.64	
K2B1096X50	R02.14.K009	30/80	Metric	EKKB.38.B	EKPP.3.30B.64	
K2B1097X50	R02.14.K010	30/80	Metric	EKKB.38.B	EKPP.3.30B.64	
K2C0528X50	R02.14.K011	24/80	Imperial	EKKB.38.3	EKPP.3.24B.64	

EBS WABCO Spring Brake Locking Cylinder

Wabco Part No	EBS Part No	Repair Kit	Image
4253110040	24.01.9004	EKWA.10.1	

BRAKE CHAMBERS & REPAIR KITS



MGM MJS Series Spring Brake Chambers - Cam Brakes

Part No	Type	Port Type	Alternative 1	Alternative 2	Alternative 3	Alternative 4
MJS2024ET549	20/80	Metric	K2B0504X50	---	---	---
MJS2424ET549	24/80	Metric	K2B0506X50	---	---	---
MJS2424ET551	24/80	Imperial	K2B0528X50	---	---	---
MJS2430ET549	24/105	Metric	K2B0514X50	BZ7589	1137279	1446052
MJS3028ET200	30/98	Imperial	K2B1101X50	1608006	---	---
MJS3028ET549	30/98	Metric	K2B0521X50	K2B1222X50	1606834	654466X
MJS3028ET551	30/98	Imperial	K2B0543X50	K2C0543SXA	---	---
MJS3030ET152	30/105	Metric	510260645	---	---	---
MJS3030ET153	30/105	Metric	510260647	---	---	---
MJS3030ET549	30/105	Metric	K2B0522X50	---	---	---



MGM MJB Series Spring Brake Chambers - Disc Brakes

Part No	Type	Port Type	Alternative 1	Alternative 2	Alternative 3	Alternative 4
MJB1724ET053	16/24	Metric	5001862853	68324692	---	---
MJB1724ET749	16/24	Metric	MJB1724ET053	---	---	---
MJB2024ET702	20/24	Metric	5001860203	68323934	---	---
MJB2124ET702	20/24	Metric	0501317523	31932124	5010404132	503128324
MJB2030ET702	20/30	Metric	5001848402	5010525491	5010525493	68033182N2P
MJB2030ET703	20/30	Metric	MJB2030ET712	5001848403	5010525492	5010525494
MJB2430ET054	24/30	Metric	10762618	---	---	---

Diaphragms, Clamp Rings, Gaiters, Springs, Yokes
& Adaptors Can Be Found On Pages 2.21 To 2.23



MGM MJS Series Spring Brake Chambers - Cam Brakes

EBS Part No	Type	Port Type	Alternative 1	Alternative 2	Alternative 3	Alternative 4
02.01.1216.051	12/16	Metric	MJS1216AT051	---	---	---

MGM MJS Single Spring Brake Chambers

EBS Part No	Type	Port Type	Alternative 1	Alternative 2	Alternative 3	Alternative 4
NAB1430202	30	Metric	1430202	---	---	---



EBS MGM Magnum Spring Brake Chambers

EBS Part No	Type	Alternative	Repair Kit	Repair Kit
02.11.2480	24/80	4124-549	EKBE.39.7	EKBE.39.7C
02.11.3098	30/98	4132549	EKBE.39.7	EKBE.39.7C

**EBS Bendix "K" Type Spring Brake Chambers**

EBS Part No	Knorr Part No	Type	Port Type	Repair Kit
---	K2B0504X50	20/80	Metric	---
02.12.1134	K2B0506X50	24/80	Metric	EKBE.38.3
02.12.1302	K2B0514X50	24/105	Metric	EKBE.38.3
02.12.0516	K2B0516X50	27/80	Metric	EKBE.39.4
R02.12.0521	K2B0521X50	30/98	Metric	EKBE.39.4
02.12.1135	K2B0521X50 K2B1222X50	30/98	Metric	EKBE.39.4
02.12.1123	K2B0528X50	24/80	Imperial	EKBE.38.3
02.12.1124	K2B0543X50	30/98	Imperial	EKBE.39.4
02.12.1101	K2B1101/1	30/98	Imperial	EKBE.39.B

**EBS Bendix "K" Type Spring Brake Chambers Portion**

EBS Part No	Knorr Part No	Type	Port Type	Repair Kit
02.01.3030PB	KY1688	30/98	Metric	EKBE.39.4

EBS HINO Spring Brake Chambers - Flange & Stud Mount

02.37.2424.01		HINO30S		02.37.30.01	
Inf.	2 Stud	Inf.	4 Stud	Inf.	4 Stud
Type	24/24	Type	30 Single	Type	30 Maxibrake
02.37.3024.01		02.37.3024.FL		02.37.3024.FR	
Inf.	4 Stud	Inf.	Flange Left Hand	Inf.	Flange Right Hand
Type	30/24	Type	30/24	Type	30/24

Diaphragms, Clamp Rings, Gaiters, Springs, Yokes & Adaptors Can Be Found On Pages 2.21 To 2.23

EBS CLAYTON Spring Brake Cylinder



EBS Part No.	Alternative Part No.	Type	Repair Kit
R02.15.2527	APGA2527	R75 Imperial	---
02.15.2537	APGA2537/C1EU 9259500157	R75 Imperial	---
N4253620020	4253620020	R75 Imperial	---

EBS KNORR Piston Cylinder Spring Brake Chambers



EBS Part No.	Knorr Part No.	Type	Repair Kit
02.16.6425	BZ6425	100/150	EKKB.11.6
02.16.6517	BZ6517	115/150	EKKB.11.2
02.16.6621	BZ6621	125/150	EKKB.11.1

EBS WABCO 164.128.940.80 Series Spring Brake Chambers

Wabco Part No	Repair Kit	Image
N16412894	EKWA.72	



Diaphragms - General								
EBS Part No	Type	Alternative	Alternative	Alternative	A (mm)	B (mm)	C (mm)	
EKPP.3.9B.45	9 MS	8971204954	272489	KY1505/1	128	79	31	
EKPP.3.9B.50	9 LS	8017209	B.74478	---	128	71	30	
EKPP.3.12/16.LS	12/16 LS	8971219234	---	---	162	79	43	
EKPP.3.12B.45	12 SS	KY1505/2	8017112	A.75056.3	139	79	28	
EKPP.3.12B.50	12 MS	8971205054	8017212	B.7447.9	139	79	30	
EKPP.3.14B.57	14 SS	8971216104	8017114	B.61290	147	79	32	
EKPP.3.14B.64	14 MS	8971216154	8017214	B.54871	147	79	41	
EKPP.3.16B.57	16 SS	8971205104	8017116	A.75056.4	158	100	32	
EKPP.3.16B.64	16 MS	8971205154	8017216	B.56649	158	100	38	
EKPP.3.16B.76	16 LS	8971205164	8017316	1188264	158	100	47	
EKPP.3.20B.57	20 SS	8971205204	8017120	A.75056.5	168	106	32	
EKPP.3.20B.64	20 MS	8971205254	8017220	B.58894	168	106	38	
EKPP.3.20B.76	20 LS	8971205264	8017320	1186260	168	106	47	
EKPP.3.24B.64	24 MS	8971205354	8017241	B.64322	179	115	39	
EKPP.3.24B.76	24 LS	8971205364	8017424	1186261	179	115	47	
EKPP.3.27B.64	27 MS	8971205474	8017227	1190023	200	120	34	
EKPP.3.30B.64	30 MS	8971205404	8017130	A.75056.7	200	139	33	
EKPP.3.30B.76	30 LS	8971205464	8017430	B.59171	200	139	48	
EKPP.3.36B.76	36 LS	8971205504	8017136	1185301	224	165	46	
EKPP.3.36B.XLS	36 XLS		---	---	224	165	45	

Diaphragms - Rolling					
EBS Part No	Type	Alternative	A	B	C
T16RD	16	C72596	157	104	28
T20RD	20	C72336	168	115	28
T24RD	24	C72337	178	128	28



EBS Clamp Ring Sets c/w Nuts & Bolts

EBS Part No	Type	Image
NSK2950/6	16	
NSK2950/7	20	
NSK2950/8	24	
NSK2950/9	30	

EBS Push Rods - Cam Brakes (16mm Thread)

EBS Part No	Type	Image
NC717	16	
NC718	20	
NC719	24	
NC720	30	

EBS Rubber Gaiters

GAITER-1		GAITER-2		GAITER-3		EKKB.523.3	
Application	Disc Brake	Application	Cam Brake	Application	Cam Brake	Application	Disc Parking Actuators

EBS Push Rods - Disc Brakes

EBS Part No	Type	Image
NT10DP	10	
NT12DP	12	
NT14DP	14	
NT16DP	16	
NT18DP	18	
NT20DP	20	
NT24DP	24	
NT30DP	30	

EBS Brake Chamber Return Spring

EBS Part No	Type	Image
SP18	Universal	
SP20	Universal	

EBS Yoke Assemblies

YOKE1		YOKE3		YOKE4		YOKE5	
Application	Long Version 16mm Thread 14mm Pin	Application	16mm Thread 16mm Pin	Application	5/8" Thread 14mm Pin	Application	Short Version 16mm Thread 1/2" Pin
YOKE6		YOKE7		YOKE8		YOKE9	
Application	Short Version 16mm Thread 14mm Pin	Application	ROR Disc Brake Version 16mm Thread 14mm Pin	Application	Deep Throat Version 16mm Thread 14mm Pin Alt: 003033609	Application	5/8" UNF Thread 1/2" Pin Alt: 228790

EBS Adaptors

<p>4711</p>  <p>Application Male - M16x1.5 Female - M22x1.5 VOSS</p>	<p>4713</p>  <p>Application Male - M22x1.5(Std) Female - M22x1.5 VOSS</p>	<p>4759</p>  <p>Application 16MM VOSS</p>	<p>4760</p>  <p>Application 22MM VOSS</p>
<p>7604</p>  <p>Application Male - M22x1.5 Female - M16x1.5</p>	<p>7606</p>  <p>Application Male - M16x1.5 Female - 1/4 BSP</p>	<p>7611</p>  <p>Application Male - 1/4 BSP Female - M16x1.5</p>	<p>7613G</p>  <p>Application Male 1/ 2 bsp- Female M22X1,5</p>
<p>7614</p>  <p>Application Male - 22 Female - 1/2 BSP</p>	<p>7615</p>  <p>Application Male - 3/8 BSP Female - M16x1.5</p>	<p>7616</p>  <p>Application Male - M16x1.5 Female - 3/8 BPS</p>	<p>7617</p>  <p>Application Male M16x1.5 Female M22 x1.5</p>
<p>7618</p>  <p>Application M16X1.5- 1/2" BSP Male to Female</p>	<p>7868T</p>  <p>Application Male - M16x1.5 Male - M16x1.5 C/W T&O</p>	<p>EKBE.39.14</p>  <p>Application Male M22x1.5 Female - 1/4 BSP (PACK OF 2)</p>	<p>EKBE.39.38</p>  <p>Application Male M22x1.5 Female - 3/8 BSP (PACK OF 2)</p>

BRAKE CHAMBERS & REPAIR KITS

EBS BENDIX REPAIR KITS



For EBS Bendix MGM T24 4025102 Spring Brake Chamber



EBS BOSCH 0482 Series Spring Brake Chambers- Repair Kits

EKBO.712AM OR EKBO.72	
Alternative	
1.487.010.188	---
Type	
130mm Version To Suit 0482074003000 0004312414 0004317614 0004318614 8850410600	150mm Version To Suit 0482071008000 0482071011000 0004312114 0004317714 0004314814

EKBO.47
Alternative
1.487.010.063
Type
Type 24 To Suit 0482512 series

EKBO.48
Alternative
1.487.010.117
Type
Type 30 To Suit 0482512 Series

EKBO.49
Alternative
1.487.010.128
Type
Type 12/16 to Suit 04825133 Series & 04825134 Serie

EBS KNORR BREMSE REPAIR KITS

<p>EKKB.10</p> 	<p>EKKB.11.1</p> 	<p>EKKB.11.2</p> 	<p>EKKB.11.6</p> 
<p>EKKB.38</p>  <p>Alternative I82622 Type 24 For BZ73 / BZ74 Series</p>	<p>EBS KNORR BZ73 / 74 Series Spring Portion Only</p> 	<p>EKKB.39</p>  <p>Alternative I87237 Type 30 For BZ74 / BZ75 Series</p>	<p>EBS KNORR BZ74 / 75 Series Spring Portion Only</p> 

EBS MAXIBRAKE REPAIR KITS

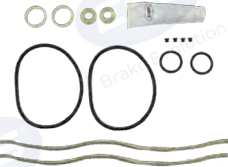
<p>EKCD.1.3</p> 	<p>EKCD.1.3.CS</p> 
---	--

EBS MGM REPAIR KITS

<p>EKBE.39.7</p> 	<p>EKBE.39.7C</p> 
---	---

SPRING BRAKE CHAMBER FITTING KITS

<p>EKS.1000</p> 	<p>EKS.1001</p> 
---	---

EBS STEYR DIAPHRAGM CYLINDER REPAIR KITS

<p>EKKP.24.1 (STEYR Ref 79100360728)</p> 

Diaphragms, Clamp Rings, Gaiters, Springs, Yokes & Adaptors can be found on pages 2.23 To 2.26

EBS WABCO REPAIR KITS



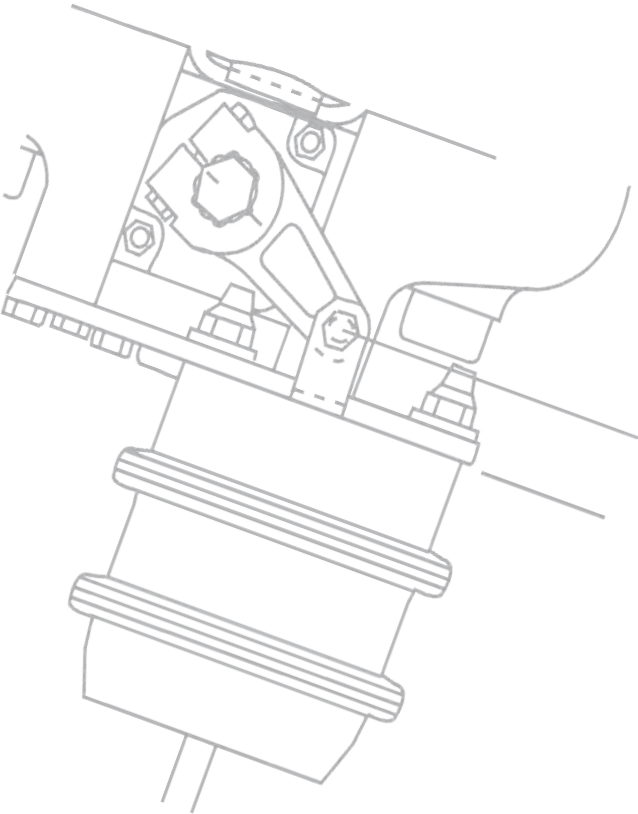
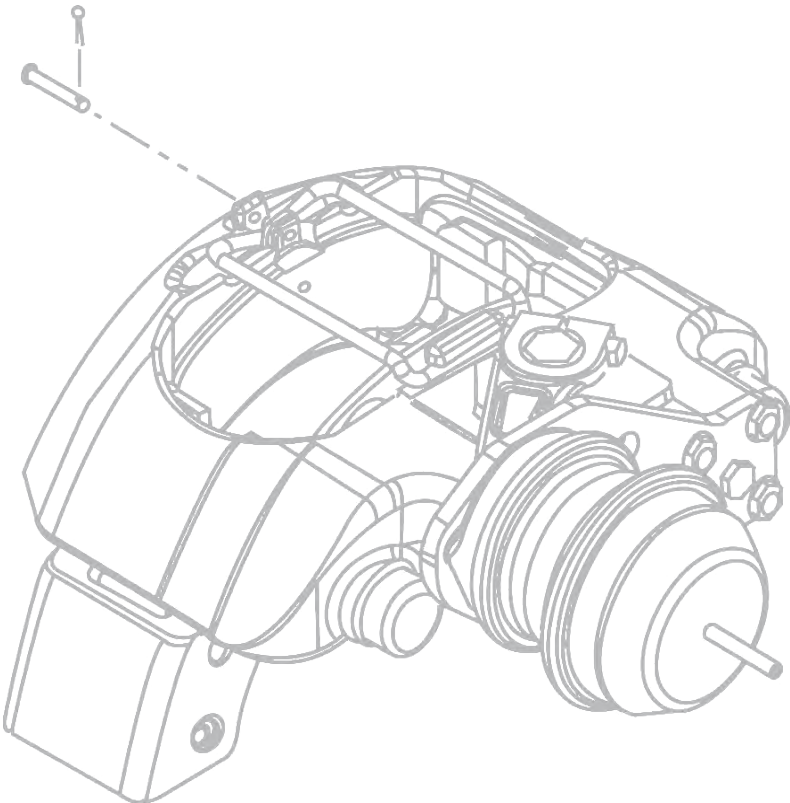

CALIPERS & REPAIR KITS



The EBS range of “NEW” calipers now available are manufactured and assembled using high quality castings, components and processes producing a brand new, competitive range of commercial vehicle calipers and components.

To compliment this range, EBS also offers original and remanufactured calipers as well as repair kits and components under its own successful brand.

EBS Calipers - IVECO

EBS Part No	Alternative Part No	Application	Application Part No	Image
03.25.002	42533002	IVECO EUROCARGO	42534121	A
03.25.004	42533004	IVECO EUROCARGO	42534122 500352569	B
03.25.0072	42560072	IVECO DAILY	---	K
03.25.0073	42560073	IVECO DAILY	---	L
03.25.189	42559189	IVECO	122980008	C
03.25.190	42559190	IVECO	122980009	D
03.25.201	42559201	IVECO	504234189	A
03.25.202	42559202	IVECO	504234190	B
03.25.203	42559203	IVECO	122980308	A
03.25.204	42559204	IVECO	122980309	B
03.25.300	42532300	IVECO	42534115	C
03.25.301	42532301	IVECO	42534116	D
03.25.302	42532302	IVECO EUROCARGO	42534117	A
03.25.303	42532303	IVECO EUROCARGO	42532303 42533008 42534118	B
03.25.304	42532304	IVECO EUROCARGO	42532304 42534119	C
03.25.305	42532305	IVECO EUROCARGO	42532305 42534120	D
03.25.4758	42554758	IVECO DAILY	504120969	E
03.25.4759	42554759	IVECO DAILY	504120970	F
03.25.8189	42548189	IVECO DAILY	504074543	G
03.25.8190	42548190	IVECO DAILY	504074544	H
03.25.9617	42559617	IVECO DAILY	504074522	I
03.25.9618	42559618	IVECO DAILY	504074523	J

NEW



CALIPERS & REPAIR KITS

EBS "NEW" Calipers - KNORR BREMSE

EBS Part No	Model	Alternative Part No	Alternative Part No
03.07.001	SB7	K003782	K003796
03.07.002	SB7	K003781	K003795
03.07.003	SB7	K003784	K003786
03.07.004	SB7	K003783	K003785
03.07.013	SB7	K003800	K003798
03.07.014	SB7	K003799	K003797
03.07.019	SB7	K003806	---
03.07.020	SB7	K003805	---
03.07.023	SB7	K003810	---
03.07.024	SB7	K003809	---
03.07.025	SB7	K003811	---
03.07.026	SB7	K003812	---
03.07.027	SB7	K003815	---
03.07.028	SB7	K003816	---
03.07.029	SB7	K002797	---
03.07.030	SB7	K002798	---
03.07.065	SB7	K014065	---
03.07.066	SB7	K014066	---
03.07.073	SK7	K012633	K011545
03.07.074	SK7	K012634	K011546
03.07.113	SB7	K013160	---
03.07.114	SB7	K013161	---
03.07.119	SB7	K003808	---
03.07.120	SB7	K003807	---
03.07.123	SB7	K003814	---
03.07.124	SB7	K003813	---
03.07.610	SN5	K005610	---
03.07.611	SN5	K005611	---
03.07.161	SN6	K009161	---
03.07.162	SN6	K009162	---
03.07.173	SN6	K003779	K013173
03.07.174	SN6	K003780	K013174
03.07.175	SN6	K003791	K013175
03.07.176	SN6	K003792	K013176
03.07.177	SN6	K003793	K013177
03.07.178	SN6	K003794	K013178

EBS Part No	Model	Alternative Part No	Alternative Part No
03.07.380	SL7	K052380K50	---
03.07.381	SL7	K052381K50	---
03.07.382	SL7	K052382K50	---
03.07.383	SL7	K052383K50	---
03.07.390	SM7	K052390K50	---
03.07.391	SM7	K052391K50	---
03.07.528	SM7	K046528K50	RK046528
03.07.529	SM7	K046529K50	RK046529
03.07.570	SN5	K004570	---
03.07.571	SN5	K004571	---
03.07.572	SN5	K004572	---
03.07.573	SN5	K004573	---
03.07.739	SK7	K151739K50	---
03.07.740	SK7	K151740K50	---
03.07.763	SN6	K026763	---
03.07.764	SN6	K026764	---
03.07.962	SB7	K002962	---
03.07.963	SB7	K002963	---
03.07.964	SB7	K002964	---
03.07.965	SB7	K002965	---
03.07.3797	SB7	K003797	---
03.07.3798	SB7	K003798	---



EBS "NEW" Calipers - MERITOR

NEW

EBS Part No	Model	Alternative Part No	Image
03.36.536	D DUCO	LRG536	A
03.36.537	D DUCO	LRG537	A
03.36.572	ELSA 2	LRG572	B
03.36.573	ELSA 2	LRG573	B
03.36.580	ELSA 2	LRG580	B
03.36.581	ELSA 2	LRG581	B
03.36.700	ELSA 2	LRG700	B
03.36.701	ELSA 2	LRG701	B
03.36.596	D DUCO	LRG596	A
03.36.597	D DUCO	LRG597	A
03.36.598	D DUCO	LRG598	A1
03.36.599	D DUCO	LRG599	A1
03.36.726	ELSA 225	LRG726	D
03.36.727	ELSA 225	LRG727	D
03.36.728	ELSA 225	LRG728	D
03.36.729	ELSA 225	LRG729	D
03.36.730	ELSA 225	LRG730	D
03.36.731	ELSA 225	LRG731	D
03.36.736	ELSA 225	LRG736	D
03.36.737	ELSA 225	LRG737	D
03.36.836	DX195	15224836 MXC4836	C
03.36.837	DX195	15224837 MXC4837	C
-	DX225	225211002K	C
-	DX225	225211001K	C
03.36.1331	ELSA 195	MCK1331	E
03.36.1332	ELSA 195	MCK1332	E
03.36.1345	ELSA 195	MCK1345	E
03.36.1346	ELSA 195	MCK1346	E
03.36.702	ELSA 195 LE	LRG702	E
03.36.703	ELSA 195 LE	LRG703	E

A



A1



B



C



D



E



CALIPERS & REPAIR KITS

EBS "NEW" Calipers - WABCO PAN 17 Type

EBS Part No	Alternative Part No	Application	Application Part No
03.17.049	40175025 40175049 40175051	MAN	81508046089
03.17.050	40175026 40175050 40175052	MAN	81508046090
03.17.064	40175064	RENAULT	5001852882
03.17.065	40175065	RENAULT	501852883
03.17.072	40175072	DAF IVECO	1403632 1440500 500328232
03.17.073	40175073	DAF IVECO	1403633 1440501 500328234 1522094

NEW



EBS "NEW" Calipers - WABCO PAN 19 Type

EBS Part No	Alternative Part No	Application	Application Part No
03.19.037	40195017 40195037	DAF SAF KOGAL	0866216 3080003320 6500701
03.19.038	40195018 40195038	DAF SAF KOGAL	0866217 3080003220 6500702
03.19.039	40195039	DENNIS	6597423
03.19.040	40195040	DENNIS	6597431
03.19.045	40195045	DAF RENAULT	1628062 5001865918
03.19.046	40195046	DAF RENAULT	1628063 5001865919

NEW



EBS "NEW" Calipers - WABCO PAN 22 Type

EBS Part No	Alternative Part No	Application	Application Part No
03.22.001	640225015R	RATIONALISED	---
03.22.002	640225016R	RATIONALISED	---
03.22.220	6402250220	SAF	3080006700
03.22.230	6402250230	SAF	3080006800
03.22.400	6402250400	SCHMITZ	1063036 1110435
03.22.410	6402250410	SCHMITZ	1063037 1110436
03.22.015	40225015 R40225015	DAF SAF	0877933 3080.0051.00
03.22.016	40225016 R40225016	DAF SAF	0877934 3080.0050.00

NEW



Calipers - BPW	
EBS Remanufactured Part No.	Alternative Part No.
R0936272110	09.362.72.11.0
R0936272120	09.362.72.12.0
R0936272131	09.362.72.13.1
R0936272141	09.362.72.14.1

Calipers - HALDEX	
EBS Remanufactured Part No.	Alternative Part No.
R3080008100	3080008100 95620C
R3080008200	3080008200 95621C
R92503	92200 / 92503
R93840	92201
R93839	92202
R94605	94605
R95620	95620
R95621	95621

Calipers - KNORR BREMSE	
EBS Remanufactured Part No.	Alternative Part No.
RK002709	K002709
RK002797	K002797
RK002798	K002798
RK002919	K002919
RK002920	K002920
RK002923	K002923
RK002924	K002924
RK002964	K002964
RK002965	K002965
RK003192	K003192
RK003193	K003193
RK003779	K003779
RK003780	K003780
RK003781	K003781
RK003782	K003782
RK003783	K003783
RK003784	K003784
RK003789	K003789
RK003790	K003790
RK003791	K003791
RK003792	K003792
RK003793	K003793
RK003794	K003794
RK003798	K003798
RK003799	K003799
RK003800	K003800
RK003803	K003803
RK003804	K003804
RK003805	K003805

Calipers - KNORR BREMSE	
EBS Remanufactured Part No.	Alternative Part No.
RK003806	K003806
RK003807	K003807
RK003808	K003808
RK003809	K003809
RK003810	K003810
RK003811	K003811
RK003812	K003812
RK003813	K003813
RK003814	K003814
RK003815	K003815
RK003816	K003816
RK003825	K003825
RK003826	K003826
RK004570	K004570
RK004571	K004571
RK004572	K004572
RK004573	K004573
RK004580	K004580
RK004581	K004581
RK005481	K005481
RK005482	K005482
RK005610	K005610
RK005611	K005611
RK009161	K040953K50
RK009162	K009162
RK012633	K012633
RK012634	K012634
RK013160	K013160
RK013161	K013161
RK013175	K013175
RK013176	K013176
RK013203	K013203
RK013204	K013204
RK016515	K016515
RK040946	K040946K50
RK040953	K040953K50
RK040954	K040954K50
RK052380	RK052380
RK052381	K052381K50

Calipers - MERITOR	
EBS Remanufactured Part No.	Alternative Part No.
RDX19551K	15224836
RDX19552K	15224837
RLRG500	LRG500
RLRG501	LRG501
RLRG506	LRG506

Calipers - MERITOR	
EBS Remanufactured Part No.	Alternative Part No.
RLRG507	LRG507
RLRG508	LRG508
RLRG509	LRG509
RLRG510	LRG510
RLRG511	LRG511
RLRG520	LRG520
RLRG521	LRG521
RLRG522	LRG522
RLRG523	LRG523
RLRG524	LRG524
RLRG525	LRG525
RLRG526	LRG526
RLRG527	LRG527
RLRG530	LRG530
RLRG531	LRG531
RLRG536	LRG536
RLRG537	LRG537
RLRG542	LRG542
RLRG543	LRG543
RLRG544	LRG544
RLRG545	LRG545
RLRG546	LRG546
RLRG547	LRG547
RLRG548	LRG548
RLRG549	LRG549
RLRG550	LRG550
RLRG551	LRG551
RLRG553	LRG553
RLRG554	LRG554
RLRG560	LRG560
RLRG561	LRG561
RLRG568	LRG568
RLRG569	LRG569
RLRG570	LRG570
RLRG571	LRG571
RLRG572	LRG572
RLRG573	LRG573
RLRG574	LRG574
RLRG575	LRG575
RLRG580	LRG580
RLRG581	LRG581
RLRG586	LRG586
RLRG587	LRG587
RLRG588	LRG588
RLRG589	LRG589
RLRG592	LRG592
RLRG593	LRG593
RLRG596	LRG596
RLRG597	LRG597

CALIPERS & REPAIR KITS

Calipers - MERITOR

EBS Remanufactured Part No.	Alternative Part No.
RLRG598	LRG598
RLRG599	LRG599
RLRG600	LRG600
RLRG601	LRG601
RLRG602	LRG602
RLRG603	LRG603
RLRG606	LRG606
RLRG607	LRG607
RLRG608	LRG608
RLRG609	LRG609
RLRG610	LRG610
RLRG611	LRG611
RLRG612	LRG612
RLRG613	LRG613
RLRG620	LRG620
RLRG621	LRG621
RLRG622	LRG622
RLRG623	LRG623
RLRG624	LRG624
RLRG625	LRG625
RLRG626	LRG626
RLRG627	LRG627
RLRG630	LRG630
RLRG631	LRG631
RLRG634	LRG634
RLRG635	LRG635
RLRG638	LRG638
RLRG639	LRG639
RLRG648	LRG648
RLRG649	LRG649
RLRG650	LRG650
RLRG651	LRG651
RLRG670	LRG670
RLRG690	LRG690
RLRG700	LRG700
RLRG701	LRG701
RLRG702	LRG702
RLRG703	LRG703
RLRG726	LRG726
RLRG727	LRG727
RLRG728	LRG728
RLRG729	LRG729
RLRG730	LRG730
RLRG731	LRG731
RLRG736	LRG736
RLRG737	LRG737
RLRG740	LRG740
RLRG741	LRG741
RLRG764	LRG764
RLRG765	LRG765

Calipers - WABCO

EBS Remanufactured Part No.	Alternative Part No.
R40100001	40100001
R40100002	40100002
R40160015	40160015
R40160016	40160016
R40175049	40175049
R40175050	40175050
R40175062	40175062
R40175063	40175063
R40175064	40175064
R40175065	40175065
R40175072	40175072
R40175073	40175073
R40195011	40195011
R40195012	40195012
R40195021	40195021
R40195022	40195022
R40195037	40195037
R40195038	40195038
R40195039	40195039
R40195040	40195040
R40195045	40195045
R40195046	40195046
R40225003	40225003
R40225004	40225004
R40225015	40225015
R40225016	40225016
R40225025	40225025
R40225026	40225026
R40456033	40456033
R40456034	40456034
R40465019	40465019
R40465020	40465020
R42532300	42532300
R42532301	42532301
R42532302	42532302 / 42534117
R42532303	42532303 / 42534118
R42532304	42532304 / 42534119
R42532305	42532305
R42533002	42533002 / 42534121
R42533004	42533004 / 42534122
R42559201	42559201 / 504234189
R42559202	42559202 / 504234190

Calipers - WABCO MAXX 22

EBS Part No.	Alternative Part No.	Application
03.22.031	6403220310	
03.22.032	6403220320	
03.22.034	6403220340	
03.22.035	6403220350	



Carriers - HALDEX		
EBS Remanufactured Part No.	Alternative Part No.	Application
ECKH.1.21	---	MODUL T
ECKH.2.21	---	DB22 MODUL X

Carriers - KNORR BREMSE		
EBS Remanufactured Part No.	Alternative Part No.	Application
RK000026	K000026	SB7 & SN7
RK000027	K000027	SB7 & SN7
RK001105	K001105	SB6 & SN6
RK001275	K001275	SN7
RK001494	K001494	SB6
RK001505	K001505	SB7
RK001507	K001507	SB7 & SN7
RK001510	K001510	SB7 & SN7
RK001531	K001531	SB7 & SN7
RK001916	K001916	SB7 & SN7
RK001927	K001927	SB5 & SN5
RK010765	K010765	SB7 & SN7
RK011479	K011479	SB7 & SN7
RK012619	K012619	SK7
RK013672	K013672	SB6 & SN6
RK015308	K015308	SK7
---	K017864	SN7

Carriers - KNORR BREMSE		
EBS Part No.	Alternative Part No.	Application
ECKK.6.47	K000027	SB7
ECKK.6.20	K001927	SN5
ECKK.6.21	K005606	SN5
ECKK.6.31	K004679	SN6
ECKK.6.40	K052379K50	SL7
ECKK.6.41	K046498K50	SM7
ECKK.6.42	K012619	SK7
ECKK.6.43	K001520	SB7
ECKK.6.44	K001529	SB7
ECKK.6.45	K001530	SB7
ECKK.6.46	K011479	SN7

Carriers - MERITOR		
EBS Remanufactured Part No.	Alternative Part No.	Application
ECKM.6.20	-	LRG626/627
ECKM.7.20	-	ELSA 2
ECKM.7.31	MCK1319	LRG730/LRG731
ECKM.7.32	MCK1252	LRG702 / LRG703
ECKM.7.38	MCK1138	MAN
ECKM.21	-	DX195
ECKM.44.20	-	LRG726 LRG727 LRG728 LRG729 LRG736 LRG737
ECKM.44.32	MCK1384	ELSA 225

Carrier KNORR BREMSE



Carrier WABCO



Cassette MERITOR



Carriers - WABCO MAXX22		
EBS Remanufactured Part No.	Alternative Part No.	Application
ECKW.10000	6409157424	MERCEDES
ECKW.10001	6409157434	MERCEDES
ECKW.10002	6403220980	MERCEDES
ECKW.10003	6403220990	MERCEDES

Carriers - WABCO PAN19		
EBS Remanufactured Part No.	Alternative Part No.	Application
ECKW.19.45	40195045	DAF
ECKW.19.46	40195046	DAF
ECKW.19.47	6401950720	SAF
ECKW.19.48	6401950710	SAF
ECKW.19.49	4019038	SAF
ECKW.19.50	4019037	SAF
ECKW.19.51	6401950850	SCHMITZ
ECKW.19.52	6401950860	SCHMITZ

Carriers - WABCO PAN22		
EBS Remanufactured Part No.	Alternative Part No.	Application
ECKW.6.20	6402250400	SCHMITZ
ECKW.6.21	6402250410	SCHMITZ

Cassettes - MERITOR		
EBS Remanufactured Part No.	Alternative Part No.	Application
RMCK1300	MCK1300	LRG669
RMCK1301	MCK1301	LRG670
RMCK1331	MCK1331	LRG702
RMCK1332	MCK1332	LRG703
RMCK1345	MCK1345	LRG572
RMCK1346	MCK1346	LRG573
RMCK1376	MCK1376	LRG726
RMCK1377	MCK1377	LRG727
RMCK1385	MCK1385	LRG728
RMCK1386	MCK1386	LRG729

CALIPERS & REPAIR KITS

EBS REPAIR KITS FOR BPW

EBS BPW - Guide Pin & Seal Kits		
EBS Part No	Description	Image
ECKB.1	Guide Pin & Seal Kit	
ECKB.13.1	Guide Pin & Bush Kit	
ECKB.13.2	Guide Seal Kit	

EBS BPW - Adjuster Mechanism Kits		
EBS Part No	Description	Image
ECKB.3	Adjusting Mechanism & Cover	
ECKB.3.1	Adjusting Mechanism	
ECKB.3.3	Adjuster Washer	
ECKB.4	Tappet & Boot	
ECKB.5	Adjusting Screw	
ECKB.5.1	Adjusting Bush	
ECKB.15.2	Adjusting Mechanism Washer Kit	

EBS BPW - Adjuster Mechanism Kit		
EBS Part No	Description	Image
ECKB.20	Complete Adjusting Mechanism & Guide Pin Kit	

EBS BPW - Bridge Assembly Kits		
EBS Part No	Description	Image
ECKB.17	Bridge Assembly	

EBS BPW - Bearing Kits		
EBS Part No	Description	Image
ECKB.15	Bearing Set	
ECKB.15.1	Bearing Set	
ECKB.15.3	Bearing Set	

EBS BPW - Covers		
EBS Part No	Description	Image
ECKB.11	Cover Set	

EBS BPW - Operating Lever Kits		
EBS Part No	Description	Image
ECKB.18	Lever & Pin Kit	
ECKB.18.B	Lever Bush Kit	

EBS BPW - Pad Retainer Kit		
EBS Part No	Description	Image
ECKB.7.12	Pad Retainer	

EBS REPAIR KITS FOR BREMBO

EBS Part No	Description	Image
ECKBR.11	To Suit: 42532300 42532301 42532302 42532303 42532304 42532305 42533002 42533004	
ECKBR.114	BREMBO BEARING PK X 5	

The Seals and Rings supplied in this kit are made from a high quality EPDM rubber.

EBS BREMBO - Guide Pins & Bolts

EBS Part No	Description	Image
ECKBR.1.2PK	90 MM GUIDE PIN & BOLT KIT	
ECKBR.1.3PK	98 MM GUIDE PIN & BOLT KIT	
ECKS.017	SHAFT GROOVE CLIP	
ECKS.022	GUIDE PIN To Suit New Type	
ECKS.023	GUIDE PIN BOLT Fits With ECKS.022	

EBS Part No	Description	Image
ECKS.018	CAM To Suit Old & New Type	

EBS BREMBO - Pistons

EBS Part No	Description	Image
ECKS.025	HOLLOW PISTON To Suit Old Type	
ECKS.026	LONG PISTON To Suit New Type	
ECKS.027	HANDBRAKE PISTON To Suit Old Type	
ECKS.028	HANDBRAKE PISTON (Long) To Suit New Type	

EBS BREMBO - Adjusters

EBS Part No	Description	Image
ECKS.029	ADJUSTER To Suit New Type	
ECKS.037	ADJUSTER	

CALIPERS & REPAIR KITS

EBS REPAIR KITS FOR

LUCAS, GIRLING, MERITOR & PERROT

EBS GIRLING - Seal Kits

EBS Part No	Description	Image
ECKG.1.1*	To Fit: LRG510/ LRG511 LRG520/ LRG521 LRG624/ LRG625 LRG626/ LRG627	
ECKG.1.2	To Fit: LRG600 LRG601	
ECKG.2	To Fit: LRG626 LRG627	85mm 85mm 20 x 71mm 20 x 71mm

EBS PERROT - Seal Kits

EBS Part No	Application	Image
ECKP.1.1*	40456033 40456034 DAF 45 - 7.5t	
	SEAL KIT	

EBS GIRLING - Pistons

EBS Part No	Description	Image
ECKS.002	60mm Hand Brake Piston	
ECKS.003	60mm Hollow Piston	
ECKS.004	Adjuster	

EBS MERITOR - Bushes, Caps, Screws & Seals

EBS Part No	Application	Image
ECKM.6.3	LRG626 LRG627 (17" Wheels) GUIDE RUBBERS & SEALS	
ECKM.16.1	LRG510 LRG511 LRG516 LRG517 LRG520 LRG521 LRG566 LRG567	

EBS MERITOR - 17.5" WHEELS -Retainers & Fixings

EBS Part No	Application	Image
ECKM.6.20	(17.5" Wheels) CARRIER FOR LRG626 LRG627	

*The Seals and Rings supplied in this kit are made from a high quality EPDM rubber.

EBS REPAIR KITS FOR HALDEX

EBS HALDEX - Guide Pin & Seal Kits

EBS Part No	Application	Image
ECKH.1	ModulT	<p>35 x 119 mm 35 x 86 mm 80 mm</p>
ECKH.1.2	ModulT	
ECKH.1.3	ModulT	
ECKH.1.4	ModulT	
ECKH.1.6	ModulT	
ECKH.1.7	ModulT	
ECKH.1.8	ModulT	

EBS HALDEX - Guide Pin & Seal Kits

EBS Part No	Application	Image
ECKH.1.9	ModulT	
ECKH.1.10	ModulX	
ECKH.1.11	ModulX	
ECKH.1.12	ModulT	
ECKH.1.14	ModulT	
ECKH.1.14.1	ModulT	
ECKH.1.14.2	ModulT	

CALIPERS & REPAIR KITS

EBS HALDEX - Bridge Assembly Kits

EBS Part No	Application	Image
ECKH.1.17	ModulT	

EBS HALDEX - Brake Pad Retainer

EBS Part No	Application	Image
ECKH.2.12	ModulX Pad Retainer	

EBS HALDEX - Carrier

EBS Part No	Application	Image
ECKH.1.21	ModulT	

EBS HALDEX - Spring & Seal Kit

EBS Part No	Application	Image
ECKH.3	ModulX	

EBS HALDEX - Guide Pin & Seal Kits

EBS Part No	Application	Image
ECKH.2	ModulX	
ECKH.2.1	ModulX	

EBS HALDEX - Caps & Covers

EBS Part No	Application	Image
ECKH.5	ModulX Mechanism Plate	
ECKH.5.1	ModulX Cover Plate	
ECKH.7	ModulX Caps	

EBS HALDEX - Adjuster & Mechanism Kits



ECKH.4	ECKH.6	ECKH.8	ECKH.9	ECKH.9.1
ModulX Adjuster Shaft Set	ModulX Tappet Bolt	ModulX Manual Adjusting Gear	ModulX	ModulX
ECKH.17.2	ECKH.19			
ModulX	ModulX			

EBS HALDEX - Shaft Housing

EBS Part No	Application	Image
ECKH.115	ModulT Mechanism Housing	

EBS Part No	Application	Image
ECKH.17	ModulX Shaft Housing	

EBS HALDEX - Bearings

EBS Part No	Application	Image
ECKH.14	ModulX Roller Bearings	
ECKH.14.1	ModulX Roller Bearings	

EBS HALDEX - Lever

EBS Part No	Application	Image
ECKH.18	ModulX Lever	
ECKH.118	ModulT	

EBS HALDEX - Thrust Plate

EBS Part No	Application	Image
ECKH.12	ModulX Thrust plate kit	

CALIPERS & REPAIR KITS

EBS REPAIR KITS FOR

KNORR BREMSE



EBS KNORR BREMSE - Guide Pin & Seal Kits

<p>ECKK.1</p> <p>36 x 145 mm 34 x 80 mm 150 mm 85 mm</p>	<p>ECKK.1.1</p>	<p>ECKK.1.2</p> <p>36x145 mm 80 mm 32x80 mm 150 mm</p>	<p>ECKK.1.6</p> <p>36 x 114 mm 34 x 80 mm 86 mm</p>
<p>Application SB5 / SB6 / SB7</p>	<p>Application SB5 / SB6 / SB7</p>	<p>Application SB7</p>	<p>Application SB6 / SB7</p>
<p>ECKK.3.E</p> <p>35 mm 36 x 114 32 x 80 39 x 73 80 mm 85 mm 39 x 55</p>	<p>ECKK.6.1</p> <p>36 x 114 mm 32 x 80 mm 85 mm 80 mm</p>	<p>ECKK.6.1A</p> <p>36x103 mm 32x80 mm 40x36x71 mm M16x1,5x86 mm M16x1,5x80 mm</p>	<p>ECKK.6.2C</p> <p>36x114 mm 36x64 mm 86 mm 70 mm</p>
<p>Application SB5 / SB6 / SB7 SN5 / SN6 / SN7</p>	<p>Application SB5 / SB6 / SB7 SN5 / SN6 / SN7</p>	<p>Application SN6</p>	<p>Application SW6 / SW7 SK7 / ST7</p>
<p>ECKK.6.3</p> <p>30 x 72 mm 30 x 100mm 105 mm 75 mm</p>	<p>ECKK.6.4</p> <p>32x84 mm 36 x 114 mm 86 mm 80 mm</p>	<p>ECKK.7.D</p> <p>36 x 64 mm 70 mm 36 x 114 mm 85 mm</p>	<p>ECKK.8.1</p> <p>SIMPLIFIED KIT</p> <p>35 x 39 mm EKS.32 x 80 36 x 114 mm 85 mm 80 mm</p>
<p>Application SN5</p>	<p>Application SN7 SB7</p>	<p>Application SK7</p>	<p>Application SB5 / SB6 / SB7 SN6 / SN7</p>

EBS KNORR BREMSE - Covers, Guide Pin & Seal Kits

ECKK.131.1	
GUIDE PIN & BOLT	
	
Application	131776 / 131777
Alternative	381.391

ECKK.131.2	
GAITERS & COVERS	
	
Application	131776 / 131777
Alternative	381.413

ECKK.3.3	
CAPS	
	
Application	SB6 / SK7
	SN6 / SN7

EBS KNORR BREMSE - Covers, Caps & Seal Kits

ECKK.3.4	
SEALING PLUG	
	
Application	SN7

ECKK.3.5	
CAPS	
	
Application	SB7 / SN6 / SN7

ECKK.3.6	
CAP & BOOT	
	
Application	SN7

ECKK.3.7	
SB RED HALF MOON RUBBER	
	
Application	SB ALL MODELS

ECKK.5	
BOOTS & CAPS	
	
Application	SB5 / SB6 / SB7

ECKK.7	
ADJUSTER CAPS	
	
Application	SB5 / SB6 / SB7
	SN5 / SN6 / SN7

ECKK.7.1	
35mm CAPS	
	
Application	SK7
Alternative	K003902

ECKK.10.79	
DUST SEAL	
 42 mm	
Application	SK7

ECKK.10.80	
DUST SEAL	
 45 mm	
Application	SK7

ECKK.22	
 TTTT TTTT	
Application	SN7

ECKK.22.1	
 TTTTTTT TTTT	
Application	SN7

ECKK.22.5	
 TTTTTTT	
Application	SN5

CALIPERS & REPAIR KITS

EBS KNORR BREMSE - Tappets & Boots Kits

EBS Part No	Application		Image
ECKK.4 White Seal Dia = 75mm	SB5 SB6 SB7		
ECKK.4.2 White Seal Dia = 70mm	SK7	SN6 SN7	
ECKK.4.3		SN5	
ECKK.4.4	SM7 ST7	SL7	

EBS KNORR BREMSE - Guide Sleeve Kits

EBS Part No	Application		Image
ECKK.13.2C	SB5 SB6 SB7	SN6 SN7	 39mm 35mm 32 x 80 mm
ECKK.13.4C	SB5 SB6 SB7	SN6 SN7	 80mm 35mm 39mm 32 x 80 mm
ECKK.13.6C		SN6 SN7	 35mm 39mm
ECKK.13.7C	SB6 SB7 SN6 SN7		

EBS KNORR BREMSE - Bolts, Screws & Nut Kits

EBS Part No	Application		Image
ECKK.2.8 (Pack Qty 10)	SB5 SB6 SB7	SN5 SN6 SN7	
ECKK.18.5	SB5 SB6 SB7	SK5 SK6	 60 mm 55 mm 45 mm

EBS KNORR BREMSE - Guide & Bush Kits

EBS Part No	Application		Image
ECKK.13.3	SB5 SB6 SB7		 34 x 80 mm
ECKK.13.3B	SB5 SB6 SB7		 85 mm 34 x 80 mm

EBS KNORR BREMSE - Adjuster Mechanism Kits

EKS.3100.K1 ADJUSTING MECHANISM (Hex Head)	EKS.3100.K2 ADJUSTING MECHANISM	EKS.3100.K3	ECKK.10.1 PIGNON SHAFT
Application SB6 / SB7 SN6 / SN7	Application SB5	Application SL & SM7	Application SB6 / SB7 SN6 / SN7
ECKK.10.2 PIGNON SHAFT	ECKK.10.3 ADJUSTING MECHANISM (Starr Head)	ECKK.10.4 ADJUSTING MECHANISM (Square Head)	ECKK.10.5 ADJUSTING MECHANISM
Application SK7	Application SB6 / SB7 SN6 / SN7	Application SB6 / SB7 SN6 / SN7	Application SB5

EBS KNORR BREMSE - Adjuster Mechanism Kits

ECKK.10.7 PIGNON SHAFT 		ECKK.10.8 PIGNON SHAFT (PACK OF 5) 		ECKK.10.9 PIGNON SHAFT. PACK OF 5 		ECKK.11 CHAIN 	
Application	SL & SM7	Application	SB5	Application	SN5	Application	SB6/SB7/SL7/SM7 SN6 / SN7
ECKK.11.1 GEAR WHEEL (PACK OF 5) 		ECKK.12 CHAIN 14 LINKS 		ECKK.12.1 CHAIN 12 LINKS 			
Application	SB5 / SB6 / SB7 SN5 / SN6 / SN7	Application	SN5	Application	SB5		

EBS KNORR BREMSE - Bridge Assembly

ECKK.17 		ECKK.17.1 		ECKK.17.2 		ECKK.17.B BRIDGE SCREW 	
Application	SB6 / SB7	Application	SN6 / SN7	Application	SK7 SN6 / SN7	To Suit	ECKK.17, ECKK.17.1 & ECKK.17.2

EBS KNORR BREMSE - Bridge Assembly

EBS Part No	Application	Image
ECKK.17.3	SL7 SM7	
	BRIDGE KIT	
ECKK.17.4	SN5	
	BRIDGE KIT	
ECKK.17.C	SL7 -	
	BRIDGE SCREW	
ECKK.17.P	SB5 SN6 SB6 SN7 SB7	
	BRIDGE PIN KIT	

EBS KNORR BREMSE - Overhaul Kits

ECKK.8 	
Application	SB5 / SB6 / SB7

CALIPERS & REPAIR KITS

EBS KNORR BREMSE - Bearing Kits

EBS Part No	Application	Image	EBS Part No	Application	Image	
ECKK.14	SB6 SB7		ECKK.14.2	SB5	SN5	
ECKK.14.1	---	SN6 SN7	ECKK.14.3	SL7	SM7	

EBS KNORR BREMSE - Operating Lever Kits

<p>ECKK.15</p> <p>(PACK OF 5)</p>		<p>ECKK.18</p>		<p>ECKK.18.1</p>		<p>ECKK.18.2</p>	
Application	Lever Repair Kit To Suit All Levers Below	Application	SB7 MINUS 12°	Application	SB7 0°	Application	SN7 MINUS 12°
<p>ECKK.18.3</p>		<p>ECKK.18.4</p>		<p>ECKK.18.6</p> <p>WITHOUT ROLLER</p>		<p>ECKK.18.7</p>	
Application	SN7 0°	Application	SB6 0°	Application	SN6 / SK7 0° / 0°	Application	SL7 / SM7 ---
<p>ECKK.18.8</p>		<p>ECKK.18.9</p>		<p>ECKK.18.10</p>		<p>ECKK.18.11</p>	
Application	SN5	Application	SB6	Application	SB6	Application	SN7 0° / 0°
<p>ECKK.18.12</p>		<p>ECKK.18.13</p> <p>WITH ROLLER</p>					
Application	ST7	Application	SN6 & SK7				

EBS KNORR BREMSE - Flange Assembly

JYEC.0001	
	
Application	SB7 For K003799 LEFT HAND MINUS 12°

JYEC.0002	
	
Application	SB7 For K003800 RIGHT HAND MINUS 12°

JYEC.0001/1	
	
Application	SN7 For K003815 LEFT HAND PLUS 8°

JYEC.0002/1	
	
Application	SN7 For K003816 RIGHT HAND PLUS 8°

JYEC.0001/FB	
	
Application	SB7 LEFT HAND FLAT BACK

JYEC.0002/FB	
	
Application	SB7 RIGHT HAND FLAT BACK

EBS KNORR BREMSE - Sensor Housing Kits

ECKK.16	
	
Description	METAL SCREW TYPE HOUSING FOR SB6/SB7

ECKK.16-PT	
	
Description	METAL SCREW TYPE HOUSING C/W 3 WIRE SENSOR FOR SB6

ECKK.16.1.R	
	
Description	PLASTIC CLIP TYPE HOUSING FOR SB7 & SN7

ECKK.16.1.R-PT	
	
Description	PLASTIC CLIP TYPE HOUSING C/W 3 WIRE SENSOR FOR SB7 & SN7

ECKK.16.1.R-PT/1	
	
Description	PLASTIC CLIP TYPE HOUSING C/W 2 WIRE SENSOR FOR SB7 & SN7

ECKK.16.2	
	
Description	PLASTIC SCREW TYPE HOUSING SB6-SB7-SN6-SN7

ECKK.16.2-PT	
	
Description	PLASTIC SCREW TYPE HOUSING C/W 3 WIRE SENSOR FOR SB6-SB7-SN6-SN7

ECKK.16.2-PT/1	
	
Description	PLASTIC SCREW TYPE HOUSING C/W 3 WIRE SENSOR FOR MAN SB6-SB7-SN6-SN7

EBS KNORR BREMSE - Sensor Housing Kits

<p>ECKK.16.2-PT/2</p> 		<p>ECKK.16.3</p> 		<p>ECKK.16.4-PT</p> 		<p>ECKK.16.5</p> 	
Description	PLASTIC SCREW TYPE HOUSING C/W 2 WIRE SENSOR	Description	SK7	Description	PLASTIC CLIP AND SCREW TYPE HOUSING	Description	PLASTIC CLIP TYPE HOUSING FOR SB5
<p>ECKK.16.5-PT</p> 		<p>ECKK.16.6</p> 		<p>ECKK.16.6.1</p> 		<p>ECKK.16.6.1-PT/1</p> 	
Description	PLASTIC CLIP TYPE HOUSING C/W 2 WIRE SENSOR FOR SB5	Description	PLASTIC HOUSING SCREW TYPE SB7 RADIAL	Description	PLASTIC HOUSING CLIP TYPE FOR SB7 RADIAL	Description	PLASTIC HOUSING CLIP TYPE 3 WIRE SENSOR FOR SB7 RADIAL
<p>ECKK.16.6-PT</p> 		<p>ECKK.16.6-PT/1</p> 		<p>ECKK.16.7</p> 		<p>ECKK.16.7-PT</p> 	
Description	PLASTIC SCREW TYPE HOUSING C/W 3 WIRE SENSOR FOR SB7000	Description	COVER & SENSOR FOR 3 WIRE MAN TYPE	Description	PLASTIC SCREW TYPE HOUSING FOR SN5	Description	PLASTIC SCREW TYPE HOUSING C/W 2 WIRE SENSOR FOR SN5
<p>ECKK.16.7-PT/1</p> 							
Description	PLASTIC SCREW TYPE HOUSING C/W 3 WIRE SENSOR FOR MAN (SN5)						

EBS KNORR BREMSE - Potentiometers

<p>EBSK.9031 REPAIR KIT</p>  <p>INCLUDES PLASTIC COVER COGS & 3PIN PLUG</p>	<p>EBS.9031.0T</p>  <p>POTENTIOMETER TESTER</p>	<p>EBS.9031.ADP</p>  <p>POTENTIOMETER ADAPTOR</p>	
<p>EBS.9031</p>  <p>POTENTIOMETER REPAIR KIT</p>	<p>EBS.9031.1</p>  <p>2 WIRE SENSOR C/W LOCATING TABS FOR DAF/MERCEDES</p>	<p>EBS.9031.2</p>  <p>3 WIRE SENSOR STANDARD OLD TYPE</p>	<p>EBS.9031.3</p>  <p>3 WIRE SENSOR C/W LOCATING TABS</p>
<p>EBS.9031.3.A</p>  <p>FOR MAN</p> <p>3 WIRE SENSOR C/W LOCATING TABS</p>	<p>JY.9031.3</p>  <p>GEAR PIN</p>	<p>EBS.9031.G2</p>  <p>5 MM</p> <p>GEAR PIN</p>	<p>EBS.9031.G3</p>  <p>9 MM</p> <p>GEAR PIN</p>
<p>EBS.9031.G4</p>  <p>5MM</p> <p>SB POTENTIOMETER GEAR KIT</p>	<p>EBS.9031.G5</p>  <p>9 MM</p> <p>SB POTENTIOMETER GEAR KIT</p>		

EBS KNORR BREMSE - Brake Pad, Retainers & Fixings

<p>ECKK.2.5</p>  <table border="1"> <tr> <td>Application</td> <td>SB5/ SB6/ SB7 SN5/ SN6/ SN7</td> </tr> </table>	Application	SB5/ SB6/ SB7 SN5/ SN6/ SN7	<p>ECKK.2.5.1</p>  <table border="1"> <tr> <td>Application</td> <td>SK5/ SK6</td> </tr> </table>	Application	SK5/ SK6	<p>ECKK.2.7</p>  <table border="1"> <tr> <td>Application</td> <td>SB5/ SB6/ SB7 SN5/ SN6/ SN7</td> </tr> </table>	Application	SB5/ SB6/ SB7 SN5/ SN6/ SN7	<p>ECKK.7.12</p>  <table border="1"> <tr> <td>Application</td> <td>SK7</td> </tr> </table>	Application	SK7	<p>ECKK.131.3</p>  <table border="1"> <tr> <td>Application</td> <td>131776 / 131777</td> </tr> <tr> <td>Alternative</td> <td>381.419</td> </tr> </table>	Application	131776 / 131777	Alternative	381.419
Application	SB5/ SB6/ SB7 SN5/ SN6/ SN7															
Application	SK5/ SK6															
Application	SB5/ SB6/ SB7 SN5/ SN6/ SN7															
Application	SK7															
Application	131776 / 131777															
Alternative	381.419															

EBS KNORR BREMSE - Caliper Repair Tools

<p>ECKK.21</p> 	<p>ECKK.21.1</p> 	<p>ECKK.21.2</p> 
---	---	---

CALIPERS & REPAIR KITS

EBS REPAIR KITS FOR MERITOR D3

LRG524 LRG529 LRG622
 LRG525 LRG532 LRG623
 LRG526 LRG533
 LRG527 LRG562
 LRG528 LRG563

EBS MERITOR D3 - Guide Pin & Seal Kits

EBS Part No	Application	Image
ECKM.1	D3	
	SJ4001 SJ4011 SJ4012	

EBS MERITOR D3 - Bushes, Caps, Screws & Seals

EBS Part No	Application	Image
ECKM.24.9	D3	

EBS MERITOR D3 - Adjusting Mechanism & Spares

EBS Part No	Application	Image
ECKM.24.4	D3	
	ADJUSTER TAPPET LEFT HAND	
ECKM.25.4	D3	
	ADJUSTER TAPPET RIGHT HAND	

EBS MERITOR D3 - Covers

EBS Part No	Application	Image
ECKM.6	D3	
	COVER & BOOT	
ECKM.24.8	D3	
	COVER	

EBS MERITOR D3 - Clutch & Gear Mechanism & Spares

ECKM.24.2		ECKM.24.6		ECKM.24.7		ECKM.24.C	
							
Application	D3 THURST BALL BEARING	Application	D3 WAVY WASHER	Application	D3 SHAFT ROLLER BEARING	Application	D3
						Comprises of:	ECKM.24.2 ECKM.24.6 ECKM.24.7

EBS MERITOR D3 - Clutch & Gear Mechanism & Spares

EBS Part No	Application	Image
ECKM.24	D3 SHAFT LEFT HAND 48 TEETH	
ECKM.24.1	D3 SHAFT SUPPORT LEFT HAND	
ECKM.24.3	D3 CLUTCH SYSTEM LEFT HAND	
ECKM.24.5	D3 SMALL CLUTCH SYSTEM LEFT HAND	
ECKM.25	D3 SHAFT RIGHT HAND 48 TEETH	
ECKM.25.1	D3 SHAFT SUPPORT RIGHT HAND	
ECKM.25.3	D3 CLUTCH SYSTEM RIGHT HAND	

CALIPERS & REPAIR KITS

EBS MERITOR D3 - Clutch & Gear Mechanism & Spares

EBS Part No	Application		Image
ECKM.24.11	D3	PUSH PLATE	
ECKM.25.5	D3	SMALL CLUTCH SYSTEM RIGHT HAND	
ECKM.27	D3	SHAFT LEFT HAND 26 TEETH	
ECKM.27.1	D3	SHAFT RIGHT HAND 26 TEETH	
ECKM.28	D3	SHAFT LEFT HAND 26 TEETH	
ECKM.29	D3	SHAFT RIGHT HAND 26 TEETH	

EBS MERITOR D3 - Pad Retainer

ECKM.24.12	
	
Application	D3 PAD RETAINER

EBS REPAIR KITS FOR

MERITOR DX195

15224836

15224837

MXC4836

MXC4837

EBS MERITOR DX195 - Guide Pin & Seal Kits

EBS Part No	Application	Image
ECKM.8	DX195	<p>31.97 x 97 mm 32 x 97 mm</p>
	MCK1169 MCK1171 MCK1268	<p>80 mm 55 mm</p>

EBS MERITOR DX195- Guide Pins & Bolts

EBS Part No	Application	Image
ECKM.8.G	DX195	<p>37 x 97 mm 80 mm 55 mm</p>

EBS MERITOR DX195- Bushes, Caps, Screws & Seals

EBS Part No	Application	Image
ECKM.2.C	DX195	
	CAPS (Pack Qty 10)	
ECKM.2.S	DX195	
	CAPS (Pack Qty 10)	
ECKM.2.1	DX195 BOOTS CAPS & SCREWS	

EBS MERITOR DX195 - Operating Levers & Spares

EBS Part No	Application	Image
ECKM.21.1	DX195	<p>80 mm</p>
	OPERATING LEVER	

EBS MERITOR DX225 - Operating Levers & Spares

EBS Part No	Application	Image
ECKM.21.2	DX225	<p>90 mm</p>
	OPERATING LEVER	

EBS MERITOR DX195 - Bearings, Cams & Spares

EBS Part No	Application	Image
ECKM.2	DX195	
	CAM KIT	
ECKM.2.B	DX195	
	ROLLER BEARING (LIGHT)	
ECKM.2.D	DX195	
	ROLLER BEARING (COMPLETE)	
ECKM.2.GR	DX195	
	CAM	

CALIPERS & REPAIR KITS

EBS MERITOR DX195 - Adjusting Mechanism & Spares

ECKM.2.E	
Application	DX195 ADJUSTING MECHANISM FOR 15224837

ECKM.2.F	
Application	DX195 ADJUSTING MECHANISM FOR 15224836

ECKM.2.36	
Application	DX195 ADJUSTING MECHANISM FOR 15224836

ECKM.2.37	
Application	DX195 ADJUSTING MECHANISM FOR 15224836

ECKM.19	
Application	DX195 BRIDGE & TUBES FOR 15224837

ECKM.19.1	
Application	DX195 BRIDGE & INNER RING

ECKM.19.2	
Application	DX195 PISTONS & PIGNONS FOR 15224837

ECKM.19.3	
Application	DX195 CENTRAL FORK & PIGNON

ECKM.20	
Application	DX195 BRIDGE & TUBES FOR 15224836

ECKM.19.92	
Application	DX195 15224836

ECKM.19.93	
Application	DX195 15224837

ECKM.20.2	
Application	DX195 PISTONS & PIGNONS FOR 15224836

EBS MERITOR DX195 - Retainers & Fixings

ECKM.2.H	
	
Application	DX195 PAD RETAINER

ECKM.2.J	
	
Application	DX195 BRACKET SEAL & PIN

ECKM.2.K	
	
Application	DX195 PAD RETAINER KIT

ECKM.2.PL	
	
Application	DX195 MOUNTING BRACKET FOR 15224836

ECKM.2.PR	
	
Application	DX195 MOUNTING BRACKET FOR 15224837

ECKM.9.1	
	
Application	DX195 PAD PUSH PLATE FOR 15224836

ECKM.9.2	
	
Application	DX195 PAD PUSH PLATE FOR 15224837

ECKM.21	
	
Application	DX195 CARRIER FOR 15224836 & 15224837

EBS REPAIR KITS FOR MERITOR DUCO (ALL MODELS)

LRG536 LRG561 LRG598 LRG651
 LRG537 LRG578 LRG599 LRG652
 LRG552 LRG579 LRG648 LRG653
 LRG553 LRG596 LRG649
 LRG560 LRG597 LRG650

EBS MERITOR DUCO (All Models) Guide Pin & Seal Kits

EBS Part No	Application	Image
ECKM.3.1	B DUCO C DUCO D DUCO Axial LE DUCO MCK1116 MCK1134	35 x 60 mm 35x102 mm 80 mm
ECKM.3.14	B DUCO C DUCO D DUCO D DUCO Axial LE DUCO	35 x 102 mm
ECKM.98	D DUCO Radial To Suit: LRG598 LRG599 MCK1135	124 mm 124 mm 35 x 102 mm 35 x 102 mm
ECKM.3.18	DUCO SCREWS FOR BODY FLANGE	All Are 55 mm
ECKM.7.12	D DUCO PLUG RINGS (Pack Qty 10)	

EBS MERITOR DUCO (All Models) - Adjusting Mechanism & Spares

EBS Part No	Application	Image
ECKM.3.2	C DUCO D DUCO Axial LE DUCO ADJUSTING TAPPET MECHANISM LEFT HAND	35 x 60 mm 35x102 mm 80 mm
ECKM.4.2	C DUCO D DUCO Axial D DUCO Radial LE DUCO ADJUSTING TAPPET MECHANISM RIGHT HAND	35 x 60 mm 35x102 mm 80 mm
ECKM.3.5	B DUCO C DUCO D DUCO Axial D DUCO Radial LE DUCO TAPPET HEAD	124 mm 124 mm 35 x 102 mm 35 x 102 mm
ECKM.3.16	C DUCO D DUCO Axial LE DUCO AUTOMATIC ADJUSTER ANTI CLOCKWISE	
ECKM.3.17	C DUCO D DUCO Axial D DUCO Radial LE DUCO AUTOMATIC ADJUSTER CLOCKWISE	

EBS MERITOR DUCO (All Models) - Adjusting Mechanism & Spares

EBS Part No	Application	Image
ECKM.7.11.3	B DUCO	
	ADJUSTING DEVICE LEFT HAND	
ECKM.7.11.4	B DUCO	
	ADJUSTING DEVICE RIGHT HAND	
ECKM.18	B DUCO C DUCO D DUCO	
	ADJUSTER TAPPETS COVER	

EBS MERITOR DUCO (All Models) - Retainers & Fixings

EBS Part No	Application	Image
ECKM.3.12	B DUCO C DUCO D DUCO LE DUCO	
	PAD RETAINER	
ECKM.3.13	B DUCO C DUCO D DUCO LE DUCO	
	VISUAL PAD WEAR ASSY	

EBS MERITOR DUCO (All Models) - Clutch & Gear Mechanism & Spares

ECKM.3.10	ECKM.3.11	ECKM.5.2	ECKM.5.3	ECKM.56.10
				
Application	Application	Application	Application	Application
C DUCO D DUCO	C DUCO D DUCO	C DUCO D DUCO LE DUCO	C DUCO D DUCO LE DUCO	C DUCO
INTERMEDIATE GEAR & SPRING	ANTI ROTATION PLATE	SMALL GEAR MECHANISM 6.0 X 0.8 CLOCKWISE THREAD	SMALL GEAR MECHANISM 6.0 X 0.8 ANTI CLOCKWISE THREAD	INTERMEDIATE GEAR & SPRING

EBS MERITOR DUCO (All Models) - Pad Carrier

EBS Part No	Application	Image
ECKM.3.20	To Suit LRG536/ LRG537/ LRG596/ LRG597/ LRG598/ LRG599	

CALIPERS & REPAIR KITS

EBS MERITOR DUCO (All Models) - Operating Levers & Spares

<p>ECKM.3.3/ ECKM.3.3B</p>		<p>ECKM.3.4</p>		<p>ECKM.4.4</p>		<p>ECKM.52.3</p>	
Application	<p>B DUCO C DUCO D DUCO Axial LE DUCO</p> <p>BEARINGS KIT</p>	Application	<p>D DUCO</p> <p>LEFT HAND Not for LRG598 / 599 Radial</p>	Application	<p>D DUCO</p> <p>RIGHT HAND Not for LRG598 / 599 Radial</p>	Application	<p>B DUCO</p> <p>LEFT & RIGHT HAND</p>
<p>ECKM.56.2</p>		<p>ECKM.56.3</p>		<p>ECKM.98.1</p>		<p>ECKM.98.3</p>	
Application	<p>C DUCO LE DUCO</p> <p>LEFT HAND</p>	Application	<p>C DUCO LE DUCO</p> <p>RIGHT HAND</p>	Application	<p>D DUCO</p> <p>LEFT & RIGHT HAND</p>	Application	<p>D DUCO</p> <p>BEARING KIT</p>

EBS MERITOR DUCO (All Models) - Flange Gaskets & Spares

<p>ECKM.3.7</p>		<p>ECKM.3.9</p>		<p>ECKM.56.7</p>		<p>ECKM.98.2</p>	
Application	<p>D DUCO</p>	Application	<p>B DUCO C DUCO D DUCO LE DUCO</p> <p>ADJUSTER STEM DUST CAP</p>	Application	<p>B DUCO C DUCO LE DUCO</p>	Application	<p>D DUCO</p>

EBS Repair Kits For **MERITOR** ELSA1

- | | | | |
|--------|--------|--------|--------|
| LRG590 | LRG643 | LRG570 | LRG587 |
| LRG591 | LRG704 | LRG571 | LRG588 |
| LRG616 | LRG705 | LRG574 | LRG589 |
| LRG617 | LRG752 | LRG575 | |
| LRG632 | LRG753 | LRG576 | |
| LRG633 | LRG542 | LRG577 | |
| LRG642 | LRG543 | LRG586 | |

EBS MERITOR ELSA 1 - Guide Pin & Seal Kits

EBS Part No	Application	Image
ECKM.5	ELSA 1	<p>35 x 135 mm 35 x 72 mm 90 mm 150 mm</p>
	MCK1102	
ECKM.23	ELSA 1	<p>90 mm 150 mm 35 x 135 mm 28x 110 mm</p>
	To suit: LRG574 LRG575 LRG590 LRG591 LRG704 LRG705	
MCK1103		

EBS MERITOR ELSA 1 - Adjusting Mechanism & Spares

EBS Part No	Application	Image
ECKM.5.4	ELSA 1	
	LOCKING SHIM	
ECKM.5.5	ELSA 1	
	TAPPET COVER	
ECKM.5.6	ELSA 1	
	ADJUSTING MECHANISM & TAPPETS LEFT HAND	
ECKM.5.7	ELSA 1	
	ADJUSTING MECHANISM & TAPPETS RIGHT HAND	

EBS MERITOR ELSA 1 - Bushes, Caps, Screws & Seals

EBS Part No	Application	Image
ECKM.5.13	ELSA 1	
ECKM.5.16	ELSA 1	
	BUSHES (Pack Qty 10)	

EBS MERITOR ELSA 1 - Clutch & Gear Mechanism & Spares

EBS Part No	Application	Image
ECKM.5.2	ELSA 1 SMALL GEAR MECHANISM 6.0 x 0.8 clockwise thread	
ECKM.5.3	ELSA 1 SMALL GEAR MECHANISM 6.0 x 0.8 ANTI clockwise thread	

CALIPERS & REPAIR KITS



**EBS MERITOR ELSA 1
- Clutch & Gear Mechanism & Spares**

EBS Part No	Application	Image
ECKM.5.9	ELSA 1	
	ADJUSTING MECHANISM CLUTCH SYSTEM LEFT HAND	
ECKM.5.10	ELSA 1	
	ADJUSTING MECHANISM CLUTCH SYSTEM RIGHT HAND	

EBS MERITOR ELSA 1 - Guide Pins & Bolts

EBS Part No	Application	Image
ECKM.5.17	ELSA1	<p>M14x1.5 x 90 mm</p> 
	(Pack Qty 7)	

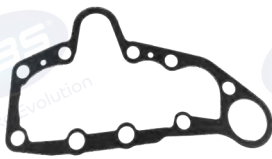
EBS MERITOR ELSA 1 - Flange Gaskets & Spares

EBS Part No	Application	Image
ECKM.5.18A	ELSA 1	
	WITH SENSOR	
ECKM.5.18B	ELSA 1	
	WITHOUT SENSOR	
ECKM.5.18C	ELSA 1	
	WITH SENSOR	

**EBS MERITOR ELSA 1
- Operating Levers & Spares**

EBS Part No	Application	Image
ECKM.3.3 ECKM.3.3B	ELSA 1	
	BEARING KIT	
ECKM.5.11	ELSA 1	
	SPRING RETAINERS THRUST LEFT HAND	
ECKM.5.12	ELSA 1	
	SPRING RETAINERS THRUST RIGHT HAND	
ECKM.5.14	ELSA 1	
	LEFT HAND	
ECKM.5.15	ELSA 1	
	RIGHT HAND	
ECKM.98.3	ELSA 1	
	BEARING KIT	

EBS MERITOR ELSA 1 - Pad Retainer

EBS Part No	Application	Image
ECKM.5.21	ELSA1	

EBS Repair Kits For **MERITOR**

ELSA195

LRG702
LRG703

ELSA225

LRG726 LRG730
LRG727 LRG731
LRG728 LRG736
LRG729 LRG737

EBS MERITOR ELSA 195 & ELSA 225 - Guide Pin & Seal Kits

ECKM.71.C

80mm 120mm
40mm 40mm
35 x 117mm 31 x 78mm

Application	ELSA 195	ELSA 225
-------------	----------	----------

ECKM.73C
Complete Adjuster & Casting

Application	ELSA 195	ELSA 225
-------------	----------	----------

ECKM.30

31 x 117 mm 35 x 117 mm
120 mm

Application	ELSA 195	ELSA 225
-------------	----------	----------

EBS MERITOR ELSA 195 & ELSA 225 - Bushes, Caps, Screws & Seals

EBS MERITOR ELSA 195 & ELSA 225 - Operating Levers & Spares

EBS Part No	Application	Image
ECKM.5.16	ELSA 195 ELSA 225	
	BUSHES (Pack Qty 10)	
ECKM.7.2	ELSA 195 ELSA 225	
	ACTUATOR SEAL	
ECKM.7.10	ELSA 195 ELSA 225	
	GAITER, CAPS & BOLTS	
ECKM.7.12	ELSA 195 ELSA 225	
	PLUG RINGS (Pack Qty 10)	

EBS Part No	Application	Image
ECKM.3.3/ ECKM.3.3B	ELSA 195 ELSA 225	
	BEARING KIT	
ECKM.7.16	ELSA 195 ELSA 225	

CALIPERS & REPAIR KITS

EBS MERITOR ELSA 195 & ELSA 225 - Adjusting Mechanism & Spares

ECKM.3.9		ECKM.7.3		ECKM.7.4		ECKM.7.6	
Application	ELSA 195 ELSA 225	Application	ELSA 195 ELSA 225	Application	ELSA 195 ELSA 225	Application	ELSA 195 ELSA 225
	ADJUSTER STEM DUST CAP		ADJUSTING MECHANISM C/W GASKET & BOLTS		ADJUSTING MECHANISM SEALING		TAPPET SYSTEM
ECKM.7.7		ECKM.7.9		ECKM.7.11.1		ECKM.7.11.2	
Application	ELSA 195 ELSA 225	Application	ELSA 195 ELSA 225	Application	ELSA 195 ELSA 225	Application	ELSA 195 ELSA 225
	TAPPETS		ADJUSTING MECHANISM CENTRAL PART		ADJUSTING DEVICE (NEW TYPE)		ADJUSTING DEVICE (OLD MODELS)
ECKM.7.18		ECKM.18		ECKM.7.21		SECKM.7.3	
Application	ELSA 195 ELSA 225	Application	ELSA 195 ELSA 225	Application	ELSA 195 ELSA 225	Application	ELSA 195 ELSA 225
	TAPPET SET		ADJUSTER TAPPETS COVER		ADJUSTER ASSY		GASKET

EBS MERITOR ELSA 195 & ELSA 225 - Clutch & Gear Mechanism & Spares

EBS Part No	Application	Image
ECKM.7.13	ELSA 195 ELSA 225	
	CLUTCH SYSTEM	

EBS MERITOR ELSA 195 & ELSA 225 - Brake Pad Retainer

EBS Part No	Application	Image
ECKM.44.12	ELSA 195 ELSA 225	
	BRAKE PAD RETAINER	

EBS MERITOR ELSA 225 - Operating Levers & Spares

EBS Part No	Application	Image
ECKM.7.29	ELSA 225 LEFT & RIGHT HAND	
	To Suit LRG726/LRG727	

EBS Part No	Application	Image
ECKM.7.30	ELSA 225	
	LEFT & RIGHT HAND	

EBS MERITOR ELSA 225 - Pad Carrier & Bridge

EBS Part No	Application	Image
ECKM.44.20	To Suit LRG726 LRG727 LRG728 LRG729 LRG736 LRG737	
ECKM.44.21 (Bridge)	To Suit LRG726 LRG727 LRG728 LRG729	

EBS MERITOR ELSA 225 - Pad Carrier & Bridge

EBS Part No	Application	Image
ECKM.44.32	ELSA 225 To Suit MCK1384	
ECKM.44.33 (Bridge)	ELSA 225 To Suit MCK1383	

EBS MERITOR ELSA 225 - Bearings, Cams & Spares

EBS Part No	Application	Image
ECKM.3.19	ELSA 195 ELSA 225	
	BEARING CAPS	

EBS MERITOR ELSA 225 - Adjusting Mechanism & Spares

EBS Part No	Application	Image
ECKM.18.1	ELSA 195 ELSA 225	
	GUIDE PIN GAITER	

EBS MERITOR ELSA 225 - Visual Pad Wear Assy

EBS Part No	Application	Image
ECKM.7.19	ELSA 225	
	Alternative	
		MCK1311

CALIPERS & REPAIR KITS

EBS Repair Kits For **MERITOR** ELSA2

- | | | | | | |
|--------|--------|--------|--------|--------|--------|
| LRG544 | LRG581 | LRG658 | LRG670 | LRG722 | LRG749 |
| LRG545 | LRG582 | LRG659 | LRG700 | LRG723 | LRG750 |
| LRG546 | LRG583 | LRG662 | LRG701 | LRG724 | LRG751 |
| LRG547 | LRG638 | LRG663 | LRG712 | LRG725 | |
| LRG572 | LRG639 | LRG664 | LRG713 | LRG744 | |
| LRG573 | LRG646 | LRG665 | LRG720 | LRG745 | |
| LRG580 | LRG647 | LRG669 | LRG721 | LRG748 | |

EBS MERITOR ELSA 2 - Guide Pin & Seal Kits

EBS Part No	Application	Image
ECKM.26	ELSA 2	<p>35 x 144 mm 31 x 84 mm 150 mm 90 mm All Are 40 mm</p>
	MCK1243	
ECKM.46	ELSA 2	<p>90 mm 33 x 67 mm 150 mm 35 x 129 mm</p>
	MCK1086	
		<p>All are 16 x 40</p>

EBS MERITOR ELSA 2 - Bushes, Caps, Screws & Seals

EBS Part No	Application	Image
ECKM.516	ELSA 2	
	BUSHES (Pack Qty 10)	
ECKM.7.2	ELSA 2	
	ACTUATOR SEAL	
ECKM.7.12	ELSA 2	
	PLUG RINGS (Pack Qty 10)	
ECKM.7.15	ELSA 2	

EBS MERITOR ELSA 2 - Bearings, Cams & Spares

EBS Part No	Application	Image
ECKM.3.19	ELSA 2	
	BEARING CAPS	

EBS MERITOR ELSA 2 - Clutch & Gear Mechanism & Spares

EBS Part No	Application	Image
ECKM.7.13	ELSA 2	
	CLUTCH SYSTEM	

EBS MERITOR ELSA 2 - Adjusting Mechanism & Spares

<p>ECKM.3.9</p> 		<p>ECKM.7.4</p> 		<p>ECKM.7.5</p> 		<p>ECKM.7.6</p> 	
Application	<p>ELSA 2</p> <p>ADJUSTER STEM DUST CAP</p>	Application	<p>ELSA 2</p> <p>ADJUSTING MECHANISM SEALING</p>	Application	<p>ELSA 2</p> <p>ADJUSTING MECHANISM C/W GASKET & BOLTS</p>	Application	<p>ELSA 2</p> <p>TAPPET SYSTEM</p>
<p>ECKM.7.5C</p> 		<p>ECKM.7.7</p> 		<p>ECKM.7.8</p> 		<p>ECKM.7.9</p> 	
Application	<p>ELSA 2</p> <p>COMPLETE ADJUSTER & CASTING</p>	Application	<p>ELSA 2</p> <p>TAPPETS</p>	Application	<p>ELSA 2</p> <p>CENTRAL RING</p>	Application	<p>ELSA 2</p> <p>ADJUSTING MECHANISM CENTRAL PART</p>
<p>ECKM.7.11.3</p> 		<p>ECKM.7.11.4</p> 		<p>ECKM.7.18</p> 		<p>ECKM.7.21</p> 	
Application	<p>ELSA 2</p> <p>ADJUSTING DEVICE LEFT HAND</p>	Application	<p>ELSA 2</p> <p>ADJUSTING DEVICE RIGHT HAND</p>	Application	<p>ELSA 2</p> <p>TAPPET SET</p>	Application	<p>ELSA 2</p> <p>ADJUSTER ASSY</p>
<p>ECKM.7.76 (Pack of 2)</p> 		<p>ECKM.18</p> 		<p>ECKM.18.1</p> 		<p>SECKM.7.5</p> 	
Application	<p>ELSA 2</p> <p>TAPPET SYSTEM</p>	Application	<p>ELSA 2</p> <p>ADJUSTER TAPPETS COVER</p>	Application	<p>ELSA 2</p> <p>GUIDE PIN GAITER</p>	Application	<p>ELSA 2</p> <p>RUBBER GASKET</p>

CALIPERS & REPAIR KITS

EBS MERITOR ELSA 2 - Operating Levers & Spares

ECKM.3.3/ ECKM.3.3B		ECKM.714		ECKM.714.2		ECKM.98.3	
Application	ELSA 2 BEARING KIT	Application	ELSA 2 LEFT & RIGHT HAND	Application	ELSA 2 OPERATION LEVER (Radial)	Application	ELSA 2 BEARING KIT

EBS MERITOR ELSA 2- Retainers & Fixings

EBS Part No	Application	Image
ECKM.8.13	ELSA 2	
	VISUAL PAD WEAR ASSY	
ECKM.7.20	ELSA 2	
	CARRIER	

EBS MERITOR ELSA 2 - Brake Pad Retainer

EBS Part No	Application	Image
ECKM.44.12	ELSA 2	
	BRAKE PAD RETAINER	

EBS Repair Kits For **MERITOR** **LISA** (All Models)

LRG548 LRG564 LRG595
LRG549 LRG565 LRG630
LRG550 LRG591 LRG631
LRG551 LRG592
LRG554 LRG593
LRG555 LRG594

EBS MERITOR LISA (All Models) - Guide Pin & Seal Kits

EBS Part No	Application	Image
ECKM.13	D LISA	<p>100 mm</p> <p>150 mm</p> <p>35x131 mm</p> <p>35 x 79 mm</p>
	SJ4076	
ECKM.54	C LISA	<p>30 x 115 mm</p> <p>30 x 75mm</p> <p>135 mm</p> <p>95 mm</p>
	SJ4052	

EBS MERITOR LISA (All Models) - Bushes, Caps, Screws & Seals

EBS Part No	Application	Image
ECKM.516	D LISA	
	BUSHES (Pack Qty 10)	
ECKM.7	C LISA D LISA	
	BOOTS & SEALS	

EBS MERITOR LISA (All Models) - Guide Pins & Bolts

EBS Part No	Application	Image
ECKM.517	C LISA D LISA (Pack Qty 7)	<p>M14x1.5 x 90 mm</p>

EBS MERITOR LISA (All Models) - Adjusting Mechanism & Spares

EBS Part No	Application	Image
ECKM.10	C LISA D LISA	
	ADJUSTING MECHANISM LEFT HAND	

CALIPERS & REPAIR KITS

EBS MERITOR LISA (All Models) - Adjusting Mechanism & Spares

ECKM.10.2		ECKM.11.1		ECKM.11.2		ECKM.11.3	
Application	C LISA/ D LISA ADJUSTING MECHANISM RIGHT HAND	Application	C LISA/ D LISA SHAFT LEFT HAND	Application	C LISA/ D LISA SHAFT BASE LEFT HAND	Application	C LISA/ D LISA BALLS
ECKM.11.4		ECKM.11.P		ECKM.11.V		ECKM.12.1	
Application	C LISA/ D LISA SPRING	Application	C LISA/ D LISA PIN	Application	C LISA/ D LISA OPERATING SHAFT LEFT HAND	Application	C LISA/ D LISA SHAFT RIGHT HAND
ECKM.12.2		ECKM.12.V		ECKM.15		ECKM.15.1	
Application	C LISA/ D LISA SHAFT BASE RIGHT HAND	Application	C LISA/ D LISA OPERATING SHAFT RIGHT HAND	Application	C LISA/ D LISA ADJUSTER TAPPET LEFT HAND	Application	C LISA/ D LISA ADJUSTER TAPPET RIGHT HAND

EBS MERITOR LISA (All Models) - Brake Pad Retainers & Fixings

EBS Part No	Application	Image
ECKM.11.5	D LISA	
	PAD PUSH PLATE	
ECKM.11.6	D LISA	

EBS MERITOR LISA (All Models) - Bearings, Cams & Spares

EBS Part No	Application	Image
ECKM.14	C LISA D LISA	
	NEEDLE & ROLLER BEARINGS	

EBS Repair Kits For **WABCO** **PAN17**

EBS WABCO PAN17 - Guide Pin & Seal Kits

EBS Part No	Application	Image
ECKW.2	PAN 17	
	40175058	
	40175059	
	40175060	
	40175061	
	40175070	
	40175071	
40175072		
40175073		

EBS WABCO PAN17 - Guide Pins & Bolts

EBS Part No	Application	Image
ECKW.17.2	PAN 17	
	40175051	
	40175052	
	40175070	
	40175071	

EBS WABCO PAN17 - Bushes, Caps, Screws & Seals

EBS Part No	Application	Image
ECKW.7	PAN 17	
	40175062	
	40175063	
	40175064	
40175065		
ECKW.8	PAN 17	
	40175025	
	40175026	
	40175027	
	40175028	
	40175049	
	40175050	
40175051		
40175052		
ECKW.17.1	PAN 17	
	40175051	
	40175052	
	40175070	
40175071		

EBS Part No	Application	Image
ECKW.10	PAN 17	
	40175074	
	40175075	
	40175076	
40175077		
ECKW.11	PAN 17	
	40175074	
	40175075	
	40175076	
	40175077	
ECKW.12.4	PAN 17	
	40175- - -	

CALIPERS & REPAIR KITS

EBS WABCO PAN17 - Operating Levers & Spares

ECKW.12		ECKW.12.1		ECKW.12.2		ECKW.12.3	
Application	PAN 17 40175- - -	Application	PAN 17 40175- - -	Application	PAN 17 40175- - -	Application	PAN 17 40175- - -

EBS WABCO PAN17 - Brake Pad Retainers & Fixings

EBS Part No	Application	Image
ECKW.17.3	PAN 17	
	40175051 40175070	
ECKW.17.5	PAN 17	
	40175052 40175071	

EBS WABCO PAN17 - Adjusting Mechanism & Spares

EBS Part No	Application	Image
EKS.3526.W1	PAN 17	
	40175- - -	

EBS WABCO PAN17 - Caliper Repair Tools

EBS Part No	Application	Image
ECKW.21	PAN 17	

EBS Repair Kits For **WABCO** PAN19

EBS WABCO PAN19 - Guide Pin & Seal Kits

EBS Part No	Application	Image
ECKW.4	PAN 19	<p>38x118 mm 38x76 mm</p>
	40195001 40195002 40195003 40195004	
ECKW.5	PAN 19	<p>120 mm 80 mm</p>
	40195007 40195008 40195009 40195010 40195011	
ECKW.6	PAN 19	<p>38 x 76 mm 38 x 118 mm</p>
	40195017 40195018 40195037 40195038 40195043	

EBS WABCO PAN19 - Bushes, Caps, Screws & Seals

EBS Part No	Application	Image
ECKW.5.1	PAN19	
	40195007 40195008 40195009 40195010 40195011	
ECKW.5.CAP	PAN 19	
ECKW.19.1	PAN 19	
	40195- - -	
ECKW.12.4	PAN 19	
	40195- - -	

CALIPERS & REPAIR KITS

**EBS WABCO PAN19
- Adjusting Mechanism & Spares**

EBS Part No	Application	Image
EKS.3526.W2	PAN 19	
	40195- - -	
ECKW.24.1	---	

**EBS WABCO PAN19
- Brake Pad Retainers & Fixings**

EBS Part No	Application	Image
ECKW.19.3	PAN 19	
	40195001 40195017	
ECKW.19.5	PAN 19	
	40195002 40195018	

**EBS WABCO PAN19
- Guide Pins & Bolts**

EBS Part No	Application	Image
ECKW.19.FL	PAN 19	

**EBS WABCO PAN19
- Guide Pins & Bolts**

EBS Part No	Application	Image
ECKW.12.CB	PAN 19/22	
	PAN 19	
ECKW.19.2	PAN 19	 <p>38 x 118 mm 38 x 76 mm</p> <p>90 mm 80 mm</p>
	40195- - -	

**EBS WABCO PAN19 -
Caliper Repair Tools**

EBS Part No	Application	Image
ECKW.22	PAN19	

EBS WABCO PAN19 - Operating Levers & Spares

EBS Part No	Application	Image
ECKW.12	PAN 19	
	40195- - -	

EBS Part No	Application	Image
ECKW.12.3	PAN 19	
	40195- - -	

EBS Repair Kits For **WABCO** **PAN22 & 22.5**

CALIPERS & REPAIR KITS

EBS WABCO PAN22 - Guide Pin & Seal Kits



Application	PAN 22-2
	40225003 40225004

EBS WABCO PAN22 - Bushes, Caps, Screws & Seals



Application	PAN 22-2
	40225003 40225004

EBS WABCO PAN22 - Operating Levers & Spares



Application	PAN 22
	40225003 40225004

EBS WABCO PAN22 - Caliper Repair Tools



Application	PAN22
-------------	-------

EBS WABCO PAN22 - Push Plates



Application	PAN 22
-------------	--------



Application	PAN 22
-------------	--------

EBS WABCO PAN22.5 DOUBLE PISTON SERIES

ECKW.24.3	
Application	PAN 22.5

ECKW.24.4	
Application	PAN 22.5

ECKW.24.7	
Application	LEVER GEAR & BEARING

ECKW.24.9	
Application	PAN 22.5 ROLLER BEARING

ECKW.24.10	
Application	PAN 22.5 BEARING SET

ECKW.24.11	
Application	PAN 22.5 BEARING SET

ECKW.24.12	
Application	PAN 22.5 FLANGE GASKET

EBS Repair Kits For **WABCO** MAXX 17, 22 & 22T

CALIPERS & REPAIR KITS

EBS REPAIR KITS FOR WABCO MAXX 17

ECKW.18.11	
	
Application	MAXX17
	ADJUSTMENT MECHANISM

EBS REPAIR KITS FOR WABCO MAXX 22 & 22T

ECKW.22.1	
 <p>80 mm 120 mm 38 x 118 mm 38 x 76 mm</p>	
Application	MAXX22
	GUIDE PIN & SEALS

ECKW.22.2	
	
Application	MAXX22
	ADJUSTING MECHANISM SET

ECKW.22.4	
	
Application	MAXX22
	SEALING SET

ECKW.22.5	
	
Application	MAXX22
	GAITER SET

EBS REPAIR KITS FOR WABCO MAXX 22 T

<p>ECKW.22.6</p>		<p>ECKW.22.7</p>		<p>ECKW.22.8</p>		<p>ECKW.22.9</p>	
Application	MAXX22 PRESSURE PLATE	Application	MAXX22 BEARING SET	Application	MAXX22 LEVER	Application	MAXX22 METAL COVER
<p>ECKW.22.10</p>		<p>ECKW.22.11</p>		<p>ECKW.22.16-PT</p>		<p>ECKW.23.1</p>	
Application	MAXX22 ADJUSTING MECH-ANISM SET	Application	MAXX22 COMPLETE ADJUSTING MECHANISM	Application	MAXX22 SENSOR	Application	MAXX22T GUIDE PIN & SEAL
<p>ECKW.23.7</p>		<p>ECKW.23.8</p>		<p>ECKW.23.9</p>		<p>ECKW.23.10</p>	
Application	MAXX22T METAL COVER	Application	MAXX22T LEVER	Application	MAXX22T METAL COVER	Application	MAXX22T ADJUSTMENT MECH SET
<p>ECKW.23.11</p>		<p>ECKW.23.L.C</p>		<p>ECKW.23.R.C</p>		<p>ECKW.26.8</p>	
Application	MAXX22T ADJUSTMENT MECH SET	Application	MAXX22T COMPLETE KIT LEFT	Application	MAXX22T COMPLETE KIT RIGHT	Application	MAXX22L LEVER

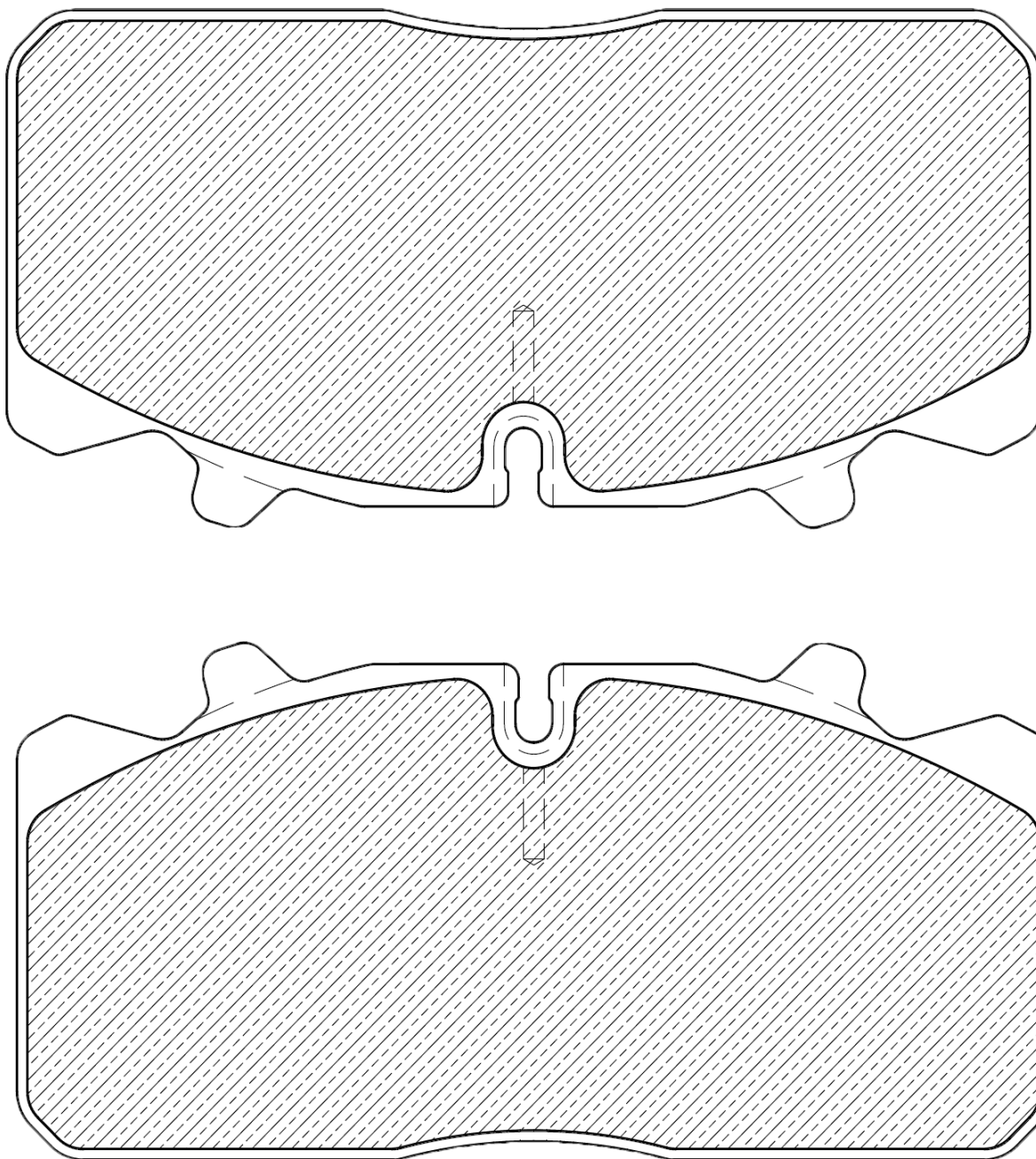

For Brake Pad Measuring Guide please see page 3A.2

EBS's range of brake pads are ECE R90 (Regulation 90) fully approved to the European Standard, controlling the manufacture, distribution, sale, installation and performance of all replacement brake pads and covers:

- **Brake performance pressure sensitivity**
(changes to brake performance over a range of braking application pressures).
- **Brake performance speed sensitivity**
(changes to brake performance with increased speed)
- **Brake fade behaviour**
(R13/R13H Type 1 test).
- **Brake performance in both unladen and laden weight conditions**
(R13/R13H Type 0 tests).

The EBS range of brake pads fully comply to these ECE R90 regulations and also carry the "E" (E11) approval number on each brake pad along with batch codes for traceability.

All brake pads in the EBS range are sold in axle sets of 4 pads, shrink wrapped, fully boxed and finished with a "tamper evident" seal and supplied complete with a fitting kit where detailed.

EBS also offer a full range of **Wear Lead Sensors** to compliment their Brake Pad range.





























BRAKE PAD MEASUREMENT GUIDE

(All measurements are in mm's)

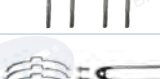

BRAKE PADS						
EBS Part No.	Pad Image	Fitting Kit (Included)	Wear Lead * (Sold Separately)	WVA	Pad Measurements (See p. 3A.2 for guide)	Application
EKBP.011			EKWL.108 EKWL.112	29011	A = 241 B = 125 C = 25	IVECO
EKBP.013			---	29013 29014	A = 180 B = 86 C = 20	RENAULT
EKBP.026		---	---	29017 29024 29026 29029	A = 191 B = 87 C = 23	DAEWOO DAF IVECO IVECO PSV LEYLAND
EKBP.030			EKWL.106 / EKWL.110 EKWL.111 / EKWL.113 EKWL.125 / EKWL.135 EKWL.137	29030 29083 29113	A = 250 B = 118 C = 28	ELSA 2
EKBP.032			EKWL.108 EKWL.112	29032	A = 206 B = 110 C = 25	IVECO
EKBP.043		---	EKWL.105 EKWL.106 EKWL.114	29043 / 29050 29051	A = 204 B = 96 C = 24	D2 FORD
EKBP.067		---	EKWL.101 / EKWL.102 EKWL.104 / EKWL.107 EKWL.109 / EKWL.119 EKWL.135	29033 / 29067 29039 / 29122 29055 / 29056 29302 / 29122 29374	A = 175 B = 86 C = 22	FORD CARGO IVECO EURO CARGO <i>PLEASE NOTE</i> EKBP.122 IS THE NEW UNIVERSAL TYPE TO REPLACE THIS
Replaced by EKBP.122			---	AMPA694 / AMPA697 / AMPAB016 / 80455700 / 12999665 / 29077 / 29092	A = 204.6 B = 106 C = 26.2	50 Series FA50.130 - FA50.180 55 Series FA55.150 - FA55.230
EKBP.087			EKWL.117 / EKWL.131 EKWL.133 / EKWL.134 EKWL.266 / EKWL.267	29059 / 29108 29061 / 29109 29087 / 29163 29108 / 29167 29042 / 29179 29105 / 29201	A = 247 B = 109 C = 30	SB7 UNIVERSAL FITMENT
EKBP.088			EKWL.120 EKWL.121 EKWL.122 EKWL.123	29088 29091 29117	A = 176 B = 83 C = 26	PAN 17 DAF IVECO
EKBP.090			EKWL.105 / EKWL.106 EKWL.113 / EKWL.114 EKWL.125 / EKWL.132	29090	A = 250 B = 114 C = 28	MERITOR RENAULT VOLVO
EKBP.095			EKWL.117 / EKWL.134 EKWL.135 / EKWL.266	29093 / 29094 29095 / 29096 29145 / 29184 29197	A = 210 B = 92 C = 30	SB6 BPW / DAF / SAF / IVECO / KNORR MAN / MERCEDES <i>Please note that this pad is not a universal fitment.</i>
EKBP.099		---	EKWL.132	29100	A = 214 B = 112 C = 25	C LISA
EKBP.115			---	29115 29116 29148 29183	A = 174 & 185** B = 84 C = 27 & 35**	SB 5 MERCEDES <i>PLEASE NOTE</i> **This set has 2 pads - Thick Backplate & 2 pads - Thin
EKBP.121		---	EKWL.119 EKWL.144	29121 29129 29357	A = 165 B = 66 C = 20	IVECO RENAULT

BRAKE PADS

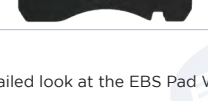
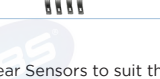

























EBS Part No.	Pad Image	Fitting Kit (Included)	Wear Lead * (Sold Separately)	WVA	Pad Measurements (See p. 3A.2 for guide)	Application
EKBP.122		---	EKWL.101 / EKWL.102 EKWL.104 / EKWL.107 EKWL.109 / EKWL.119 EKWL.135	29122 29374	A = 175 B = 86 C = 22	ALEXANDER AUWARTER BEULAS ESKER IVECO MAN MERCEDES OPTARE RENAULT SITCAR VOLVO
EKBP.123			EKWL.142 EKWL.149 EKWL.268	29123	A = 109 B = 63 C = 20	FORD IVECO
EKBP.124			EKWL.134	29124	A = 205 B = 102 C = 27	DX 195
EKBP.125			---	29125	A = 249 B = 111 C = 29	D DUCO VOLVO
EKBP.126			EKWL.126 EKWL.127 EKWL.150	29126 29159	A = 210 B = 85 C = 30	PAN 19 DAF
EKBP.131			EKWL.113 / EKWL.124 EKWL.125 / EKWL.135 EKWL.137 / EKWL.145	29131	A = 250 B = 118 C = 32	ELSA 2 MERITOR
EKBP.136			---	29136	A = 176 B = 89 C = 29	B DUCO
EKBP.137			---	29137	A = 210 B = 102 C = 29	C DUCO VOLVO
EKBP.142			EKWL.126 EKWL.127	29142	A = 205 B = 100 C = 30	PAN 19 O2
EKBP.143			EKWL.131	29143	A = 247 B = 105 C = 30	DB 20 HALDEX MERCEDES
EKBP.151			---	29151	A = 216 B = 97 C = 29	PAN 22 VOLVO
EKBP.158 <small>Replaces: EKBP.271</small>			EKWL.133 EKWL.266	29158 29171	A = 210 B = 108 C = 30	SK7 BPW/KNORR/SAF
EKBP.160			EKWL.101 EKWL.119 EKWL.144	29160 29161 29237	A = 165 B = 66 C = 19.8	IVECO MERCEDES NISSAN OPTARE RENAULT
EKBP.162			EKWL.151	29162	A = 210 B = 109 C = 31	PAN 22 SAF
EKBP.165			EKWL.117 EKWL.134 EKWL.135 EKWL.266 EKWL.267	29165 29215	A = 210 B = 92 C = 30	KNORR BREMSE SB6 UNIVERSAL "PAD KEY" TYPE
EKBP.167			EKWL.117 EKWL.133 EKWL.134 EKWL.266	29167	A = 247 B = 104 C = 30	KNORR BREMSE SB7 UNIVERSAL "PAD KEY" TYPE

* For a more detailed look at the EBS Pad Wear Sensors to suit the Pads listed here please go to section 3A.7 - 3A.10

BRAKE PADS						
EBS Part No.	Pad Image	Fitting Kit (Included)	Wear Lead * (Sold Separately)	WVA	Pad Measurements (See p. 3A.2 for guide)	Application
EKBP.169			---	29169 29177	A = 211 B = 100 C = 29	MERITOR DX195/ ELSA195 RENAULT VOLVO
EKBP.171 Replaced by EKBP.271			EKWL.133 EKWL.266	29171	A = 210 B = 108 C = 30	BPW SH Series KNORR BREMSE SK7000 "PAD KEY" TYPE
EKBP.173			EKWL.125	29173 29203	A = 216 B = 97 C = 29	ELSA 225 >98 VOLVO RVI
EKBP.174			EKWL.125 EKWL.141	29174 29204 29219 29226	A = 250 B = 107 C = 29	ELSA 225 VOLVO RVI
EKBP.181			---	29147 29181 29207	A = 211 B = 94 C = 30	HALDEX DB19
EKBP.187			---	29187	A = 250 B = 114 C = 29	OPTARE
EKBP.192			EKWL.140 EKWL.143 EKWL.152	29192	A = 164 B = 66 C = 19	MERCEDES PLAXTON VOLKSWAGEN
EKBP.195			---	29175 29195 29181 29274 29294	A = 210 B = 93.8 C = 30	HALDEX MODULT SBS2220
EKBP.195.A			---	---	A = 210 B = 91.4 C = 30	SAF
EKBP.200			EKWL.140 EKWL.143	29200	A = 169 B = 73 C = 20	MERCEDES PLAXTON SITCAR VOLKSWAGEN
EKBP.211			---	29211 29291	A = 216 B = 110.6 C = 30	MERITOR ELSA 225L-2
EKBP.227**			EKWL.153	29227 29316	A = 211 B = 102 C = 30	BPW SKH / SKM
EKBP.227.A			EKWL.153	29227 29316	A = 210.4 B = 102.9 C = 30	BPW SKH / SKM
EKBP.228**			EKWL.153	29228	A = 211 B = 115 C = 30	BPW SH SERIES BPW SM SERIES
EKBP.228.A			---	29228 29317 29355	A = 210.4 B = 118 C = 29.6	BPW TSB4309

** Please note - Patent / design rights owned by third parties on this item in some countries means that EBS does not offer for sale this item in those countries whilst such patent / design rights subsist.
 * For a more detailed look at the EBS Pad Wear Sensors to suit the Pads listed here please go to section 3A.7 - 3A.10

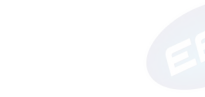
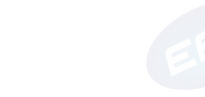
BRAKE PADS

EBS Part No.	Pad Image	Fitting Kit (Included)	Wear Lead * (Sold Separately)	WVA	Pad Measurements (See p. 3A.2 for guide)	Application
EKBP.229			EKWL.119 EKWL.146	29229 29230	A = 163 B = 67 C = 21	IVECO
EKBP.231			EKWL.119 EKWL.146	29231	A = 184 B = 65 C = 23	IVECO SITCAR
EKBP.232			EKWL.142	29232	A = 141 B = 73 C = 21	IVECO
EKBP.245**			---	29244 29245	A = 208 B = 114 C = 30/35	MERCEDES ACTROS 2010 REAR
EKBP.246**			---	29246 29247	A = 245 B = 113 C = 29.4/30.4	MERCEDES ACTROS 2010 FRONT
EKBP.253			---	29253	A = 247 B = 107 C = 30	DAF IVECO MAN MERCEDES SCANIA
EKBP.256		---	EKWL.265	29256	A = 176 B = 95 C = 27	BEULAS IVECO
EKBP.267			---	29127 29267	A = 247 B = 114 C = 30	BPW
EKBP.271			EKWL.133 EKWL.134	29271 29308	A = 210 B = 107.8 C = 30	KNORR SK7000 SAF
EKBP.279			---	29223 29279 29337	A = 217.5 B = 107.6 C = 30.8	MAN WABCO NG22MAX
EKBP.284			---	29284	A = 210.4 B = 90.6 C = 30.0	VOLVO RENAULT WABCO MAXX 19
EKBP.328			---	29328	A = 214.5 B = 107 C = 31	---
EKBP.331			---	29331	A = 247.5 B = 107.6 C = 30	---
EKBP.332			---	29332	A = 249.5 B = 110.8 C = 29.05	SCANIA
EKBP.340			---	29340	A=210 B=93.55 C=29.05	MERCEDES

BRAKE PADS						
EBS Part No.	Pad Image	Fitting Kit (Included)	Wear Lead * (Sold Separately)	WVA	Pad Measurements (See p. 3A.2 for guide)	Application
EKBP.345			---	29345	A = 220.7 B = 99.7 C = 30	MERCEDES
EKBP.484			EKWL.148	24484 22262	A = 166 B = 67.6 C = 18	FORD
EKBP.485			EKWL.148	24485 22263	A = 165 B = 65 C = 18	FORD
EKBP.486			EKWL.149 EKWL.268	24486 22017 25918	A = 123 B = 54 C = 17	FORD
EKBP.576		Clips attached	EKWL.115	21576 23990	A = 157 B = 65 C = 21	MERCEDES
EKBP.747		---	---	29747	A = 140 B = 121 C = 32	KNORR K85 MAN NEOPLAN VAN HOOL
EKBP.835		---	EKWL.107 EKWL.115 EKWL.140	20835 29835 29839	A = 175 B = 83 C = 22	ESKER MERCEDES OPTARE PLAXTON SITCAR
95396			---	29175 29195 29274	A = 210 B = 94 C = 30	SAF SBS2220 HALDEX MODULT



BRAKE PADS, WEAR LEADS & REPAIR KITS

BRAKE PAD FITTING KITS

EBS Part No.	Kit Image	Fits With
EKBK.088		EKBP.088
EKBK.090		EKBP.090
EKBK.095		EKBP.095
EKBK.115		EKBP.115
EKBK.124		EKBP.124
EKBK.131		EKBP.030 EKBP.090 EKBP.131
EKBK.251		EKBP.173 EKBP.174
EKBK.279		EKBP.279
EKBK.510		EKBP.126
EKBK.516		EKBP.122 EARLY IVECO
EKBK.524		EKBP.122 LATE IVECO
EKBK.529		EKBP. 122 EKBP. 256 EKBP. 835
EKBK.531		EKBP.256

BRAKE PAD WEAR LEADS

EBS Part No.	Wear Lead Image	Brake Pad Fits With	Length Position	Application
EKWL.001		---	0.80M Rear	VOLVO
EKWL.002		---	1.50M Front	VOLVO
EKWL.003		---	2.60M Right Hand	VOLVO White plug
EKWL.004		---	2.60M Left Hand	VOLVO Red plug
EKWL.005		---	1.56M Right Hand	VOLVO White plug
EKWL.006		---	1.56M Left Hand	VOLVO Red plug
EKWL.007		---	1.85M Right Hand	VOLVO White plug
EKWL.008		---	1.85M Left Hand	VOLVO Red plug
EKWL.010		---	2.80M	RENAULT Orange plug
EKWL.011		---	2.30M	RENAULT Orange
EKWL.012		---	1.40M	RENAULT Black plug
EKWL.013		---	1.40M	RENAULT Orange plug
EKWL.014		---	1.28M Green plug	RENAULT
EKWL.015		---	1.28M Green plug	RENAULT
EKWL.016		---	3.60M Green plug	RENAULT

PLEASE NOTE - Most of the Brake Pads supplied by EBS have the fitting kits included where applicable.

BRAKE PAD WEAR LEADS				
EBS Part No.	Wear Lead Image	Brake Pad Fits With	Length Position	Application
EKWL.017		---	5.20M	RENAULT
				Green plug
EKWL.018		---	2.50M	MAN
				Black plug
EKWL.019		---	1.35M	MAN
				Black plug
EKWL.020		---	2.15M	MAN
				Black plug
EKWL.021		---	1.75M	MAN
				Black plug
EKWL.022		---	1.75M	MAN
				Orange plug
EKWL.023		---	2.15M	MAN
				Orange plug
EKWL.024		---	2.50M	MAN
				Orange plug
EKWL.025		---	1.75M	RENAULT
				Green plug
EKWL.026		---	2.30M	VOLVO
				Red plug
EKWL.027		---	1.07M	VOLVO
				Red plug
EKWL.028		---	2.00M	VOLVO
				Red plug
EKWL.029		---	1.75M	RENAULT
				Grey plug
EKWL.031		---	1.62M	VOLVO
				Green plug
EKWL.032		---	3.30M	VOLVO
				Green plug

BRAKE PAD WEAR LEADS				
EBS Part No.	Wear Lead Image	Brake Pad Fits With	Length Position	Application
EKWL.033		---	5.20M	VOLVO
				Green plug
EKWL.034		---	3.60M	VOLVO
				Green plug
EKWL.035		---	1.62M	VOLVO
				Green plug
EKWL.037		---	1.80M	VOLVO
				Orange plug
EKWL.038		---	1.80M	VOLVO
				Orange plug
EKWL.039		---	1.85 M	VOLVO
				Red plug
EKWL.040		---	1.85 M	VOLVO
				Front & Rear Red plug
EKWL.041		---	1.35 M	VOLVO

EKWL.043		---	---	MERITOR

EKWL.044		---	2.40M	MERITOR

EKWL.045		---	1.6M	MERITOR

EKWL.046		---	---	VOLVO MERITOR

EKWL.047		---	1.4 M	VOLVO MERITOR

EKWL.048		---	2650 mm	VOLVO MERITOR

EKWL.101		EKBP.122	500mm	BEULAS IVECO
				Front & Rear

BRAKE PADS, WEAR LEADS & REPAIR KITS

BRAKE PAD WEAR LEADS				
EBS Part No.	Wear Lead Image	Brake Pad Fits With	Length Position	Application
EKWL.102		EKBP.122	490mm	FORD IVECO RENAULT VOLVO
			Front & Rear	
EKWL.104		EKBP.122	245mm	VOLVO
			Front & Rear	
EKWL.107		EKBP.122 EKBP.835	530mm	ALEXANDER AUWARTER ESKER MERCEDES OPTARE PLAXTON
			Front & Rear	
EKWL.108		EKBP.011 EKBP.032	380mm	IVECO
			Front & Rear	
EKWL.109		EKBP.122	920mm	RENAULT
			Front	
EKWL.110		EKBP.030	360mm	DENNIS IKARUS KASSBOHRER MAN NOGE VAN HOOL
			Front & Rear	
EKWL.111		EKBP.030	380mm	HEULIEZ KAROSA RENAULT
			Front	
EKWL.112		EKBP.011 EKBP.032	430mm	IVECO
			Front	
EKWL.113		---	---	RENAULT
EKWL.115		EKBP.835	215mm	MERCEDES OPTARE PLAXTON
			Front & Rear	
EKWL.117		EKBP.087 EKBP.095	290mm	AUWARTER BOVA CAETANO DAF DENNIS FONTENAX IVECO KASSBOHRER PLAXTON
			Front, Middle & Rear	
EKWL.119		EKBP.122	300mm	ESKER IVECO SITCAR
			Front & Rear	
EKWL.120		EKBP.088	330mm	DAF IVECO OPTARE
			Front & Rear	

BRAKE PAD WEAR LEADS				
EBS Part No.	Wear Lead Image	Brake Pad Fits With	Length Position	Application
EKWL.121		EKBP.088	360mm	IVECO
			Front & Rear	
EKWL.122		EKBP.088	315mm	BMC MAN
			Front & Rear	
EKWL.123		EKBP.088	340mm	RENAULT
			Front & Rear	
EKWL.124		EKBP.131	370mm	ERF MAN
			Front, Middle & Rear	
EKWL.125		EKBP.030 EKBP.090 EKBP.131 EKBP.173 EKBP.174	350mm	DENNIS MERITOR RENAULT VAN HOOL VOLVO
			Front & Rear	
EKWL.126		EKBP.126 EKBP.142	380mm	DAF DENNIS VOLVO
			Front & Rear	
EKWL.127		EKBP.126 EKBP.142	460mm	RENAULT
			Front & Rear	
EKWL.128		Fits with: EKWL.117 EKWL.131	1300mm	For use with: EKWL.117 OR EKWL.131 in order to make a complete lead
			N/A	
EKWL.131		EKBP.087 EKBP.143	270mm	ESKER FONTENAX IVECO OPTARE PLAXTON SCANIA
			Front, Middle & Rear	
EKWL.132		EKBP.090 EKBP.099	230mm	AUWARTER DENNIS FONTENAX IVECO MERITOR NISSAN RENAULT VOLVO
			Front & Rear	
EKWL.133		EKBP.087 EKBP.158	360mm	KNORR BREMSE
			Trailer	
EKWL.134		EKBP.087 EKBP.095 EKBP.124	760mm	MERITOR SMB
			Trailer	
EKWL.137		EKBP.030 EKBP.131	390mm	MAN
			Front, Middle & Rear	
EKWL.140		---	---	MERCEDES

BRAKE PAD WEAR LEADS				
EBS Part No.	Wear Lead Image	Brake Pad Fits With	Length Position	Application
EKWL.141		EKBP.174	395mm Front & Rear	MERITOR OPTARE RENAULT
EKWL.142		WVA 24570 29232	300mm Rear	IVECO
EKWL.143		WVA 29192,29190 29200,29217	100mm Front & Rear	MERCEDES OPTARE PLAXTON VW
EKWL.144		WVA 29121,29129 29357,29160 29161,29237	260mm Front & Rear	RENAULT
EKWL.145		EKBP.131	355mm Front	MAN
EKWL.146		WVA 29229,29231	125mm Front & Rear	ESKER IVECO
EKWL.150		EKBP.126	760mm Trailer	SAF WABCO
EKWL.151		EKBP.162	760mm Trailer	SAF WABCO
EKWL.152		WVA 24007,24008	115mm Front & Rear	MERCEDES
EKWL.154		EKBP.087 EKBP.095	--- Front & Rear	IVECO
EKWL.156		---	--- ---	MERCEDES
EKWL.157		---	294 mm ---	BPW
EKWL.158		---	--- ---	IVECO
EKWL.159		---	--- ---	RENAULT
EKWL.160		EKBP.160	--- ---	MAN

BRAKE PAD WEAR LEADS				
EBS Part No.	Wear Lead Image	Brake Pad Fits With	Length Position	Application
EKWL.265		EKBP.256	210mm Front & Rear	BEULAS IVECO

BRAKE PADS, WEAR LEADS & REPAIR KITS

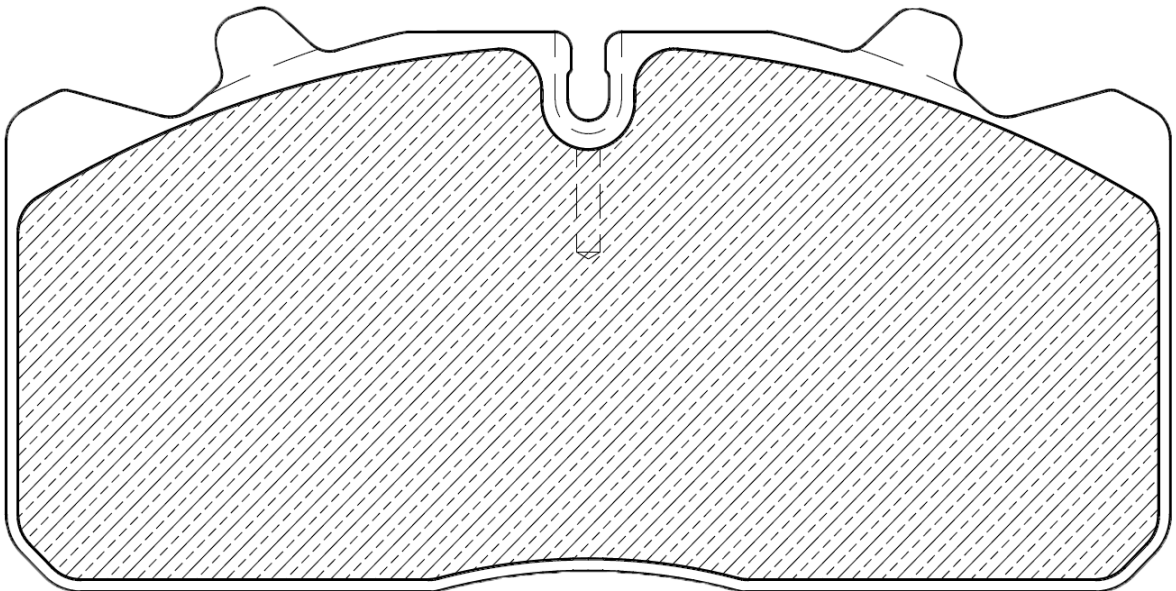
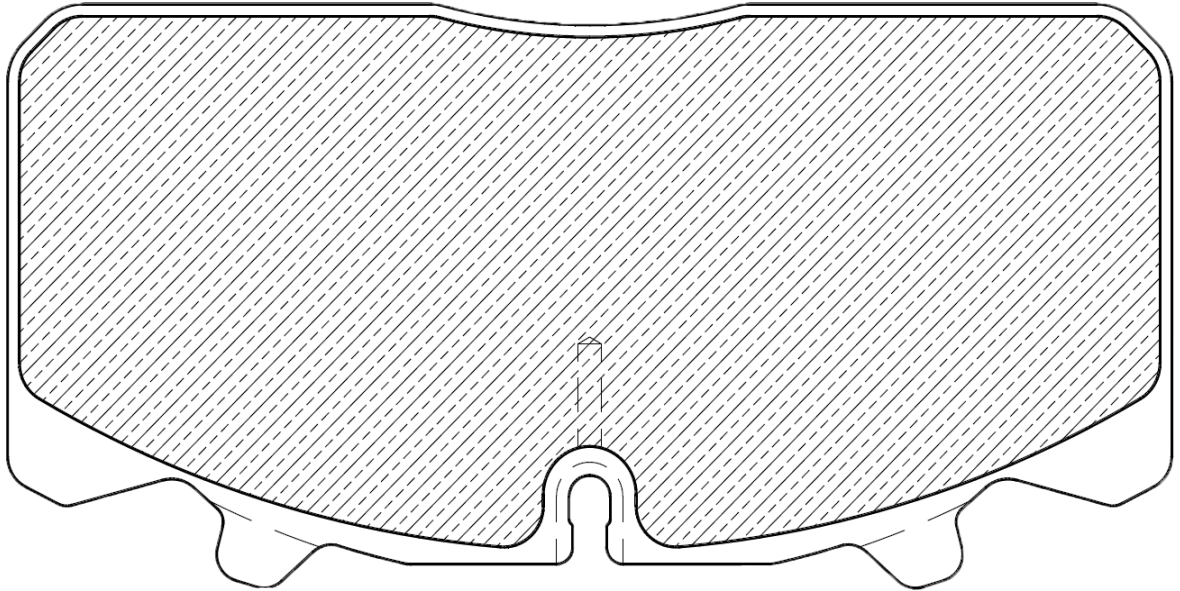

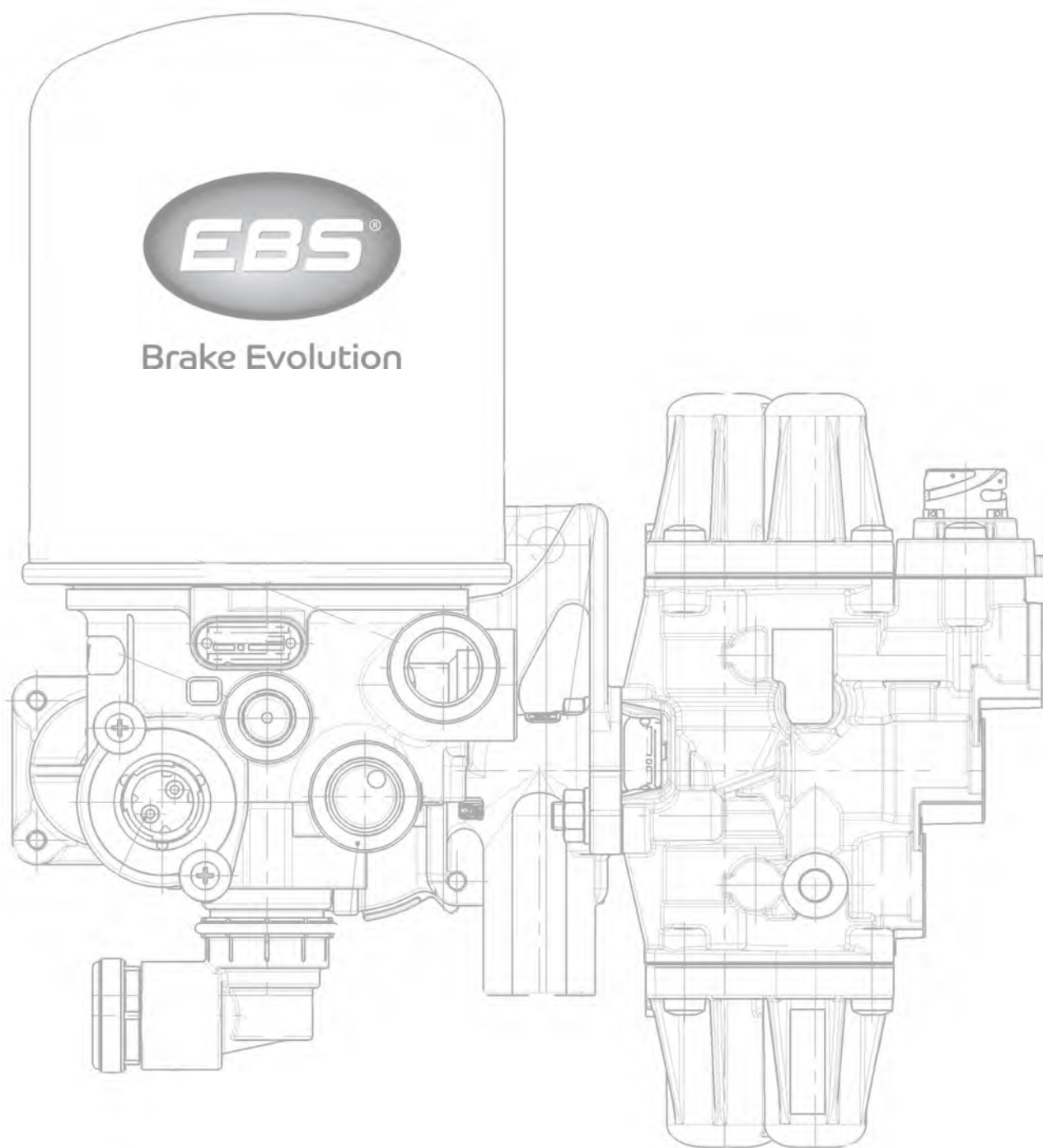



EBS KNORR AIR PROCESSING UNITS

EBS Part No	Image	Alternative Part No	Alternative Part No	Filter	Heater	Repair Kit For Air Dryer	Repair Kit For MCPV
04.02.1400	1	ZB4400	K002241	EBS2227F	---	EKKB.63.20	---
04.02.1402	1	ZB4402	K004997	EBS2227F	EKKB.63.78	EKKB.63.20	---
04.02.1414	1	ZB4414	K007498	EBS2227F	---	EKKB.63.20	---
04.02.1424	1	ZB4424	K010593	EBS2227F	EKKB.63.7	EKKB.63.20	---
04.02.1427	1	ZB4427	K028207	EBS2232F	EKKB.63.78	EKKB.63.20	---
04.02.1505	2	ZB4505	I117788	EBS2227F	---	EKKB.63.2	EKKB.80
04.02.1506	2	ZB4506	I132582N00	EBS2227F	---	EKKB.63.2	EKKB.80
04.02.1511	2	ZB4511	I135530170	EBS2227F	EKKB.63.24	EKKB.63.2	EKKB.80
04.02.1512	2	ZB4512	I135531	EBS2227F	EKKB.63.24	EKKB.63.2	EKKB.80
04.02.1513	2	ZB4513	I136006	EBS2227F	EKKB.63.24	EKKB.63.2	EKKB.80
04.02.1528	2	ZB4528	K010515	EBS2227F	EKKB.63.24	EKKB.63.2	EKKB.80
04.02.1534	2	ZB4534	I138310FN00	EBS2227F	EKKB.63.24	EKKB.63.2	EKKB.80
04.02.1535	2	ZB4535	I138310FN00	EBS2227F	EKKB.63.24	EKKB.63.2	EKKB.80
04.02.1544	2	ZB4544	I138619FN00 K114274	EBS2227F	EKKB.63.78	EKKB.63.2	EKKB.80
04.02.1564	2	ZB4564	I139866F K114269	EBS2227F	EKKB.63.24	EKKB.63.2	EKKB.80
04.02.1578	2	ZB4578	K000394N00 K114269	EBS4525F	EKKB.63.78	EKKB.63.3	EKKB.80
04.02.1579	2	ZB4579	K000395N00	EBS4525F	EKKB.63.78	EKKB.63.3	EKKB.80
04.02.1580	2	ZB4580	K000396N00 K114270	EBS4525F	EKKB.63.78	EKKB.63.3	EKKB.80
04.02.1583	2	ZB4583	K001002N00	EBS4525F	EKKB.63.78	EKKB.63.3	EKKB.80
04.02.1586	2	ZB4586	K012242N00	EBS4525F	EKKB.63.78	EKKB.63.3	EKKB.80
04.02.1587	2	ZB4587	K012243N00	EBS2227F	EKKB.63.78	EKKB.63.3	EKKB.80
04.02.1592	2	ZB4592	K012245N00	EBS2227F	EKKB.63.78	EKKB.63.3	EKKB.80
04.02.1593	2	ZB4593	K012246N00	EBS2227F	EKKB.63.78	EKKB.63.3	EKKB.80
04.02.1596	2	ZB4596	K001458N00	EBS2227F	EKKB.63.78	EKKB.63.3	EKKB.80
04.02.1597	2	ZB4597	K001459N00	EBS2227F	EKKB.63.78	EKKB.63.3	EKKB.80
04.02.1600	2	ZB4600	K001982N00	EBS2227F	EKKB.63.78	EKKB.63.3	EKKB.3.4
04.02.1601	2	ZB4601	K001983N00	EBS2227F	---	EKKB.63.3	EKKB.3.4
04.02.1602	2	ZB4602	K001984N00	EBS2232F	EKKB.63.78	EKKB.63.3	EKKB.3.4
04.02.1603	2	ZB4603	K001985N00	EBS2227F	---	EKKB.63.3	EKKB.3.4
04.02.1631	2	ZB4631	K043833N00	EBS2232F	---	EKKB.63.4	EKKB.80
04.02.1633	2	ZB4633	K043835	EBS2227F	---	---	EKKB.3.4
04.02.1636	2	ZB4636	K043838N00	EBS2227F	---	---	EKKB.3.4
04.02.1700	2	ZB4700	K011986N00	EBS4525F	EKKB.63.78	EKKB.63.3	EKKB.80
04.02.1701	2	ZB4701	K011987N00	EBS4525F	EKKB.63.78	EKKB.63.3	EKKB.80
04.02.1706	2	ZB4706	K014682N00 K114272	EBS9455F	EKKB.63.78	EKKB.63.3	EKKB.80
04.02.1707	2	ZB4707	K014683N00	EBS9455F	EKKB.63.78	EKKB.63.3	EKKB.80

All Filters are detailed on page 1.10 to 1.11 - For Heaters see page 4.6 - For Silencers please see pages 90.8, 90.9

PLEASE NOTE - Unit may require programming



EBS KNORR AIR PROCESSING UNITS

EBS Part No	Image	Alternative Part No	Alternative Part No	Filter	Heater	Repair Kit For Air Dryer	Repair Kit For MCPV
04.02.1708	2	ZB4708	K014684N00	EBS9455F	EKKB.63.78	EKKB.63.3	EKKB.80
04.02.1730	2	ZB4730	K042283N00	EBS2227F	---	---	---
04.02.1731	2	ZB4731	K043824N00	EBS2227F	---	---	---
04.02.1732	2	ZB4732	K043828N00	EBS2227F	---	---	---
04.02.1733	2	ZB4733	K043829N00	EBS2227F	---	---	---
04.02.1734	2	ZB4734	K043830N00	EBS2227F	EKKB.63.78	EKKB.63.4	EKKB.82
04.02.1735	2	ZB4735	K043831N00	EBS2227F	---	---	---
04.02.1736	2	ZB4736	K043845N00	EBS2227F	---	---	EKKB.80
04.02.1737	2	ZB4737	K043846N00	EBS2227F	---	---	EKKB.80
04.02.1738	2	ZB4738	K043847N00	EBS2227F	---	---	EKKB.80
04.02.1739	2	ZB4739	K043848N00	EBS2227F	---	---	EKKB.80
04.02.1740	2	ZB4740	K043849N00	EBS2227F	---	---	EKKB.80
04.02.1741	2	ZB4741	K043850N00	EBS2227F	---	---	EKKB.80
04.02.1742	2	ZB4742	K043851N00	EBS2227F	---	---	---

All Filters are detailed on page 1.10 to 1.11 - For Heaters see page 4.6 - For Silencers please see pages 90.8, 90.9

PLEASE NOTE: Unit may require programming

EBS KNORR AIR PROCESSING UNITS

EBS Part No	Image	Alternative Part No	Alternative Part No	Filter	Heater	Repair Kit For Air Dryer	Repair Kit For MCPV
04.02.1803	3	ZB4803	K002736N00	EBS2227F	EKKB.63.24	EKKB.63.2	EKKB.81
04.02.1809	3	ZB4809	K025295N00	EBS2232F	EKKB.63.24	EKKB.63.2	EKKB.81

EBS KNORR EAC AIR PROCESSING UNITS

EBS Part No	Image	Alternative Part No	Alternative Part No	Filter	Repair Kit	Repair Kit
R04.02.5906	4	K105906N50 K105907N50	K079182N50	EBS2262F	EKKB.63.21	---

PLEASE NOTE: Unit may require programming

EBS KNORR EAC AIR PROCESSING UNITS - VOLVO / RVI / MERCEDES

EBS Part No	Image	Alternative Part No	Alternative Part No	Filter	Repair Kit	Repair Kit
R04.02.0741	4	K020741N50 K020741X50	EL1100	EBS2262F	EKKB.63.21	---
R04.02.0742	4	K020742N50	EL1101	EBS2262F	EKKB.63.21	---
R04.02.8209	5	K078209N50	EL2201	K102196	EKKB.63.22	---
---	5	K138263N50	EL2201	K102196	EKKB.63.22	---
---	5	K148329N50	EL2201	K102196	EKKB.63.22	---

PLEASE NOTE: Unit may require programming

AIR PROCESSING UNITS



EBS WABCO AIR PROCESSING UNITS - 932500 SERIES

EBS Part No	Image	Alternative Part No	Filter	Heater	Repair Kit	Repair Kit	Repair Kit
04.01.1003	6	9325000030	EBS2232F	---	EKWA.63.40	EKWA.80	EKWA.80.1
04.01.1006	6	9325000060	EBS2232F	---	EKWA.63.40	EKWA.80	EKWA.80.1
04.01.1007	6	9325000070	EBS2232F	EKWA.63.30	EKWA.63.40	EKWA.80	EKWA.80.1
04.01.1013	6	9325000130	EBS2232F	---	EKWA.63.40	EKWA.80	EKWA.80.1
04.01.1014	6	9325000140	EBS2232F	EKWA.63.30	EKWA.63.40	EKWA.80	EKWA.80.1
04.01.1015	6	9325000150	EBS2232F	EKWA.63.30	EKWA.63.40	EKWA.80	EKWA.80.1
04.01.1021	6	9325000210	EBS2232F	EKWA.63.30	EKWA.63.40	EKWA.80	EKWA.80.1
04.01.1035	6	9325000350	EBS2232F	EKWA.63.7	EKWA.63.40	EKWA.80	EKWA.80.1
04.01.1040	6	9325000400	EBS2232F	---	EKWA.63.40	EKWA.80	EKWA.80.1
04.01.1101	7	9325001010	EBS2227F	EKWA.63.30	EKWA.63.20	EKWA.80	EKWA.80.1
					EKWA.63.5	EKWA.63.24	EKWA.63.52
04.01.1102	7	9325001020	EBS2227F	EKWA.63.30	EKWA.63.20	EKWA.80	EKWA.80.1
					EKWA.63.5	EKWA.63.24	EKWA.63.52
04.01.1103	7	9325001030	EBS2227F	EKWA.63.30	EKWA.63.20	EKWA.80	EKWA.80.1
					EKWA.63.5	EKWA.63.24	EKWA.63.52
04.01.1110	7	9325001100	EBS2232F	EKWA.63.30	EKWA.63.20	EKWA.80	EKWA.80.1
					EKWA.63.5	EKWA.63.24	EKWA.63.52

EBS WABCO Air Processing Units - 932510 Series - For SCANIA

EBS Part No	Image	Alternative Part No	Filter	Heater	Repair Kit	Repair Kit	Repair Kit	Repair Kit
04.01.2009	8	9325100090 9325100100	EBS2282F	---	EKWA.64.40	EKWA.64.41	EKWA.64.42 EKWA.64.43	EKWA.81 EKWA.64.52
01.01.8050	8	9325100500	EBS2282F	---	EKWA.64.40	EKWA.64.41	EKWA.64.42	EKWA.81
01.01.8956	9	9325109562	EBS2282F	---	EKWA.64.40	EKWA.64.41	EKWA.64.42	---
18.01.4958	10	9325109582	---	---	EKWA.81	EKWA.80.2	---	---
---	11	1941956	---	---	---	---	---	---

PLEASE NOTE: Unit may require programming

EBS KNORR BREMSE REPAIR KITS

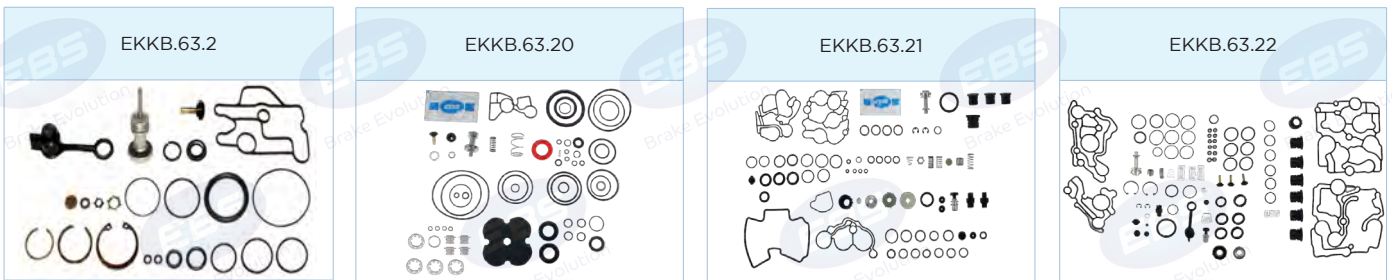

EBS KNORR BREMSE REPAIR KITS

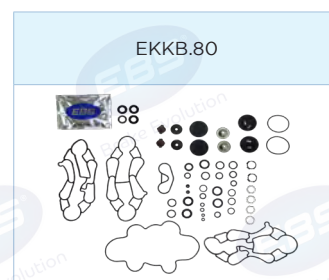
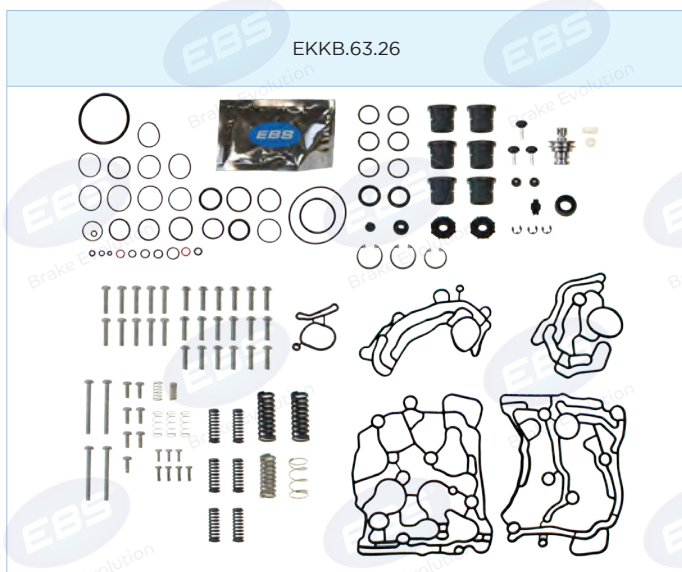

EBS KNORR BREMSE APU RELAY VALVE



EBS WABCO REPAIR KITS



AIR PROCESSING UNITS

EBS WABCO REPAIR KITS

EKWA.64.43

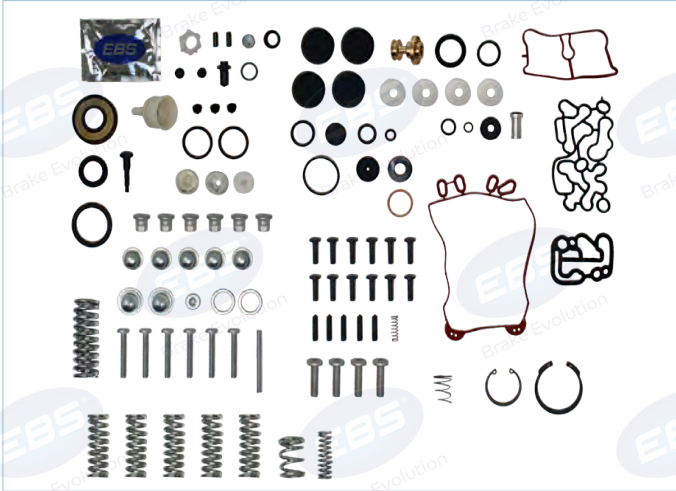

EKWA.64.52



EKWA.80

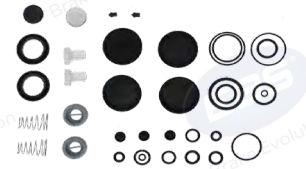

EKWA.80.1



5 VOLT

EKWA.80.1A



24 VOLT

EKWA.80.2



EKWA.81



EKWA.65.1



EKWA.65.A



EKWA.65.B



EBS KNORR BREMSE AIR DRYER HEATER ELEMENTS



EBS WABCO AIR DRYER HEATER ELEMENTS



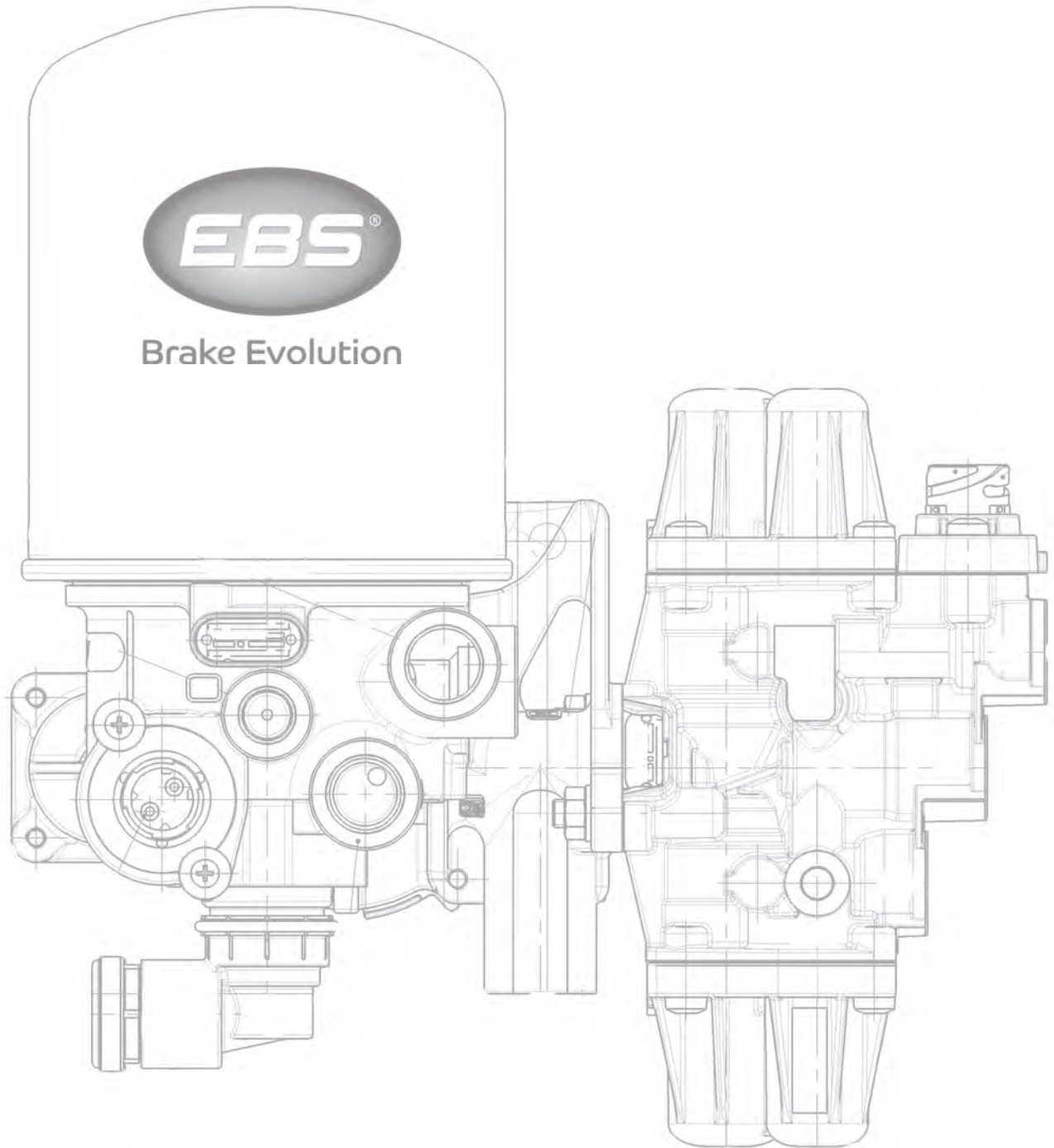

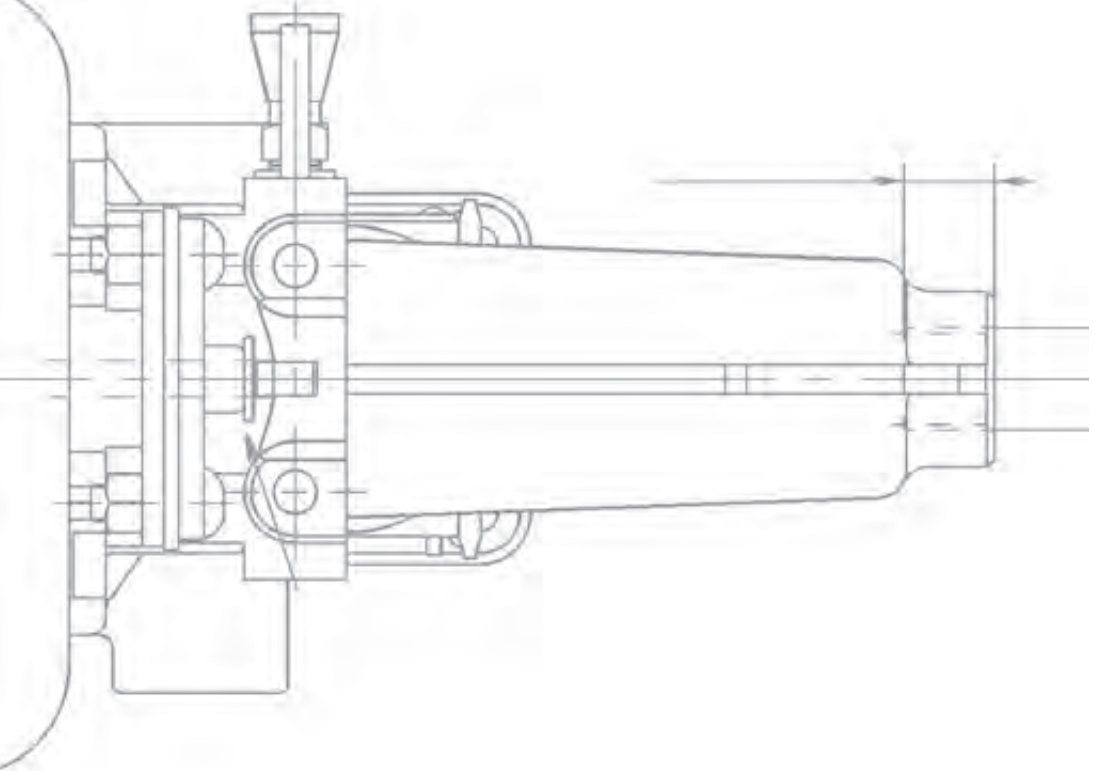
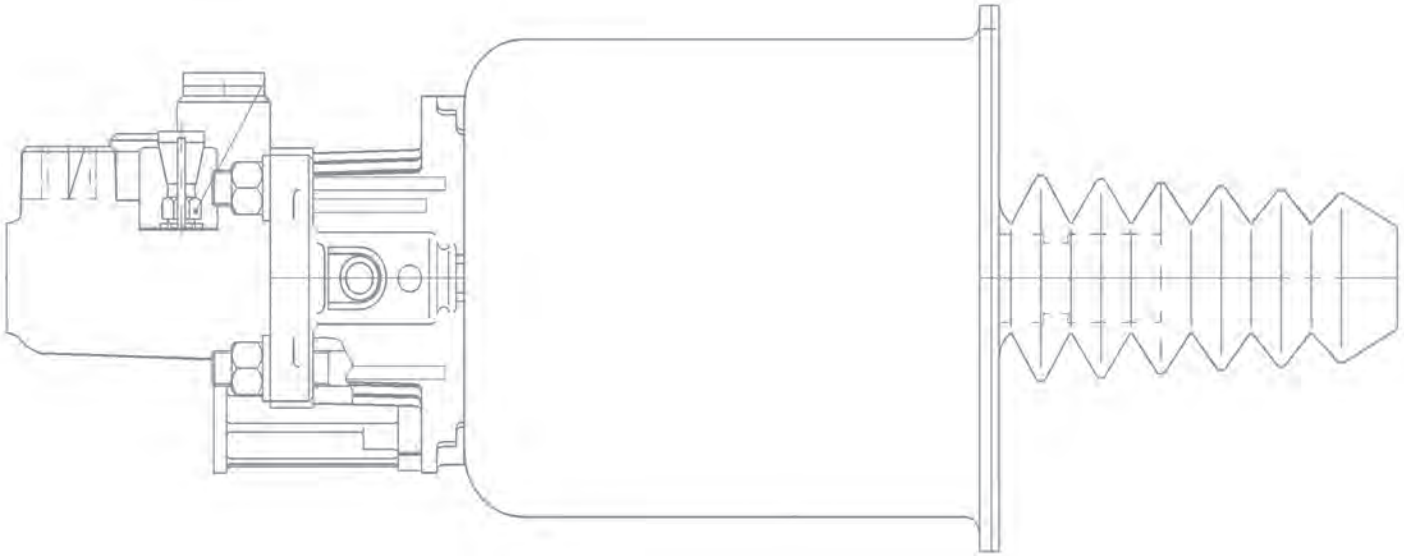

CLUTCH SERVO & CONTROL

CLUTCH SERVOS - KNORR BREMSE

05.02.1156		05.02.1200		05.02.1204		05.02.1208	
Knorr Bremse Part No	VG3156	Knorr Bremse Part No	VG3200	Knorr Bremse Part No	VG3204	Knorr Bremse Part No	VG3208
Repair Kit	EKKB.28	Repair Kit	EKKB.28.1	Repair Kit	EKKB.28.1	Repair Kit	EKKB.28.2
05.02.1213		05.02.1215		05.02.1218		05.02.1224	
Knorr Bremse Part No	VG3213	Knorr Bremse Part No	VG3215	Knorr Bremse Part No	VG3218	Knorr Bremse Part No	VG3224
Repair Kit	EKKB.28.2	Repair Kit	EKKB.28.2	Repair Kit	EKKB.28.2	Repair Kit	EKKB.28.2
05.02.1227		05.02.1228		05.02.1229		05.02.1234	
Knorr Bremse Part No	VG3227	Knorr Bremse Part No	VG3228	Knorr Bremse Part No	VG3229	Knorr Bremse Part No	VG3234
Repair Kit	EKKB.28.2	Repair Kit	EKKB.28.2	Repair Kit	EKKB.28.2	Repair Kit	EKKB.28.1
05.02.1261		05.02.1262		05.02.1267		05.02.1268	
Knorr Bremse Part No	VG3261	Knorr Bremse Part No	VG3262	Knorr Bremse Part No	VG3267	Knorr Bremse Part No	VG3268
Repair Kit	EKKB.28.2	Repair Kit	EKKB.28.1	Repair Kit	EKKB.28.1	Repair Kit	EKKB.28.6.1
---		05.02.1276		05.02.1284		05.02.1286	
Knorr Bremse Part No	VG3269	Knorr Bremse Part No	VG3276	Knorr Bremse Part No	VG3284	Knorr Bremse Part No	VG3286
Repair Kit	EKKB.28.6	Repair Kit	EKKB.28.2	Repair Kit	EKKB.28.2	Repair Kit	EKKB.28.6.1

CLUTCH SERVOS - KNORR BREMSE

05.02.1288		05.02.1289		05.02.1304		05.02.1361	
							
Knorr Bremse Part No	VG3288 VG3264	Knorr Bremse Part No	VG3289	Knorr Bremse Part No	VG3304	Knorr Bremse Part No	VG3361
Repair Kit	EKKB.28.6	Repair Kit	EKKB.28.6	Repair Kit	EKKB.28.1	Repair Kit	EKKB.28.3C
---		05.02.1874		05.02.4873		05.02.4874	
							
Knorr Bremse Part No	VG3364	Knorr Bremse Part No	K021874N00	Knorr Bremse Part No	K044873N00	Knorr Bremse Part No	K044874N00
Repair Kit	EKKB.28.3C	Repair Kit	---	Repair Kit	---	Repair Kit	---
05.02.2028		05.02.9547					
							
Knorr Bremse Part No	K044873N00	Knorr Bremse Part No	K049547N00				
Repair Kit	---	Repair Kit	---				

CLUTCH SERVOS - KONGSBERG - BOVA

EBS Part No	Diameter	Kongsberg Part No	Repair Kit - Main	Repair Kit - Air Valve	Repair Kit	Image
05.62.8036	100mm	628036	EKKO.25.21	EKKO.25.33	---	 <p>Brake Fluid</p>

CLUTCH SERVO & CONTROL

CLUTCH SERVOS - KONGSBERG - DAF

EBS Part No	Diameter	Kongsberg Part No	Repair Kit - Main	Repair Kit - Air Valve	Repair Kit - Spool Assy	Repair Kit	Image
05.05.1003	80mm	1000509122AM	---	---	---	---	 Brake Fluid
05.05.1004	80mm	1000510486AM	---	---	---	---	 Brake Fluid
05.05.1007	80mm	1000332427AM	---	---	---	---	 Brake Fluid
05.05.1013	100mm	1000579118AM	---	---	---	---	 Brake Fluid
05.05.1014	80mm	1000396262AM	---	---	---	---	 Brake Fluid
05.05.1015	80mm	1000434990AM	---	---	---	---	 Brake Fluid
05.62.8277	80mm	622500 626708	EKKO.25.2	EKKO.25.31	---	---	 Brake Fluid
		622501 626642	EKKO.25.2	---	---		
		626785 626786 628276 628277	EKKO.25.19	---	EKKO.25.34		
05.62.8258	100mm	627667 628258	EKKO.25.21	EKKO.25.33	EKKO.25.34	---	 Brake Fluid
05.62.8260	100mm	627669 628260	EKKO.25.21	EKKO.25.33	EKKO.25.34	---	 Brake Fluid
---	100mm	625067 626871 628446	EKKO.25.21	EKKO.25.33	---	---	 Brake Fluid

CLUTCH SERVOS - KONGSBERG - DAF							
EBS Part No	Diameter	Kongsberg Part No	Repair Kit - Main	Repair Kit - Air Valve	Repair Kit - Spool Assy	Repair Kit	Image
05.62.8448	100mm	627579 627668 628259 628448	EKKO.25.25	EKKO.25.33	---	---	 Brake Fluid
			EKKO.25.21				
05.62.8449	100mm	627589 628449	EKKO.25.21	EKKO.25.33	---	---	 Brake Fluid
05.62.8450	100mm	622508 626400 625111 626784 625810 626869 626580 626783 628275 628450	EKKO.25.7	EKKO.25.31	---	EKKO.25.33	 Brake Fluid
			EKKO.25.21				
			EKKO.25.21	---	EKKO.25.34		
			EKKO.25.24	EKKO.25.31			
05.62.9134	100mm	629134	EKKO.25.21	---	---	---	 Brake Fluid
05.62.9135	100mm	629135	EKKO.25.21	---	---	---	 Brake Fluid

CLUTCH SERVOS - KONGSBERG - ERF							
EBS Part No	Diameter	Kongsberg Part No	Repair Kit - Main	Repair Kit	Repair Kit	Repair Kit	Image
05.62.6693	80mm	626693	EKKO.25.2	---	---	---	 Brake Fluid

CLUTCH SERVOS - KONGSBERG - FODEN							
EBS Part No	Diameter	Kongsberg Part No	Repair Kit - Main	Repair Kit - Air Valve	Repair Kit	Repair Kit	Image
05.62.5671	100mm	625671	EKKO.25.21	EKKO.25.33	---	---	
05.62.6397	80mm	626397 629479	EKKO.25.2	---	---	---	 Brake Fluid
05.62.9479	80mm	629479AM	EKKO.25.22	---	---	---	 Brake Fluid

CLUTCH SERVO & CONTROL

CLUTCH SERVOS - KONGSBERG - FORD

EBS Part No	Diameter	Kongsberg Part No	Repair Kit - Main	Repair Kit	Image
05.05.1002	100mm	1000274399AM	---	---	 Brake Fluid
05.05.1010	100mm	1000349603AM	---	---	 Brake Fluid





CLUTCH SERVOS - KONGSBERG - ISUZU

EBS Part No	Diameter	Kongsberg Part No	Repair Kit - Main	Repair Kit	Image
05.62.5559	100mm	625559AM	---	---	 Brake Fluid

CLUTCH SERVOS - KONGSBERG - LEYLAND

EBS Part No	Diameter	Kongsberg Part No	Repair Kit - Main	Repair Kit	Image
05.62.6397	80mm	626397 629479	EKKO.25.2	---	 Brake Fluid
05.62.7497	80mm	624652 625290 626104 627497 627499	EKKO.25.2	---	 Brake Fluid
05.62.7498	80mm	627498AM 1000332424AM	EKKO.25.2	---	 Brake Fluid

CLUTCH SERVOS - KONGSBERG - MAN

EBS Part No	Diameter	Kongsberg Part No	Repair Kit - Main	Repair Kit	Image
05.62.5436	100mm	625436AM 628027	EKKO.25.20	---	 Brake Fluid
05.62.5586	100mm	622402	EKKO.25.7	---	 Brake Fluid
		625586	EKKO.25.21		
05.62.6162	100mm	622206 625385	EKKO.25.7	---	 Brake Fluid
		626162 625524	EKKO.25.22		
05.63.0361	100mm	630361AM	---	---	 Mineral Oil

CLUTCH SERVOS - KONGSBERG - MERCEDES					
EBS Part No	Diameter	Kongsberg Part No	Repair Kit - Main	Repair Kit - Sensor	Image
05.62.5375	100mm	625375	EKKO.25.28	30.10.0002A	 Brake Fluid
05.62.9184	100mm	629184AM	---	---	 Mineral Oil



CLUTCH SERVOS - KONGSBERG - RENAULT					
EBS Part No	Diameter	Kongsberg Part No	Repair Kit - Main	Repair Kit - Air Valve	Image
05.05.1005	100mm	1000139593	EKKO.25.22	---	 Brake Fluid
05.05.1006	100mm	1000129485	EKKO.25.22	---	 Brake Fluid
05.05.1008	80mm	1000479403AM	---	---	 Brake Fluid
05.62.7612	100mm	627612 624445	EKKO.25.22	EKKO.25.22A	 Brake Fluid
05.62.8277	80mm	625290 628276 628277	EKKO.25.2	---	 Brake Fluid
		626853	EKKO.25.33		
05.62.9300	100mm	629300	EKKO.25.22	EKKO.25.22A	 Brake Fluid
05.63.0424	100mm	630424AM	---	---	 Brake Fluid

CLUTCH SERVO & CONTROL

CLUTCH SERVOS - KONGSBERG - SCANIA

EBS Part No	Diameter	Kongsberg Part No	Repair Kit - Main	Repair Kit - Air Valve	Repair Kit - Spool Assy	Fitting Kit	Image
05.05.1009	100mm	1000409870	---	---	---	---	 Brake Fluid
05.62.2109	100mm	622109 622107	EKKO.25.6	---	---	---	 Brake Fluid
05.62.2190	100mm	622190	EKKO.25.15	EKKO.25.30	EKKO.25.12	---	 Brake Fluid
05.62.2199	100mm	622199	EKKO.25.15	EKKO.25.30	---	EKKO.25.13	 Brake Fluid
		622108	EKKO.25.7	---	EKKO.25.12		
05.62.4199	100mm	624199	EKKO.25.15	EKKO.25.30	EKKO.25.12	EKKO.25.13	 Brake Fluid
05.62.7946A	125mm	627946 1000178631	EKKO.25.35	---	---	---	 Brake Fluid
05.62.8554	100mm	628554 1000184461	---	---	---	---	 Brake Fluid
05.62.9683	100mm	625359 629683	EKKO.25.1	---	---	EKKO.25.EP	 Brake Fluid
		627692	EKKO.25.27	---	---		

CLUTCH SERVOS - KONGSBERG - VOLVO

EBS Part No	Diameter	Kongsberg Part No	Repair Kit - Main	Repair Kit - Boot & Plate	Repair Kit - Exhaust	Image
05.62.6392	80mm	622080	EKKO.25	---	---	 Brake Fluid
		626392	EKKO.25.16	---	---	
05.62.6639	95mm	622070 628045	EKKO.25.8 OR EKKO.25.18	---	---	 Brake Fluid
		626639	EKKO.25.26	---	---	
05.62.8494	100mm	627805 628494	EKKO.25.20	EKKO.25.32	---	 Brake Fluid
05.62.9276	100mm	626119 627803 628492 629276	EKKO.25.20	EKKO.25.32	EKKO.25.36	 Brake Fluid
05.62.9277	100mm	627208 627804 628493 629277	EKKO.25.20	EKKO.25.32	EKKO.25.36	 Brake Fluid
05.63.0889	100mm	630889AM	---	---	---	 Brake Fluid
05.05.1000	100mm	1000132951AM	---	---	---	 Brake Fluid
05.05.1001	100mm	1000133152AM	---	---	---	 Brake Fluid
05.05.1011	100mm	1000443286AM	EKKO.25.37	---	---	 Brake Fluid
05.05.1012	100mm	1000443297AM	EKKO.25.37	---	---	 Brake Fluid

CLUTCH SERVO & CONTROL

CLUTCH SERVOS - WABCO

							
Wabco Part No	4700511020	4700511040	4700511080	4700511090	Wabco Part No	4700511140	
Repair Kit	EKWA.28				Repair Kit	EKWA.28	
05.01.1102		05.01.1107		05.01.1111		05.01.1114	
							
Wabco Part No	9700511020	Wabco Part No	9700511070	Wabco Part No	9700511110	Wabco Part No	9700511140
Repair Kit	EKWA.28.4	Repair Kit	EKWA.28.10	Repair Kit	EKWA.28.4	Repair Kit	EKWA.28.4
05.01.1124		05.01.1126		05.01.1127		05.01.1128	
							
Wabco Part No	9700511240	Wabco Part No	9700511260	Wabco Part No	9700511270	Wabco Part No	9700511280
Repair Kit	EKWA.28.10	Repair Kit	EKWA.28.4	Repair Kit	EKWA.28.10	Repair Kit	EKWA.28.10
05.01.1129		05.01.1131		05.01.1132		05.01.1135	
							
Wabco Part No	9700511290	Wabco Part No	9700511310	Wabco Part No	9700511320	Wabco Part No	9700511350
Repair Kit	EKWA.28.4	Repair Kit	EKWA.28.3 EKWA.28.3A	Repair Kit	EKWA.28.10	Repair Kit	EKWA.28.4
05.01.1136		05.01.1137		05.01.1150		05.01.1151	
							
Wabco Part No	9700511360	Wabco Part No	9700511370	Wabco Part No	9700511500	Wabco Part No	9700511510
Repair Kit	EKWA.28.4	Repair Kit	EKWA.28.4	Repair Kit	EKWA.28.4	Repair Kit	EKWA.28.17

CLUTCH SERVOS - WABCO

05.01.1152		05.01.1154		05.01.1157		05.01.1158	
							
Wabco Part No	9700511520	Wabco Part No	9700511540	Wabco Part No	9700511570	Wabco Part No	9700511580
Repair Kit	EKWA.28.10	Repair Kit	EKWA.28.10	Repair Kit	EKWA.28.10	Repair Kit	EKWA.28.12
05.01.1159		05.01.1163		05.01.1164		05.01.1168	
							
Wabco Part No	9700511590	Wabco Part No	9700511630	Wabco Part No	9700511640	Wabco Part No	9700511680
Repair Kit	EKWA.28.12	Repair Kit	EKWA.28.10	Repair Kit	EKWA.28.8	Repair Kit	EKWA.28.10
05.01.1169		05.01.1171		05.01.1174		05.01.1176	
							
Wabco Part No	9700511690	Wabco Part No	9700511710	Wabco Part No	9700511740	Wabco Part No	9700511760
Repair Kit	EKWA.28.4	Repair Kit	EKWA.28.10	Repair Kit	EKWA.28.10	Repair Kit	EKWA.28.10
05.01.1179		05.01.1181		05.01.1182		05.01.1183	
							
Wabco Part No	9700511790	Wabco Part No	9700511810	Wabco Part No	9700511820	Wabco Part No	9700511830
Repair Kit	EKWA.28.8	Repair Kit	EKWA.28.10	Repair Kit	EKWA.28.10	Repair Kit	EKWA.28.4
05.01.1190		05.01.1191		05.01.1443		05.62.6639	
							
Wabco Part No	9700511900	Wabco Part No	9700511910	Wabco Part No	9700514430	Wabco Part No	9700511920
Repair Kit	EKWA.28.17	Repair Kit	EKWA.28.10	Repair Kit	EKWA.28.9B	Repair Kit	EKWA.28.10

CLUTCH SERVOS - WABCO

05.62.2109		05.62.6392		05.01.1204		05.01.1205	
Wabco Part No	9700511930	Wabco Part No	9700511940	Wabco Part No	9700512040	Wabco Part No	9700512050
Repair Kit	EKWA.28.10	Repair Kit	EKWA.28.10	Repair Kit	EKWA.28.10 or EKWA.28.16	Repair Kit	EKWA.28.10
05.01.1209		05.01.1217		05.01.1218		05.01.1220	
Wabco Part No	9700512090	Wabco Part No	9700512170	Wabco Part No	9700512180	Wabco Part No	9700512200
Repair Kit	EKWA.28.10 or EKWA.28.16	Repair Kit	EKWA.28.10	Repair Kit	EKWA.28.10	Repair Kit	EKWA.28.4
05.01.1224		05.01.1307		05.01.1402		05.01.1405	
Wabco Part No	9700512240	Wabco Part No	9700513070	Wabco Part No	9700514020	Wabco Part No	9700514050
Repair Kit	EKWA.28.10	Repair Kit	EKWA.28.9, EKWA.28.9B or 30.10.0002A	Repair Kit	EKWA.28.24 or EKWA.28.9B	Repair Kit	EKWA.28.19
05.01.1406		05.01.1407		05.01.1412		05.01.1413	
Wabco Part No	9700514060	Wabco Part No	9700514070	Wabco Part No	9700514120	Wabco Part No	9700514130
Repair Kit	EKWA.28.20	Repair Kit	EKWA.28.9 or 30.10.0002A	Repair Kit	EKWA.28.23 or EKWA.28.9B	Repair Kit	EKWA.28.9
05.01.1414		05.01.1415		05.01.1419		05.01.1422	
Wabco Part No	9700514140	Wabco Part No	9700514150	Wabco Part No	9700514190	Wabco Part No	9700514220
Repair Kit	EKWA.28.24 or EKWA.28.9B	Repair Kit	EKWA.28.25 or EKWA.28.9B	Part No	EKWA.28.24 or EKWA.28.9B	Repair Kit	EKWA.28.24 or EKWA.28.9B

CLUTCH SERVOS - WABCO

05.01.1423		05.01.1424		05.01.1429		05.01.1430	
							
Wabco Part No	9700514230	Wabco Part No	9700514240	Wabco Part No	9700514290	Wabco Part No	9700514300
Repair Kit	EKWA.28.4 or EKWA.28.9B	Repair Kit	EKWA.28.24 or EKWA.28.9B	Repair Kit	EKWA.28.26 or EKWA.28.9B	Repair Kit	EKWA.28.26 or EKWA.28.9B
05.01.1431		05.01.1432		05.01.1435		05.01.1436	
							
Wabco Part No	9700514310	Wabco Part No	9700514320	Wabco Part No	9700514350	Wabco Part No	9700514360
Repair Kit	EKWA.28.22	Repair Kit	EKWA.28.26 or EKWA.28.9B	Repair Kit	EKWA.28.26 or EKWA.28.9B	Repair Kit	EKWA.28.22
05.01.1437		05.01.1438		05.01.1439		05.01.1441	
							
Wabco Part No	9700514370	Wabco Part No	9700514380	Wabco Part No	9700514390	Wabco Part No	9700514410
Repair Kit	EKWA.28.9 or EKWA.28.9B	Repair Kit	EKWA.28.24 or EKWA.28.9B	Repair Kit	EKWA.28.24 or EKWA.28.9B	Repair Kit	EKWA.28.19
05.01.1451		05.01.1454		05.01.1465		05.01.1466	
							
Wabco Part No	9700514510	Wabco Part No	9700514540	Wabco Part No	9700514650	Wabco Part No	9700514660
Repair Kit	EKWA.28.20	Repair Kit	EKWA.28.24 or EKWA.28.9B	Repair Kit	EKWA.28.23 or EKWA.28.9B	Repair Kit	EKWA.28.23 or EKWA.28.9B
05.01.1601		05.01.2028		05.01.2034		05.01.4001	
							
Wabco Part No	9700516010	Wabco Part No	9701900280	Wabco Part No	9701900340	Wabco Part No	9740100010
Repair Kit	EKWA.28.32	Repair Kit	EKCD.6		Repair Kit	EKWA.28.30	

CLUTCH SERVO & CONTROL

CLUTCH SERVOS - WABCO

05.01.5001		05.01.10001		N16421768	
					
Wabco Part No	9701500010	Wabco Part No	9700520010	Wabco Part No	1642176808
Repair Kit	EKWA.28.31	Repair Kit	---	Repair Kit	EKWA.27



CLUTCH SERVOS - BENDITALIA / CLAYTON / DIMETAL / HALDEX / HINO / HYUNDAI / KRAZ / MITSUBISHI / NISSAN / PEGASO & OTHERS

EBS Part No	Alternative Part No	Repair Kit	Repair Kit	Image	
---	1408320 1408387 1408824 1409260 1409284	1409285 1409287 1409870 1420879	EKBI.2	---	
05.06.1000	1420362		EKBI.3.C2	---	
05.06.1002	1424371		EKBI.3.C2	---	
---	1406643 1407023 1407118		EKBI.1	---	
---	1409284		EKBI.3.C	---	
05.06.1001	1422762		EKBI.3.C	---	
---	1423079 1426591		EKBI.3.C3	---	
05.09.1605	APGA1605		EKCD.6.C	EKCD.6	
05.09.1608	APGA1608		EKCD.6.C	EKCD.6	
05.09.1610	APGA1610		EKCD.6.C	EKCD.6	
05.09.1611	APGA1611		EKCD.6.C	EKCD.6	
05.09.1613	APGA1613		EKCD.6.C	EKCD.6	
05.09.1617	APGA1617		EKCD.6.C	EKCD.6	
05.09.1632	APGA1632		EKCD.6.C	EKCD.6	
05.09.1633	APGA1633		EKCD.6.C	EKCD.6	
---	460.806		EKDI.28.1D	---	
N4608067	460.8067 5430000717		EKDI.28.1D	---	
---	460.807		EKDI.28.1D	---	
---	460.808		EKDI.28.1D	---	

CLUTCH SERVOS - BENDITALIA / CLAYTON / DIMETAL / HALDEX / HINO / HYUNDAI / KRAZ / MITSUBISHI / NISSAN / PEGASO & OTHERS

EBS Part No	Alternative Part No	Repair Kit	Repair Kit	Image
05.03.1000	321019001	EKGH.28.1	---	
05.03.1001	321023001	EKGH.28.1	---	
05.03.1005	321030001	---	---	
05.03.1003	321025001	---	---	
N64201608	642.01608 (70mm)	ECJK.28.1	---	
---	642.03080 (70mm)	ECJK.28.1	---	
N64203502	642.03502 (90mm)	ECJK.28	---	
N64203505	642.03105 (105mm)	ECJK.28.2	---	

CLUTCH SERVOS - BENDITALIA / CLAYTON / DIMETAL / HALDEX / HINO / HYUNDAI / KRAZ / MITSUBISHI / NISSAN / PEGASO & OTHERS

EBS Part No	Alternative Part No	Repair Kit	Repair Kit	Image
05.11.1001	11.1602410-01	---	---	
05.11.1010	11.1602410-10	---	---	
05.11.1020	11.1602410-20	---	---	
05.11.1032	11.1602410-32	---	---	
05.11.1040	11.1602410-40	---	---	

CLUTCH SERVO & CONTROL

CLUTCH ACTUATORS - KNORR BREMSE

R05.02.2874 05.02.2727*		R05.02.2875 05.02.2875		05.02.2858	
Alternative Part No	K015874 K013727N50* 0483005011100	Alternative Part No	K015875 K015875N50	Alternative Part No	K019858N50
Repair Kit	EKKB.25.75 EKKB.25.75C	Repair Kit	EKKB.25.75 EKKB.25.75C	Repair Kit	EKKB.25.75C

GEAR LEVER ACTUATORS - KONGSBERG - DAF

05.62.6261	
Brake Fluid	
Alternative Part No	626261
Repair Kit	---

GEAR LEVER ACTUATORS - KONGSBERG - MAN

05.62.7496	
Mineral Oil	
Alternative Part No	627496
Repair Kit	EKKO.25.96 EKKO.25.96C

GEAR LEVER ACTUATORS - KONGSBERG - MERCEDES

05.62.6321		05.62.6661		05.62.6662		05.62.9582	
Brake Fluid		Brake Fluid		Brake Fluid		Mineral Oil	
Alternative Part No	626321	Alternative Part No	626661	Alternative Part No	626662	Alternative Part No	629582 630767
Repair Kit	EKKO.25.95 EKKO.25.95C	Repair Kit	EKKO.25.95 EKKO.25.95C	Repair Kit	---	Repair Kit	---
05.62.9862		---		05.63.0388			
Mineral Oil		Mineral Oil		Mineral Oil			
Alternative Part No	629862	Alternative Part No	629978 630767	Alternative Part No	630388 630767		
Repair Kit	---	Repair Kit	---	Repair Kit	---		

ELECTROHYDRAULIC ACTUATOR - SCANIA

		S2CP10.055A	
Alternative Part No	S2CP10.057A		Brake Fluid
	10574929 10574930 10574936 1849429 1931444 2023059 2037304 2082082 2131963 2290706 2392193 2392281 2441305 2450508 574929 574944		
Repair Kit	EKPP.25		

GEAR LEVER ACTUATORS - VOLVO

Alternative Part No		Brake Fluid
Repair Kit	---	

PRESSURE SENSORS - KONGSBERG - MERCEDES

		30.05.2000	30.05.2001
Alternative Part No		Brake Fluid	
Repair Kit	---		

SHIFT CYLINDERS

MAN

		05.62.9218
Alternative Part No		Mineral Oil
Repair Kit	---	

MERCEDES

		05.62.6597
Alternative Part No		Brake Fluid
Repair Kit	---	

		05.62.6664
Alternative Part No		Brake Fluid
Repair Kit	---	

		05.62.7494
Alternative Part No		Brake Fluid
Repair Kit	---	

CLUTCH SERVO & CONTROL

SHIFT CYLINDERS

MERCEDES

05.62.9137		05.62.9920	
			
Mineral Oil		Mineral Oil	
Alternative Part No	629137AM	Alternative Part No	629920AM
Repair Kit	---	Repair Kit	---

ZF

05.41.1000		05.41.1001	
			
Alternative Part No	0501.211.290	Alternative Part No	0501.215.299
Repair Kit	---	Repair Kit	---

SELECT CYLINDERS

BOVA

05.62.6448	
	
Brake Fluid	
Alternative Part No	626448
Repair Kit	---

DAF

05.62.5942 05.62.5944	
	
Brake Fluid	
Alternative Part No	625942
Repair Kit	---

MAN

05.62.9218	
	
Mineral Oil	
Alternative Part No	629218AM
Repair Kit	---

05.62.9219	
	
Mineral Oil	
Alternative Part No	629219
Repair Kit	---

MERCEDES

05.62.6156		05.62.9303		05.62.9614		05.63.1355	
							
Brake Fluid		Mineral Oil		Brake Fluid		Mineral Oil	
Alternative Part No	626156	Alternative Part No	629303AM	Alternative Part No	629614	Alternative Part No	631355AM
Repair Kit	---	Repair Kit	---	Repair Kit	---	Repair Kit	---

GEAR SELECT CABLES - KONGSBERG

EBS Part No	Kongsberg Part No	Alternative Part No	Model	Cabin Type	Version	RHD / LHD	Length (mm)
05.05.5006	23197503186AM	81.32655-6311	MAN TGA/S/X	FH 640	L15-39	N/A	2844
05.05.5012	23197603252AM	81.32655-6322	MAN TGA/S/X	FH 640	L15-39	N/A	2920
05.05.5013	5001870062	---	RENAULT PREMIUM	---	---	---	3600
05.05.5014	5001870063	---	RENAULT PREMIUM	---	---	---	3630
05.05.5015	---	20475038	VOLVO	---	---	---	---
05.05.5003	5049001667AM	21343551	VOLVO	FM	D9/11+SR, S13+R	LHD	2890
05.05.5000	5049001668AM	21002852	VOLVO	FM	3060	LHD	3060
05.05.5004	5049001671AM	21343555	VOLVO	FM	D13+SR	LHD	2915
05.05.5001	5049001672AM	21002856	VOLVO	FM	3085	LHD	3085
---	5049001675AM	21343559	VOLVO	FM	Sparepart D12+SR	LHD	2940
---	5049001676AM	21002860	VOLVO	FM	3110	LHD	3110
05.05.5005	5049001683AM	21343565	VOLVO	FH	D13+SR	LHD	2650
05.05.5002	5049001684AM	21002866	VOLVO	FH	2750	LHD	2750
05.05.5010	5049001699AM	21343543 21789699	VOLVO	FM	D9/11+R	RHD	3950
---	5049001703AM	21343575	VOLVO	FM	D9/11+SR, D13+SR	RHD	3975
---	5049001704AM	21002876	VOLVO	FM	4015	RHD	4015
05.05.5008	5049001707AM	21343579	VOLVO	FM	D13+SR	RHD	4000
05.05.5009	5049001708AM	21002880	VOLVO	FM	4040	RHD	4040
---	5049001719AM	21343589	VOLVO	FH	D13+SR	RHD	4310
05.05.5007	5049001720AM	21002890	VOLVO	FH	4370	RHD	4370
05.05.5011	5049001730AM	20545996 20700996 21002896 21789730	VOLVO	FH	D16+SR	RHD	4470

CLUTCH SERVO & CONTROL



REPAIR KITS - KNORR BREMSE



REPAIR KITS - KONGSBERG

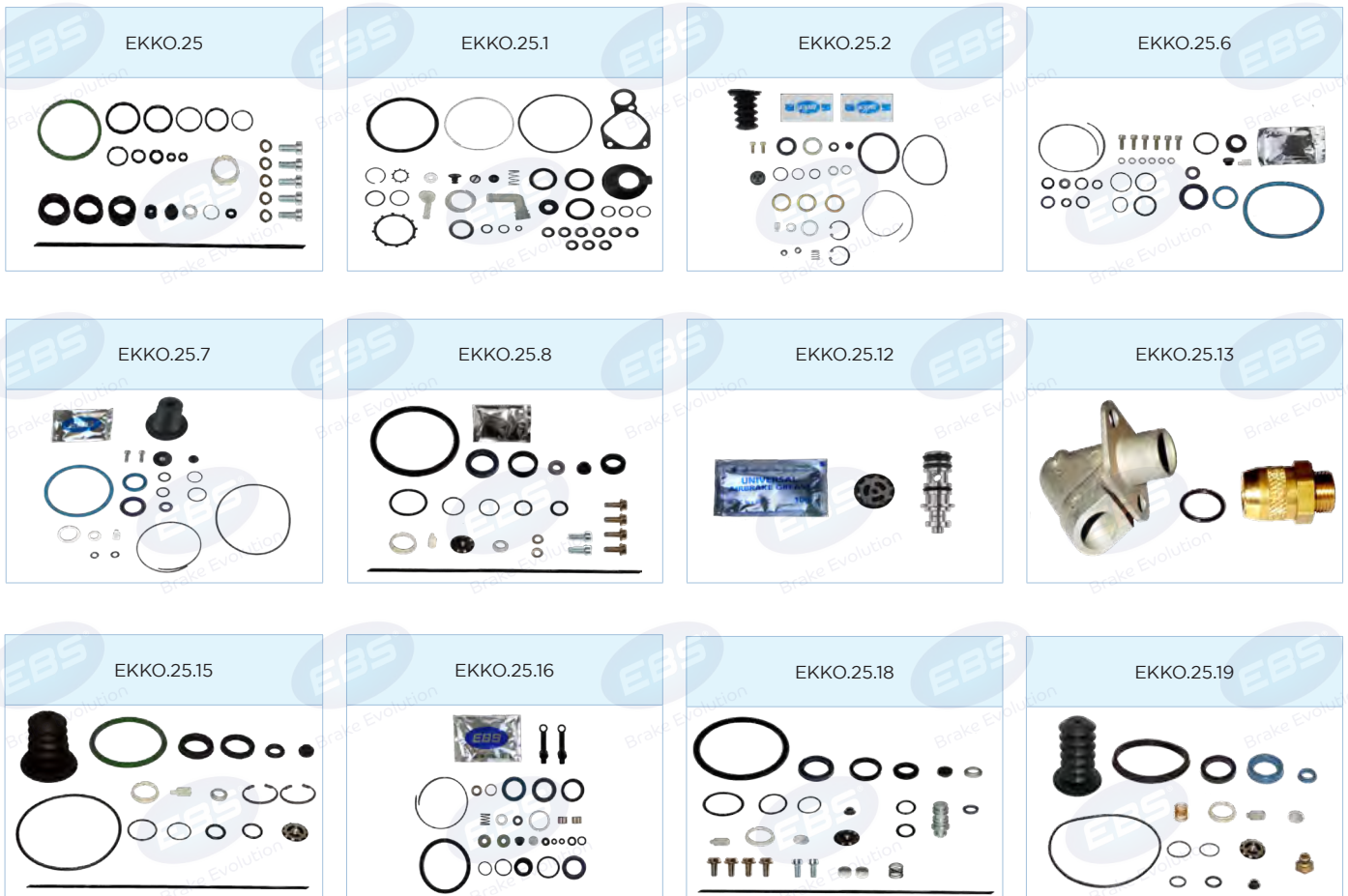

REPAIR KITS - KONGSBERG



CLUTCH SERVO & CONTROL

REPAIR KITS - VOLVO

EKKO.25.37

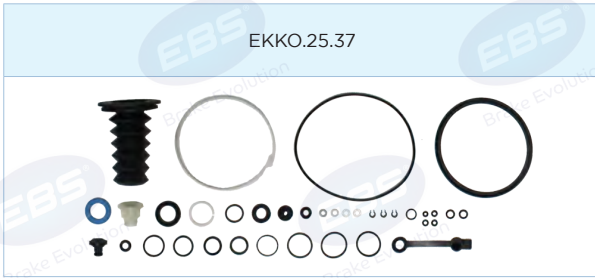

BOOT REPAIR KITS - WABCO

EKWA.28.A



BOOT KIT HOLE 15.7 - 6 SPIRES FOR 970.051.137

EKWA.28.B1



BOOT KIT HOLE 12 - 5 SPIRES FOR 970.051.102/107/124/127/128/151

EKWA.28.B2



BOOT KIT HOLE 8 FOR 970.051.114 / 126 & 377009 (Kongsberg)

EKWA.28.D



BOOT KIT HOLE 14 - 5 SPIRES FOR 470.051.102 / 109

EKCD.6



EKWA.27



EKWA.27.1



EKWA.27.4



EKWA.28



EKWA.28.3



EKWA.28.3A



EKWA.28.4



EKWA.28.8



EKWA.28.9



SEKWA.28.9



EKWA.28.9B



REPAIR KITS - WABCO

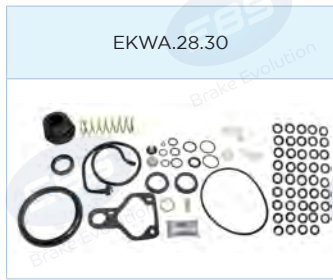
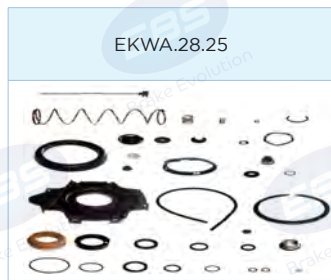

CLUTCH SERVO & CONTROL

REPAIR KIT ELECTROHYDRAULIC ACTUATOR - OTHERS

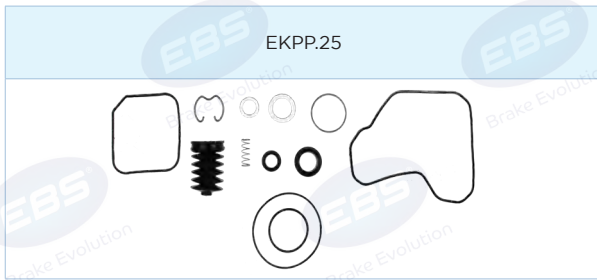

REPAIR KITS GEAR LEVER ACTUATORS - OTHERS



GEAR LEVER ACTUATORS - KNORR BREMSE



GEAR LEVER ACTUATORS - KONGSBERG - MAN



GEAR LEVER ACTUATORS - KONGSBERG - MERCEDES



CLUTCH SERVO & CONTROL

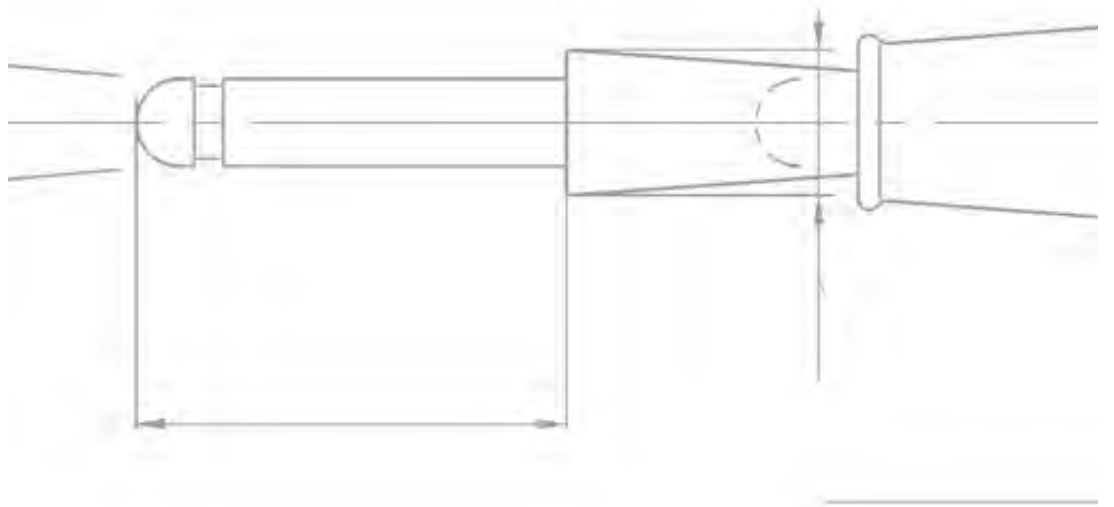
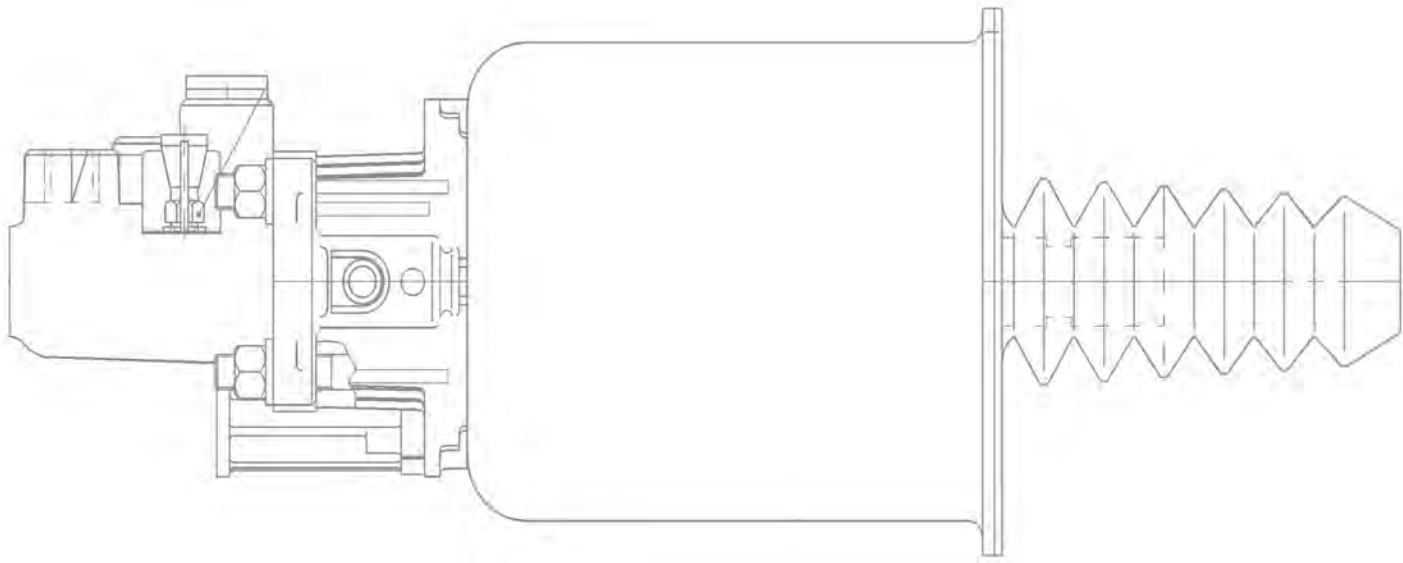

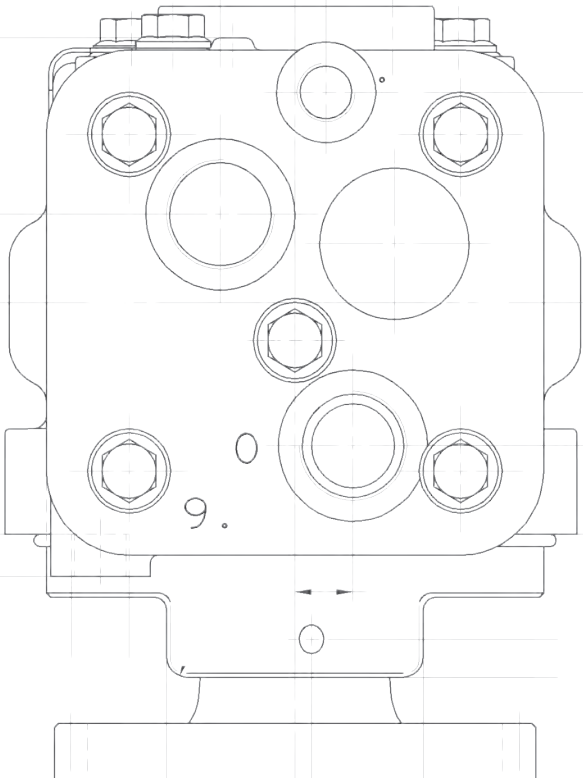
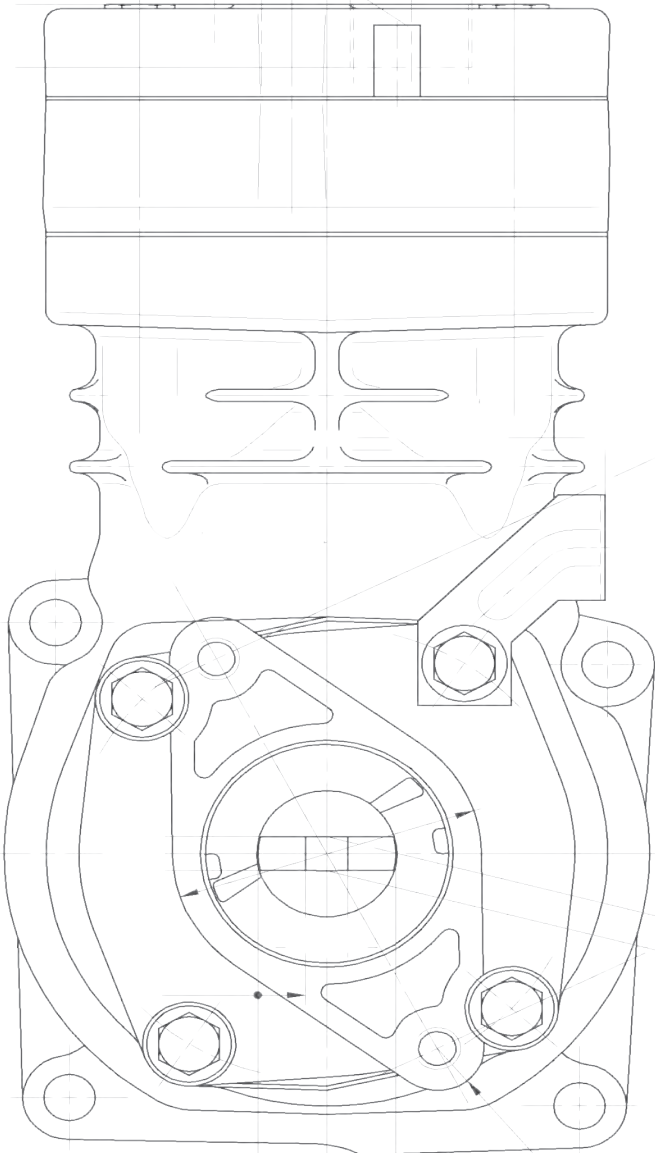

HALDEX COMPRESSORS

Alternative Part No



KNT86230

EKGH.6



KNORR SINGLE CYLINDER COMPRESSORS

Alternative Part No



1189499

EKKB.97.1

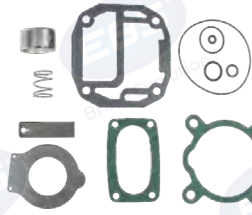

EKKB.97.CH



EKKB.97.CP



Alternative Part No



EKKB.9.R.STD



EKKB.9.RP.STD



EKKB.94



EKKB.94.CH



EKKB.94.IC

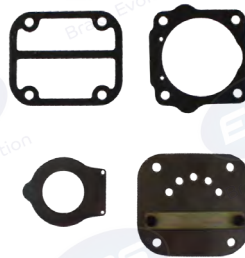

EKKB.94.CB



EKKB.94.CR



- | | | |
|--------|--------|--------|
| LK1300 | LK1521 | LK1553 |
| LK1303 | LK1522 | LK1559 |
| LK1304 | LK1523 | LK1560 |
| LK1305 | LK1524 | LK1561 |
| LK1314 | LK1525 | LK1566 |
| LK1325 | LK1527 | LK1567 |
| LK1327 | LK1532 | LK1568 |
| LK1500 | LK1533 | LK1585 |
| LK1503 | LK1534 | LK1587 |
| LK1504 | LK1535 | LK1588 |
| LK1506 | LK1537 | LK1596 |
| LK1511 | LK1539 | LP1527 |
| LK1517 | LK1543 | LP1537 |
| LK1518 | LK1545 | LP1567 |
| LK1519 | LK1550 | |
| LK1520 | LK1551 | |

KNORR SINGLE CYLINDER COMPRESSORS

<p>Alternative Part No</p> 	<p>EKKB.92.RP.STD (BOX CONTAINS TWO PISTONS AND RINGSET)</p> 	<p>EKKB.94.CR (FOR LK18 XX & LP18 XX)</p> 	<p>EKKB.95</p> 	
	<p>EKKB.95.CB (FOR LK1900/101/1907/ LP1959)</p> 	<p>EKKB.95.CH</p> 	<p>EKKB.95.CHO (FOR LK1802/LK1901/1907 LP1806/LP1959)</p> 	
	<p>EKKB.95.CR (FOR ALL LK19 Series)</p> 	<p>EKKB.95.1C</p> 	<p>EKKB.95.1CH (FOR LK1812/1814)</p> 	
	<p>EKKB.102.CB (FOR LK18 XX & LP1828/LP1806)</p> 	<p>EKKB.96.RP.STD (FOR LP1828)</p> 		

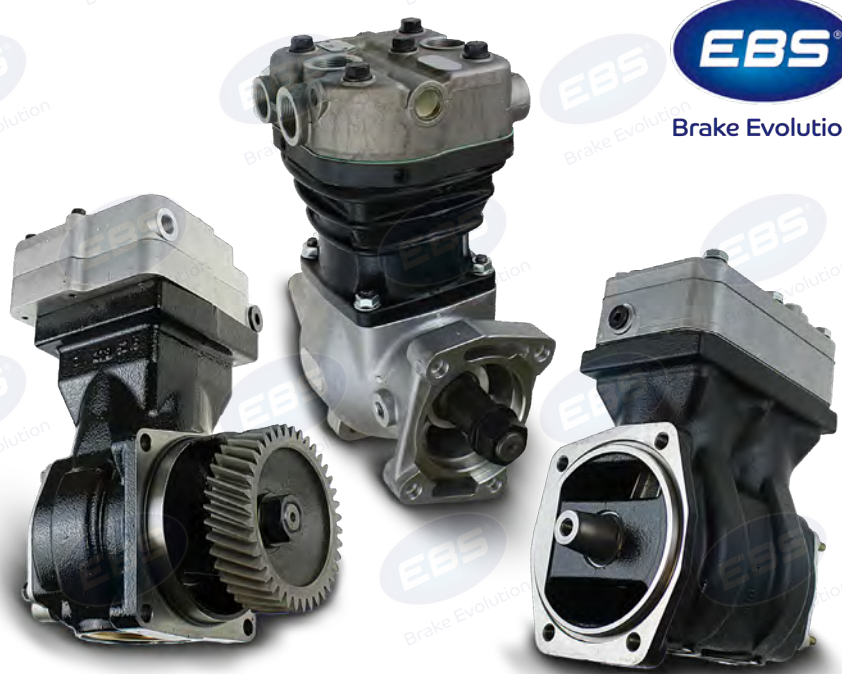

COMPRESSORS

ALL PISTON RINGS ARE AVAILABLE IN OVERSIZE ORDER RING SETS USING THIS RULE : (e.g. EK--.--.RP.STD = Standard size item.)
 e.g. EK--.--.RP.010= .010 oversize item./e.g. EK--.--.RP.020= .020 oversize item./e.g. EK--.--.RP.030= .030 oversize item./e.g. EK--.--.RP.040= .040 oversize item.

KNORR SINGLE CYLINDER COMPRESSORS



Alternative Part No	Image	Alternative Part No	Image
LK3802	1	LK3812	6
LK3826 LK3832 LK3868 LK3927	2	LK3914 LK3080	7
LK3963	3	LP3940	8
LP3993	4	LK3904	9
LK3908	5		



EKKB.92.RP.STD
(BOX CONTAINS TWO PISTONS AND RINGSET)

EKKB.94.CR
(FOR LK3802/LK3832/LK3914)

EKKB.95.CB

EKKB.95.CR

EKKB.99

EKKB.100

CRANK-GEAR9
(FOR LK3927)

EKKB.100.BU
(FOR LK3802 / LK3904)

EKKB.102.CB
(FOR LK3802)

EKKB.130

EKKB.427.5.CH

KNORR SINGLE CYLINDER COMPRESSORS

<p>Alternative Part No</p> 	<p>EKKB.92.RP.STD (BOX CONTAINS TWO PISTONS AND RINGSET)</p> 		<p>EKKB.94.CR (FOR LK18 XX & LP18 XX)</p> 	<p>EKKB.95.CR (FOR LK3972)</p> 
	<p>LK3813 LK3877 LK3970</p>	<p>LK3971 LK3972</p>	<p>EKKB.100</p> 	<p>EKKB.100.2</p> 
<p>EKKB.100.BU</p> 		<p>EKKB.102.CB (FOR LK3813/3877)</p> 		<p>EKKB.100.CH (FOR LK3813)</p> 

<p>Alternative Part No</p> 	<p>EKKB.92.RP.STD (BOX CONTAINS TWO PISTONS AND RINGSET)</p> 		<p>EKKB.95.CR (FOR LK3972)</p> 	<p>EKKB.100.BU</p> 
	<p>LK3963 LP3927 LP3813 LK3832</p>	<p>EKKB.100</p> 	<p>EKKB.100.1 (FOR LK3963)</p> 	<p>EKKB.100.3 (FOR LP3927)</p> 
<p>EKKB.100.CH (FOR LP3813-LK3832)</p> 		<p>EKKB.130</p> 		<p>EKKB.427.5.CH (FOR LK3963)</p> 

ALL PISTON RINGS ARE AVAILABLE IN OVERSIZE ORDER RING SETS USING THIS RULE : (e.g. EK---.---.RP.STD = Standard size item.)
 e.g. EK---.---.RP.010= .010 oversize item./e.g. EK---.---.RP.020= .020 oversize item./e.g. EK---.---.RP.030= .030 oversize item./e.g. EK---.---.RP.040= .040 oversize item.

COMPRESSORS

KNORR SINGLE CYLINDER COMPRESSORS

Alternative Part No

LK3501
LK3509
LK3510

EKKB.105

Alternative Part No

LK3833

EKKB.103.33.CH

Alternative Part No

LK3869

EKKB.114

EKKB.114.CH

EKKB.103.RP.STD

Alternative Part No

LK3930 LK3966
LK3940 LK3982
LK3965 LK3986

EKKB.94.CR
(FOR LK18 XX & LP18 XX)

EKKB.100.BU

EKKB.92.RP.STD
(BOX CONTAINS TWO PISTONS AND RINGSET)

EKKB.95.CR
(FOR LK3965)

EKKB.99

EKKB.99.CP

EKKB.99.CHO

Alternative Part No

LK3821
LK3842

EKKB.92.RP.STD
(BOX CONTAINS TWO PISTONS AND RINGSET)

EKKB.102

EKKB.102.CB

KNORR SINGLE CYLINDER COMPRESSORS

<p>Alternative Part No</p>  <p>LK3840 LK3846 LK3859 LK3857</p> <p>LK3841 LK3871 LK3875</p>	<p>EKKB.100.19</p> 	<p>EKKB.103</p> 	<p>EKKB.103.72</p> 	
	<p>EKKB.103.75</p> 	<p>EKKB.103.89.CH FOR LK3859</p> 	<p>EKKB.103.9</p> 	
	<p>EKKB.103.CHO</p> 	<p>EKKB.103.G</p> 	<p>EKKB.103.GB</p> 	
	<p>EKKB.103.RP.STD</p> 			
<p>Alternative Part No</p>  <p>LK8901 LP3997 LK3401</p>	<p>EKKB.106</p> 	<p>EKKB.106.CH</p> 	<p>EKKB.106.CP</p> 	
	<p>EKKB.9.2G.BU</p> 	<p>EKKB.106.CK</p> 	<p>EKKB.104.RP.STD</p> 	
<p>Alternative Part No</p>  <p>LK3994 LP3974 LP3977 LP3970</p>	<p>EKKB.110</p> 	<p>EKKB.110.CH (For LP3974 Only)</p> 	<p>EKKB.110.CP (For LP3974 Only)</p> 	
	<p>EKKB.9.2G.BU</p> 	<p>EKKB.104.RP.STD</p> 		

For the COMPLETE Valve Plate Assy for LK3994 & LP3977 please use: EKKB.100.4 & the Gaskets in EKKB.110

ALL PISTON RINGS ARE AVAILABLE IN OVERSIZE ORDER RING SETS USING THIS RULE : (e.g. EK---.---.RP.STD = Standard size item.)
e.g. EK---.---.RP.010= .010 oversize item./e.g. EK---.---.RP.020= .020 oversize item./e.g. EK---.---.RP.030= .030 oversize item./e.g. EK---.---.RP.040= .040 oversize item.

COMPRESSIONS

KNORR SINGLE CYLINDER COMPRESSORS

Alternative Part No		EKKB.91.R.STD	EKKB.91.RP.STD (NOT LP.3843)	EKKB.101
LP3830 LP3832 LP3833 LP3843	LP3857 LP3860 LP3861	EKKB.101.BU 	EKKB.101.CR 	

Alternative Part No		EKKB.9.2G.BU	EKKB.100.4	EKKB.104
LP3980 LP3986		EKKB.104.CH 	EKKB.104.RP.STD 	EKKB.106.CK

Alternative Part No		EKKB.10000	
K157264N00 LS3907		CYLINDER HEAD TO SUIT 06.02.3907// LS3907	K105789K50

KNORR CYLINDER HEAD	
EKKB.308.CH	
Alternatives	1189308
COMPLETE CYLINDER HEAD REPAIR KIT	

WABCO SINGLE CYLINDER COMPRESSORS

<p>Alternative Part No</p> 	<p>EKWA.95.R.STD</p> 	<p>EKWA.95.RP.STD</p> 	<p>EKWA.117</p> 
	<p>EKWA.119.CH</p> 	<p>4123520030 9121160000 9121170000</p>	

<p>Alternative Part No</p> 	<p>EKWA.95.R.STD</p> 	<p>EKWA.95.RP.STD</p> 	<p>EKWA.131.CH</p> 
	<p>EKWA.131</p> 	<p>EKWA.96.CR</p> 	<p>4123520040</p>

<p>Alternative Part No</p> 	<p>EKWA.95.R.STD</p> 	<p>EKWA.95.RP.STD</p> 	<p>EKWA.95.CR</p> 
	<p>EKWA.115</p> 	<p>EKWA.115.CH</p> 	<p>4123520050</p>

<p>Alternative Part No</p> 	<p>EKWA.95.R.STD</p> 	<p>EKWA.95.RP.STD</p> 	<p>EKWA.95.CR</p> 
	<p>EKWA.114</p> 	<p>EKWA.114.CH</p> 	<p>4123520060 4123520140 4123520070 4123520150 4123520090 4123520160 4123520100 4123520170 4123520110 4123520260 4123520130 4123520270</p>

ALL PISTON RINGS ARE AVAILABLE IN OVERSIZE ORDER RING SETS USING THIS RULE : (e.g. EK--.--RP.STD = Standard size item.)
e.g. EK--.--RP.010= .010 oversize item./e.g. EK--.--RP.020= .020 oversize item./e.g. EK--.--RP.030= .030 oversize item./e.g. EK--.--RP.040= .040 oversize item.

COMPRESSORS

WABCO SINGLE CYLINDER COMPRESSORS

Alternative Part No



4123520080
4123520200

EKWA.124.CH



EKWA.95.RP.STD



EKWA.124



Alternative Part No



4123520010
4123520020
4123520250

EKWA.95.R.STD



EKWA.116



EKWA.95.RP.STD



EKWA.116.CH



EKWA.95.CR



Alternative Part No



4110345010
4110345310

EKWA.92.A



EKWA.93



EKWA.93.3



EKWA.99.RP.STD



Alternative Part No



4111510000
4111530000

EKWA.103



EKWA.95.RP.STD



EKWA.103.RV



EKWA.96.CR



EKWA.95.R.STD



EKWA.160



WABCO SINGLE CYLINDER COMPRESSORS

Alternative Part No



4111510030 4111510040	4111540000 4111540030 4111510090
--------------------------	--

EKWA.95.R.STD



EKWA.104.CH



EKWA.95.RP.STD



EKWA.160.CH



EKWA.104



CRANK-GEAR5



Alternative Part No



9115140010 9115148002

EKWA.125.CH



Alternative Part No



9111530010 9111539202

EKWA.95.R.STD



EKWA.105



EKWA.95.RP.STD



EKWA.120.CH



EKWA.96.CR



EKWA.160



Alternative Part No



9111535100 9111535200 9111535300 9111535400	9111539360 9111539350 9111535330
--	--

EKWA.120



Alternative Part No



9110047250 9110048960

EKWA.122



ALL PISTON RINGS ARE AVAILABLE IN OVERSIZE ORDER RING SETS USING THIS RULE : (e.g. EK--.--.RP.STD = Standard size item.)
 e.g. EK--.--.RP.010= .010 oversize item./e.g. EK--.--.RP.020= .020 oversize item./e.g. EK--.--.RP.030= .030 oversize item./e.g. EK--.--.RP.040= .040 oversize item.

WABCO SINGLE CYLINDER COMPRESSORS

Alternative Part No



9111545130
9111545150
9111545160

EKWA.109



EKWA.121.CH



Alternative Part No



9111450500
9111450600

9111455000
9111455600

EKWA.101



Alternative Part No



4111410010
4111410000
4111410020
4111410050
4111410100

4111415000
4111415010
4111415030
4111415040

EKWA.100



EKWA.100.1



Alternative Part No

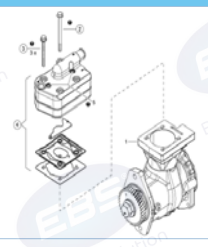

9111545130
9111545150
9111545160

EKWA.121



Alternative Part No



4111428180
4111428160
4111428050
4111428190

4111438050
4111436020
4111438440
4111438450

EKWA.99



EKWA.99.1



EKWA.99.RP.STD



EKWA.99.R.STD



Alternative Part No



9122100000

EKWA.126.1



EKWA.126.CH



KNORR TWIN CYLINDER COMPRESSORS



Alternative Part No

- KZ396/2
- KZ433/1
- KZ996/1
- KZ996/2
- KZ1228/1

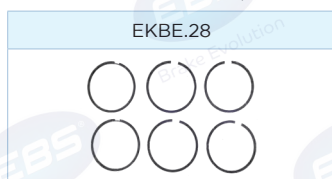
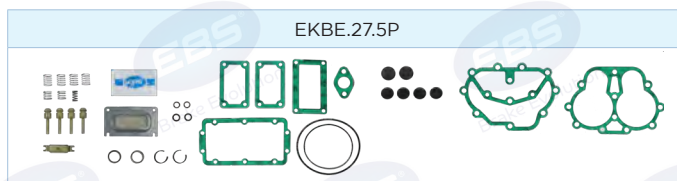

Repair Kits as above except

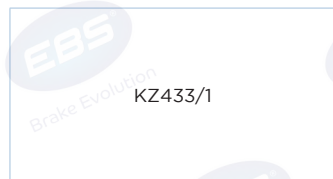

KZ433/1



KZ642/1



KZ996/1



KZ1087/4

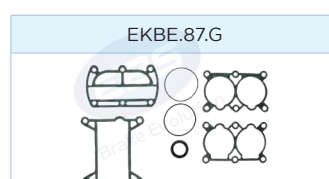
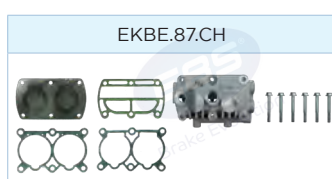

ALL PISTON RINGS ARE AVAILABLE IN OVERSIZE ORDER RING SETS USING THIS RULE : (e.g. EK-...-...-RP.STD = Standard size item.)
 e.g. EK-...-...-RP.010= .010 oversize item./e.g. EK-...-...-RP.020= .020 oversize item./e.g. EK-...-...-RP.030= .030 oversize item./e.g. EK-...-...-RP.040= .040 oversize item.

COMPRESSORS

KNORR TWIN CYLINDER COMPRESSORS

<p>Alternative Part No</p>	<p>EKKB.9.2F.CR</p>		<p>EKKB.9.2G</p>		<p>EKKB.9.2G.CH (FOR LK4920, LP4985)</p>	
	<p>LK4918 LK4919 LK4920 LK4921</p>	<p>LK4922 LP4985 LP4992</p>	<p>EKKB.9.2G.CR (FOR LK4921/LK4922)</p>		<p>EKKB.9.2G.BU</p>	<p>EKKB.9.3G.CH To suit LK4918</p>
<p>EKKB.122.2 (FOR LK4921)</p>		<p>EKKB.9.2G.CP</p>		<p>EKKB.130.5 (FOR LK..)</p>		
<p>EKKB.130.6 (FOR LP..)</p>		<p>SEKKB.9.2F</p>			<p>EKKB.92.R.STD</p>	

<p>Alternative Part No</p>	<p>EKKB.9.2F</p>		<p>EKKB.9.2F.CP</p>		<p>EKKB.9.2F.CH</p>		
	<p>LK4941 LP4965 LP4930 LP4934 LP4938 LP4949 LP4957 LP4960</p>	<p>LP4961 LP4963 LP4964 LP4966 LP4967 LP4968 LP4974</p>	<p>EKKB.130.4 (FOR LK4941/LP4965/LP4964/LP4966)</p>		<p>EKKB.130.3 (FOR LP4930/LP4974)</p>		<p>EKKB.130.2 (FOR LP4934/LP4960/LP4967/LP4968)</p>
<p>EKKB.130.7 (FOR LP4963)</p>		<p>EKKB.130.9 (FOR LP4938)</p>		<p>EKKB.9.2F.CR</p>			
<p>EKKB.9.2G.BU</p>		<p>EKKB.92.RP.STD (Box contains TWO Pistons & the Ring Set)</p>		<p>EKKB.92.R.STD</p>			
<p>SEKKB.9.2F</p>					<p>EKKB.9.2F.GS</p>		

KNORR TWIN CYLINDER COMPRESSORS

<p>Alternative Part No</p> 	<p>EKKB.9.2C</p> 	<p>EKKB.9.2C.CP</p> 	<p>EKKB.92 (FOR LP4812)</p> 
	<p>EKKB.131.1 (FOR LP4813)</p> 	<p>EKKB.131.2 FOR LP4814/LP4815/LP4844/ LP4852/LP4842)</p> 	<p>EKKB.9.2C.CR</p> 
	<p>EKKB.9.2G.BU</p> 	<p>EKKB.9.RP.STD</p> 	<p>EKKB.9.R.STD</p> 

<p>Alternative Part No</p> 	<p>EKKB.9.2E</p> 	<p>EKKB.123.1</p> 
	<p>EKKB.9.2E.CP</p> 	<p>EKKB.9.2C.CR</p> 
	<p>EKKB.9.2G.BU</p> 	<p>EKKB.9.RP.STD</p> 
<p>EKKB.120.2</p> 	<p>EKKB.122.1</p> 	<p>EKKB.131.3</p> 

<p>Alternative Part No</p> 	<p>EKKB.9.2D</p> 	<p>EKKB.9.2D.CP</p> 	<p>EKKB.131.4</p> 
	<p>EKKB.9.2C.CR</p> 	<p>EKKB.9.RP.STD</p> 	<p>EKKB.9.R.STD</p> 

ALL PISTON RINGS ARE AVAILABLE IN OVERSIZE ORDER RING SETS USING THIS RULE : (e.g. EK--.--.RP.STD = Standard size item.)
 e.g. EK--.--.RP.010= .010 oversize item./e.g. EK--.--.RP.020= .020 oversize item./e.g. EK--.--.RP.030= .030 oversize item./e.g. EK--.--.RP.040= .040 oversize item.

COMPRESSORS

KNORR TWIN CYLINDER COMPRESSORS

Alternative Part No



LK4935	LP4861	1194135
LK4936	LP4857	1194354
LK4937	LP4865	1194421
LK4952	LP4863	1194454
	LP4864	1194487

EKKB.9.2I

EKKB.9.2IA

EKKB.9.2IB

EKKB.9.2IC
(FOR LP4857 / LK4936)

EKKB.9.2IC.CH
(FOR K022263)

EKKB.9.2IF

EKKB.93.RP.STD

EKKB.9.2IE

EKKB.9.2IP.CH

EKKB.9.2I.CH
(1194135)

EKKB.9.2I.CP

EKKB.93.R.STD

Alternative Part No



LP4827
LP4845
LP4851
LP4855

EKKB.9.2G.BU

EKKB.9.2H

EKKB.9.2H.CP

EKKB.9.2H.CH

EKKB.9.2H.CR

EKKB.91.R.STD

EKKB.91.RP.STD

EKKB.131.6

EKKB.131.7

KNORR TWIN CYLINDER COMPRESSORS

COMPRESSORS

Alternative Part No



LP4871

EKKB.9.2ID

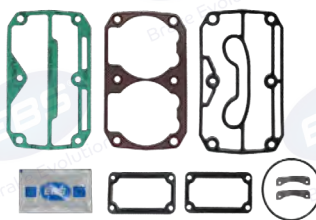

Alternative Part No



LK4911,
LK4931
LK4932
LK4939

EKKB.9.2L



EKKB.9.2L.CH

CYLINDER HEAD



EKKB.9.2L.CP

VALVE PLATE&GASKETS



EKKB.9.2L.PB

PISTON 7 BARREL



EKKB.92.RP.STD

(BOX CONTAINS TWO PISTONS AND RINGSET)



EKKB.9.2L.GB

GASKET & BOLTS

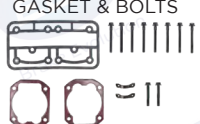

Alternative Part No



LK4928
LK4960

EKKB.9.2G.BU



EKKB.9.2N



EKKB.9.2N.CH



EKKB.9.2N.CP



EKKB.104.RP.STD



Alternative Part No



LK4934

EKKB.9.2G.BU



EKKB.104.RP



EKKB.108



EKKB.108.CH



EKKB.108.CP



ALL PISTON RINGS ARE AVAILABLE IN OVERSIZE ORDER RING SETS USING THIS RULE : (e.g. EK--.--.RP.STD = Standard size item.)
e.g. EK--.--.RP.010= .010 oversize item./e.g. EK--.--.RP.020= .020 oversize item./e.g. EK--.--.RP.030= .030 oversize item./e.g. EK--.--.RP.040= .040 oversize item.

KNORR TWIN CYLINDER COMPRESSORS

Alternative Part No

LK4945
LK4966

LK4968
LK4972

EKKB.9.2M

EKKB.9.2G.BU

EKKB.9.2M.CH

EKKB.9.2M.CP

EKKB.9.2R

EKKB.9.2R.ESS

FOR LK4972

EKKB.93.R.STD

EKKB.93.RP.STD

Alternative Part No

LK4951

EKKB.9.2G.BU

EKKB.93.R.STD

EKKB.93.RP.STD

EKKB.109.C

EKKB.109.CH

EKKB.109.CP

EKKB.109.TC

Alt. part: K018810

Alternative Part No

LK4970, LK4949
K038653N00

EKKB.109

EKKB.109.C

EKKB.109.CH

KNORR TWIN CYLINDER COMPRESSORS

Alternative Part No



LK4930
LK4944
LK4954

EKKB.9.2K



EKKB.9.2K.CH
(For LP4944/LP4954)



EKKB.9.3K.CH
(For LK4930)



EKKB.104.RP.STD



EKKB.9.2G.BU



Alternative Part No



LK8907
K162503N00

EKKB.104.RP.STD



EKKB.10001
CYLINDER HEAD



EKKB.10002
REPAIR KIT (VALVE PLATE)



EKKB.10003
REPAIR KIT (VALVES & GASKETS)



Alternative Part No



LP4832
LP4940
LP4942
LP4943
LP4944

1013383000
1013393000

EKPD.8



EKPD.8.R.STD



EKPD.8.RP.STD
(For LP4943/1013383000/1013393000)



EKKB.70.R.STD
(For LP4832/LP4840/LP4842/LP4944)



EKKB.70.RP.STD
(For LP4832/LP4840/LP4842/LP4944)



ALL PISTON RINGS ARE AVAILABLE IN OVERSIZE ORDER RING SETS USING THIS RULE : (e.g. EK--.--RP.STD = Standard size item.)
e.g. EK--.--RP.010= .010 oversize item./e.g. EK--.--RP.020= .020 oversize item./e.g. EK--.--RP.030= .030 oversize item./e.g. EK--.--RP.040= .040 oversize item.

COMPRESSIONS

WABCO TWIN CYLINDER COMPRESSORS

Alternative Part No



4127040000	4127040140
4127040070	4127040150
4127040120	4127040160
4127040130	

EKKB.9.2G.BU



EKWA.95.CR



EKWA.95.R.STD



EKWA.95.RP.STD



EKWA.108.1



EKWA.108.1CH



EKWA.108.BF



Alternative Part No



4127040190

EKWA.109.CH

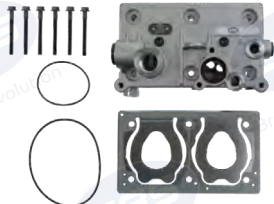

Alternative	4127049372
-------------	------------

Alternative Part No



4127040180
4127040270

EKKB.9.2G.BU



EKWA.95.CR



EKWA.95.R.STD



EKWA.95.RP.STD



EKWA.108.3

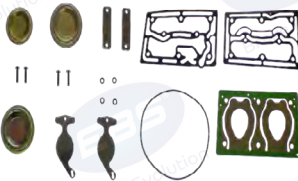

EKWA.108.2







EKWA.108.BF



WABCO TWIN CYLINDER COMPRESSORS

<p>Alternative Part No</p>  <p>4127040010 4127040040 4127040050 4127040080</p>	<p>EKKB.9.2G.BU</p> 	<p>EKWA.95.RP.STD</p> 	<p>EKWA.95.CR</p> 
	<p>EKWA.108</p> 	<p>EKWA.108.CH</p> 	<p>EKWA.140</p> 
	<p>EKWA.108.BF</p> 	<p>EKWA.108.CP</p> 	

<p>Alternative Part No</p>  <p>411553000</p>	<p>EKKB.9.2G.BU</p> 	<p>EKWA.9.7</p> 	<p>EKWA.9.7CH</p> 
	<p>EKWA.95.R.STD</p> 	<p>EKWA.95.RP.STD</p> 	<p>EKWA.96.CR</p> 

<p>Alternative Part No</p>  <p>4115530010 4115530030</p>	<p>EKWA.9.2.CH</p> 	<p>EKKB.9.2G.BU</p> 	<p>EKWA.95.R.STD</p> 
	<p>EKWA.95.RP.STD</p> 	<p>EKWA.96.CR</p> 	<p>EKWA.113</p> 

ALL PISTON RINGS ARE AVAILABLE IN OVERSIZE ORDER RING SETS USING THIS RULE : (e.g. EK--.--RP.STD = Standard size item.)
e.g. EK--.--RP.010= .010 oversize item./e.g. EK--.--RP.020= .020 oversize item./e.g. EK--.--RP.030= .030 oversize item./e.g. EK--.--RP.040= .040 oversize item.

COMPRESSORS

WABCO TWIN CYLINDER COMPRESSORS

Alternative Part No	Alternative Part No	Alternative Part No
4124420000	4124420010	9115045060



Alternative Part No
4126360000 4126360010 4126360030
9115530000 9115530010 9115530030 9115530070

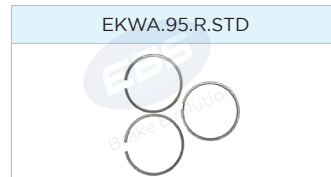
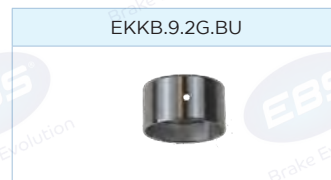
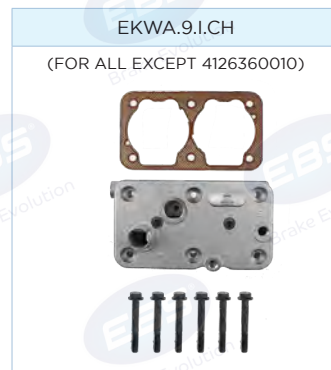

WABCO TWIN CYLINDER COMPRESSORS

Alternative Part No



9111555140

EKWA.111



Alternative Part No



9115010100
9115010110
9115010160
9115010550

9115010560
9115010590
9115010620

Alternative Part No



9115010600
9115010610

EKWA.9.C



EKWA.9.D



EKWA.95.R.STD



EKWA.95.RP.STD



EKWA.108.BU



Alternative Part No



9115011510
9115051500
9115051510

EKWA.95.C



EKWA.95.CR



EKWA.95.R.STD



EKWA.95.RP.STD



EKWA.108.BU



EKWA.123.14



ALL PISTON RINGS ARE AVAILABLE IN OVERSIZE ORDER RING SETS USING THIS RULE : (e.g. EK--.--.RP.STD = Standard size item.)
e.g. EK--.--.RP.010= .010 oversize item./e.g. EK--.--.RP.020= .020 oversize item./e.g. EK--.--.RP.030= .030 oversize item./e.g. EK--.--.RP.040= .040 oversize item.

COMPRESSORS

WABCO TWIN CYLINDER COMPRESSORS

Alternative Part No



9115040520

EKKB.9.2G.BU



EKWA.90.C



EKWA.90.RP.STD



EKWA.90.CR



EKWA.90.CP



EKWA.131.7



Alternative Part No



9115045000
9115045010
9115045020
9115045030

EKWA.9.E



EKWA.9.E.CH



EKWA.95.CR



EKWA.90.RP.STD



Alternative Part No



9115040560
9115040600

EKWA.9.F



EKWA.95.CR



EKWA.9.F.CH



EKWA.95.R.STD



EKKB.9.2G.BU



EKWA.95.RP.STD



Alternative Part No



9115060540

EKWA.9.G

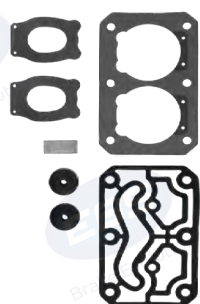

WABCO TWIN CYLINDER COMPRESSORS

Alternative Part No



9115065000
9115065040

EKWA.9.K

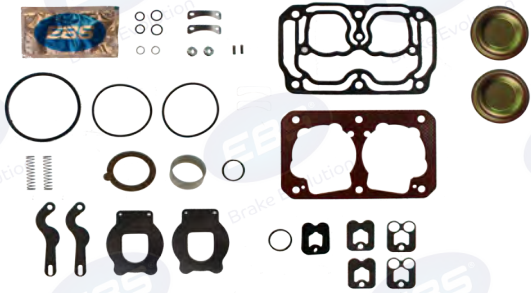

Alternative Part No



9115150010 9115150080
9115150030 9115150090

EKWA.9.11



Alternative 9115159232

EKWA.9.11.CH



Alternative 9115159212

Alternative Part No



9115160100

EKWA.9.10



EKWA.9.10.CH



EKWA.90.RP.STD



Alternative Part No



9115532000

Alternative Part No



9115532030

EKWA.9.L



EKWA.90.CR



EKWA.9.L.CH



EKWA.90.RP.STD



ALL PISTON RINGS ARE AVAILABLE IN OVERSIZE ORDER RING SETS USING THIS RULE : (e.g. EK--.--RP.STD = Standard size item.)
e.g. EK--.--RP.010= .010 oversize item./e.g. EK--.--RP.020= .020 oversize item./e.g. EK--.--RP.030= .030 oversize item./e.g. EK--.--RP.040= .040 oversize item.

COMPRESSORS

WABCO TWIN CYLINDER COMPRESSORS

Alternative Part No



9115530020	9115531030
9115531000	9115531040
9115531010	9115531050

EKWA.9.H



EKWA.9.H.CH



EKWA.95.CR



EKWA.90.RP.STD



Alternative Part No



9125100010

EKKB.9.2G.BU



EKWA.96.CR



EKWA.95.R.STD



EKWA.95.RP.STD



EKWA.123



EKWA.123.CH



Alternative Part No



9125101000	9125101030
9125101010	9125101040
9125101020	

EKWA.9.5



SEKWA.9.5

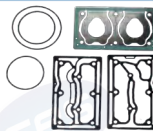

EKWA.9.5.CH



EKWA.95.CR



C1001



EKWA.95.R.STD



EKWA.95.RP.STD



Alternative Part No



9125102000









EKWA.9.3.CH



EKWA.9.3.CHO



WABCO TWIN CYLINDER COMPRESSORS

<p>Alternative Part No</p> 	<p>EKKB.9.2G.BU</p> 	<p>EKWA.96.CR</p> 	<p>EKWA.9.4</p> 	<p>SEKWA.9.4</p> 
	<p>EKWA.9.4.CHP</p> 	<p>EKWA.95.RP.STD</p> 	<p>C1003</p> 	
<p>9125120010 9125120060 9125140010</p>	<p>9125140030 9125140040</p>			

<p>Alternative Part No</p> 	<p>EKWA.9.14</p> 	<p>EKWA.9.14.AU</p> 
	<p>EKWA.9.14.C</p> 	<p>EKWA.9.14.CH</p> 
<p>9125120330</p>		

<p>Alternative Part No</p> 	<p>EKWA.9.8</p> 	<p>EKWA.9.8.CH</p> 	<p>C1002</p> 
	<p>EKWA.95.RP.STD</p> 	<p>EKWA.95.R.STD</p> 	<p>CRANK-GEAR14</p> 
<p>9125180000 9125180010 9125180020</p>	<p>9125180030 9125180040</p>		

ALL PISTON RINGS ARE AVAILABLE IN OVERSIZE ORDER SETS USING THIS RULE : (e.g. EK--.--.RP.STD = Standard size item.)
 e.g. EK--.--.RP.010= .010 oversize item./e.g. EK--.--.RP.020= .020 oversize item./e.g. EK--.--.RP.030= .030 oversize item./e.g. EK--.--.RP.040= .040 oversize item.

COMPRESSIONS

WABCO TWIN CYLINDER COMPRESSORS

Alternative Part No



9125180050
9125189252

EKWA.9.12.CH

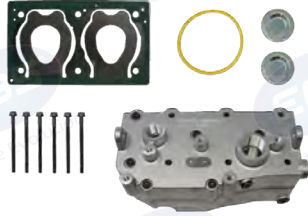

Alternative Part No



9125181000
9125181010
9125181020
9125181030
9125181040
9125182000
9125182010

9125182020
9125182030
9125182040
9125182050
9125182060
9125182070

EKWA.9.9.CH



EKWA.9.9.CP

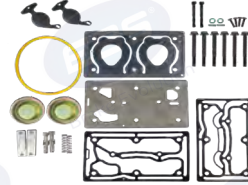

EKWA.95.R.STD



EKWA.95.RP.STD



C1001



Alternative Part No



9125220000
9125220010
9125220020

EKWA.10006

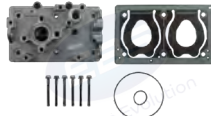

EKWA.10007

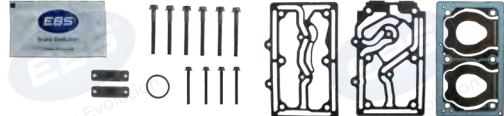

TO SUIT CYLINDER HEAD
9125229242

MAGNETI MARELLI SINGLE CYLINDER COMPRESSORS

<p>Alternative Part No</p>  <p>ACX67A ACX67AA ACX67AAG ACX67AX</p> <p>ACX67AZ ACX67AZG ACX67BA ACX67BAG</p>	<p>EKMM.14</p> 	<p>EKMM.14.1</p>  <p>EKMM.90.R.STD</p> 	<p>EKMM.90.CR</p>  <p>EKMM.90.RP.STD</p> 
<p>Alternative Part No</p>  <p>ACX68D</p>	<p>EKMM.16</p> 		
<p>Alternative Part No</p>  <p>ACX75ZB ACX75ZF ACX75ZG</p> <p>ACX75ZFG ACX75ZM ACX75ZMG</p>	<p>EKMM.12</p> 	<p>EKMM.12.1</p>  <p>EKMM.12.RP.STD</p> 	<p>EKMM.12.CHO</p>  <p>EKMM.90.CR</p> 
<p>Alternative Part No</p>  <p>ACX83A ACX83B</p> <p>ACX83AS ACX83D</p>	<p>EKMM.90</p> 	<p>EKMM.90.CH</p>  <p>EKMM.91.RP.STD</p>  <p>EKMM.92.RP.STD</p> 	

ALL PISTON RINGS ARE AVAILABLE IN OVERSIZE ORDER RING SETS USING THIS RULE : (e.g. EK--.--RP.STD = Standard size item.)
 e.g. EK--.--RP.010= .010 oversize item./e.g. EK--.--RP.020= .020 oversize item./e.g. EK--.--RP.030= .030 oversize item./e.g. EK--.--RP.040= .040 oversize item.

COMPRESSORS

BENDIX TUFLO COMPRESSORS

Alternative Part No

TUFLO 400: 280722 280728

EKBE.1

EKBE.3



Alternative Part No

TUFLO 500: 280737 271721
TUFLO 700: 289257

EKBE.11.RP.STD

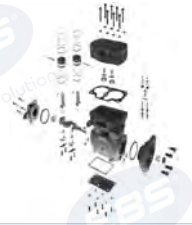

EKBE.15

EKBE.12

EKBE.13

Alternative Part No

TUFLO 501: 286104 285977
286546 287034

EKBE.15.3

EKBE.19.RP.STD

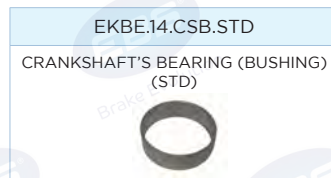
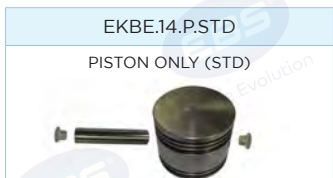
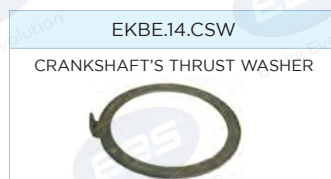
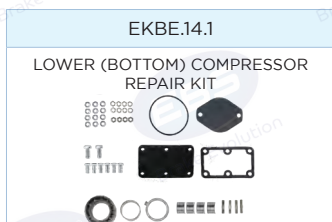
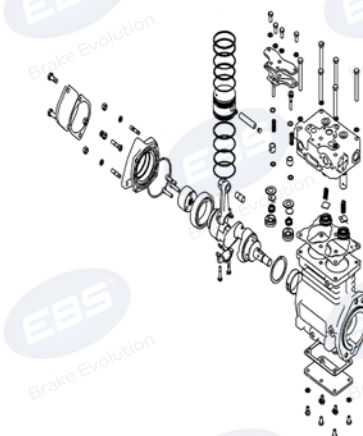
BENDIX TUFLO 750 COMPRESSORS



COMPRESSORS

ALL PISTON RINGS ARE AVAILABLE IN OVERSIZE ORDER RING SETS USING THIS RULE : (e.g. EK--.--.RP.STD = Standard size item.)
e.g. EK--.--.RP.010= .010 oversize item./e.g. EK--.--.RP.020= .020 oversize item./e.g. EK--.--.RP.030= .030 oversize item./e.g. EK--.--.RP.040= .040 oversize item.

CLAYTON DEWANDRE COMPRESSORS

Alternative Part No	Alternative Part No	Alternative Part No
PCGA1046	PCGA1059	PCGA1072

EKCD.3.4 	EKCD.3.1.CH 	EKCD.3.L 	EKCD.3.CP
--------------	-----------------	--------------	---------------

RENAULT MAJOR / MAGNUM COMPRESSORS

EKPP.9.1.C 	EKPP.9.1 	EKPP.9.1.CB 	EKPP.9.1.CH 	EKPP.9.RP
EKPP.9.C 	EKPP.9 	EKPP.9.CH 	EKPP.9.CR 	EKPP.9.CS
	EKPP.9.CB 			

VARGA COMPRESSORS

Alternative Part No 	EKVA.1 	EKVA.6 	EKVA.11
EL1600			

MAN COMPRESSORS

Alt. Part No 	Alt. Part No 	Alt. Part No 	Alt. Part No 	Alt. Part No 		Alt. Part No 
51540007057	51540007059	51540007063	51540007073	51540007027 51540007079 51540007086 51540007121	51540007131 51540007135 51541006001	51540007082 51540007109

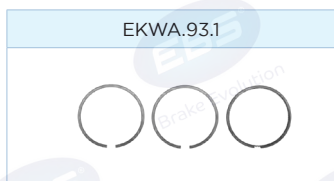
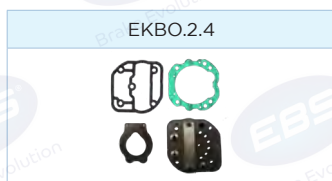
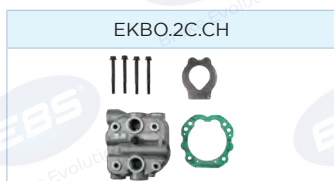

ALL PISTON RINGS ARE AVAILABLE IN OVERSIZE ORDER RING SETS USING THIS RULE : (e.g. EK--.--.RP.STD = Standard size item.)
e.g. EK--.--.RP.010= .010 oversize item./e.g. EK--.--.RP.020= .020 oversize item./e.g. EK--.--.RP.030= .030 oversize item./e.g. EK--.--.RP.040= .040 oversize item.

COMPRESSORS

MAN COMPRESSORS

	Alternative Part No	Alternative Part No	Alternative Part No
TYPE 1			
	51540007058	51540007058	51540007058
	Application	Application	Application
	MAN 19.260/ 19.360/ 19.361/ 1919/ 1922 MERCEDES OM402/ 403/ 407 MERCEDES 4471301815 4751300115	MAN 1919 / 1922 MERCEDES MB407 MERCEDES 4071300115	MAN MERCEDES

EKBO.2.A

To Suit: **Type 3**

EKBO.2.C

To Suit: **Type 1**

EKBO.2C.DIM

To Suit: **Type 2**

EKBO.2.4

To Suit: **Type 1**

EKBO.147

To Suit: **Type 3**

EKKB.100.1

To Suit: **Type 2**

EKBO.2C.CH

To Suit: **Type 1**

EKBO.2.A.CH

To Suit: **Type 3**

EKKB.427.5.CH

To Suit: **Type 2**

EKWA.93.1

EKWA.97.A

EKWA.97.CR



EKWA.97.CS

EKWA.97.RP.STD

EKBO.2.BR

EKBO.2.BU

MAN COMPRESSORS

TYPE 1	Alternative Part No	TYPE 2	Alternative Part No	TYPE 3	Alternative Part No	TYPE 4	Alternative Part No
							
	51540007074		51540007074		51540007074		51540007074
	Application		Application		Application		Application
MAN - MERCEDES		MAN - MERCEDES		MAN - MERCEDES		MAN - MERCEDES	

EKBO.2C To Suit: Type 3 	EKBO.2C.DIM To Suit: Type 2 	EKBO.2.4 To Suit: Type 1 Type 3 	EKBO.2.19 To Suit: Type 2 
EKBO.2.16 To Suit: Type 4 	EKBO.2C.CH To Suit: Type 1 Type 3 	EKBO.2.16.CH To Suit: Type 4 	EKBO.2.19.CH To Suit: Type 2 
EKBO.146 To Suit: Type 4 	EKBO.148 To Suit: Type 2 	EKBO.149 To Suit: Type 2 	EKWA.93.1 
EKWA.97.W 	EKWA.97.CR 	EKWA.97.CS 	EKWA.97.RP.STD 
EKBO.2.BR 	EKBO.2.BU 		

COMPRESSORS

ALL PISTON RINGS ARE AVAILABLE IN OVERSIZE ORDER RING SETS USING THIS RULE : (e.g. EK--.--.RP.STD = Standard size item.)
e.g. EK--.--.RP.010= .010 oversize item./e.g. EK--.--.RP.020= .020 oversize item./e.g. EK--.--.RP.030= .030 oversize item./e.g. EK--.--.RP.040= .040 oversize item.

MAN COMPRESSORS

Alternative Part No	Alternative Part No
	
51540007178	51541006003 51541007010 51541006007 51541007028 51541006009 51541007066

EKBO.2.A



To Suit: 51540007178

EKWA.102



To Suit: 51541006003-7066

EKBO.147



To Suit: 51540007178

EKWA.102.CH



To Suit: 51541006003-7066

EKBO.2.A.CH



To Suit: 51540007178

EKWA.93.1



EKWA.97.RP.STD



EKWA.97.CS



To Suit: 51540007178

EKWA.97.CR



EKBO.2.BR



To Suit: 51541006003-7066

EKBO.2.BU



To Suit: 51541006003-7066

Alternative Part No



51541007033

EKWA.97.CS



EKWA.97.CR



EKWA.118



EKWA.118.CH



EKWA.118.RP.STD



EKWA.118.CB



MAN COMPRESSORS

Alternative Part No	Alternative Part No	Alternative Part No	
			
51541006005 51541007003	51541007249	51541006011 51541006013 51541006015	51541007025 51541007179

EKBO.2.BU To Suit: 51541006005 51541007003 51541007249 	EKWA.97.CS To Suit: 51541006011 51541006013 51541006015 51541007025 51541007179 	EKWA.118 	EKWA.118.CB 
EKWA.118.CH 	EKWA.118.RP.STD 	EKWA.118.CR 	

MERCEDES COMPRESSORS

Alternative Part No  4471302215 4471303315 4471302015	EKBO.2.7 	EKBO.2.8 	EKBO.218  EKWA.118.RP.STD 
Alternative Part No  4571305015 9125103000 9125103030	EKWA.9.6 	EKWA.9.6.CH1  C1001 	EKWA.9.6.CH2  EKWA.95.RP.STD 

ALL PISTON RINGS ARE AVAILABLE IN OVERSIZE ORDER RING SETS USING THIS RULE : (e.g. EK--.--RP.STD = Standard size item.)
e.g. EK--.--RP.010= .010 oversize item./e.g. EK--.--RP.020= .020 oversize item./e.g. EK--.--RP.030= .030 oversize item./e.g. EK--.--RP.040= .040 oversize item.

COMPRESSIONS

MERCEDES COMPRESSORS

Alternative Part No



4721300015
4721300815
4721301515

EKBO.2.18



EKBO.2.18.CP



EKBO.2.18.CH



Alternative Part No



ACTROS OM501/502

ACTROS OM501/502 (V6N - V8N)

EKBO.2.12A



EKBO.2.12



EKBO.2.12CP



EKBO.2.9



EKBO.2.9CP



EKBO.129



EKWA.118.RP.STD



EKBO.130



EKBO.150



EKKB.428.9.CH



Alternative Part No



4471302815

EKBO.2.15



EKBO.2.15CP



EKBO.2.15.CS



EKWA.118.RP.STD



EKBO.131



MERCEDES COMPRESSORS

<p>Alternative Part No</p>  <p>5411303619</p>	<p>EKBO.2.17</p> 	<p>EKBO.2.17.CP</p> 	<p>EKBO.2.17.CR</p>  <p>EKBO.132</p> 
--	--	--	---

<p>Alternative Part No</p>  <p>3521300615 3521300215</p>	<p>EKWA.96.A</p>  <p>EKWA.96.CH</p> 
---	---

MERCEDES COMPRESSORS - OTHERS

<p>EKBO.2.9.W</p>   <p>To suit 5411300108</p>	<p>EKBO.2.17.W</p>   <p>To suit 5411300108</p>
--	---

ALL PISTON RINGS ARE AVAILABLE IN OVERSIZE ORDER RING SETS USING THIS RULE : (e.g. EK--.--RP.STD = Standard size item.)
 e.g. EK--.--RP.010= .010 oversize item./e.g. EK--.--RP.020= .020 oversize item./e.g. EK--.--RP.030= .030 oversize item./e.g. EK--.--RP.040= .040 oversize item.

COMPRESSORS

VOITH COMPRESSORS

Alternative Part No

14900006015 / 14900077203 14900085312 / 14900095502 14900107503 / 14900109402 14900113202 / 14900128010 14900140911 / 14900148802 14900172710

EKVO.1

EKVO.60.RP.STD

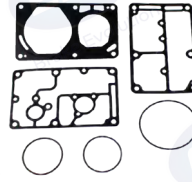
EKVO.2

EKVO.92.C

EKVO.60.C

EKVO.92.RP.STD

Alternative Part No

14900127710 14900127711

EKVO.7

EKVO.7.92.C
CYLINDER LINER 92mm

Alternative 14900127711

EKVO.7.2

Alternative 14900127711

EKVO.7.CH

Alternative 14900127710

EKVO.7.60.C
CYLINDER LINER 60mm

Alternative 14900127711

EKVO.60.RP.STD



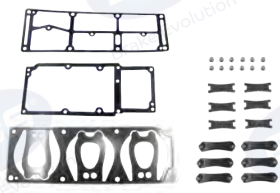

EKVO.92.RP.STD

Alternative Part No

LP700

EKVO.10000
REPAIR KIT (VALVES & GASKETS)

MISC. FITTING ACCESSORIES

<p>CRANK-GEAR1</p>  <p>2022257</p>	<p>CRANK-GEAR2</p>  <p>2022259</p>	<p>CRANK-GEAR3</p>  <p>4071300030</p>	<p>CRANK-GEAR4</p>  <p>4295536</p>
<p>CRANK-GEAR5</p>  <p>4111510040</p>	<p>CRANK-GEAR6</p>  <p>LP4825, 9115051510</p>	<p>CRANK-GEAR7</p>  <p>LP4845</p>	<p>CRANK-GEAR8</p>  <p>LP4851, 4124420000</p>
<p>CRANK-GEAR9</p>  <p>51542100108</p>	<p>CRANK-GEAR10</p>  <p>LK4941</p>	<p>CRANK-GEAR11</p>  <p>4571320905</p>	<p>CRANK-GEAR12</p>  <p>9061320305</p>
<p>CRANK-GEAR13</p>  <p>1205112</p>	<p>CRANK-GEAR14</p>  <p>1641625</p>	<p>CRANK-NUT 1</p>  <p>RIGHT HAND M18 x 1.5</p>	<p>CRANK-NUT 2</p>  <p>RIGHT HAND M20 x 1.5</p>
<p>CRANK-NUT 3</p>  <p>LEFT HAND M20 x 1.5</p>	<p>CRANK-NUT 4</p>  <p>LEFT HAND M18 x 1.5</p>	<p>FLANGEGASKET-1</p>  <p>LK3850</p>	<p>FLANGEGASKET-2</p>  <p>9111450600 9111455600</p>
<p>FLANGESEAL-1</p>  <p>LK3833 LK3875</p> <p>LP4845 LP4944</p>	<p>FLANGESEAL-2</p>  <p>LK4918 LK4941 LP4814 LP4815</p> <p>LP4825 LP4964 9115051500</p>	<p>FLANGESEAL-3</p>  <p>LK4921</p>	<p>FLANGESEAL-4</p>  <p>LP4857 LP4851 LP4974 LP4992</p> <p>4127040080 9115040520 9125182060</p>

COMPRESSORS

ALL PISTON RINGS ARE AVAILABLE IN OVERSIZE ORDER RING SETS USING THIS RULE : (e.g. EK--.--.RP.STD = Standard size item.)
e.g. EK--.--.RP.010= .010 oversize item./e.g. EK--.--.RP.020= .020 oversize item./e.g. EK--.--.RP.030= .030 oversize item./e.g. EK--.--.RP.040= .040 oversize item.

MISC. FITTING ACCESSORIES

<p>FLANGESEAL-5</p> <p>4111510040 9121170000</p>	<p>FLANGESEAL-6</p> <p>4111510090 4115530030</p>	<p>FLANGESEAL-7</p> <p>4123520030 9121160000</p>	<p>FLANGESEAL-8</p> <p>9115045060</p>
<p>FLANGESEAL-9</p> <p>9125140090</p>	<p>FLANGESEAL-10</p> <p>4123520030 9121160000</p>	<p>FLANGESEAL-11</p> <p>LK3966</p>	<p>FLANGESEAL-12</p> <p>LK3869</p>
<p>FLANGESEAL-13</p> <p>LK4949</p>	<p>FLANGESEAL-14</p> <p>9125180040 9125180050 9125181030</p>	<p>FLANGESEAL-15</p> <p>4123520250 4127040140</p>	<p>FLANGESEAL-16</p> <p>4127040190</p>

HYDROVANE COMPRESSOR



T02	
Hydrovane Compact Vane Compressor	
FITS WRIGHTBUS	
Repair Kit	---

Benefits

Lightweight and compact design - saving fuel and maximising passenger space.













Extremely quiet and vibration free operation - providing a noise-free passenger environment.

Fully integrated module - saving up to 50% of the weight of conventional designs.

Water-cooled design requires no ventilation- enabling easy installation where space is at a premium.

Variable speed inverter drive technology - Integrating with customer system.

EBS NEW & REMANUFACTURED COMPRESSORS - KNORR BREMSE

06.02.1314		06.02.1506		06.02.1527		06.02.1802	
							
Alternative Part No	LK1314	Alternative Part No	LK1506	Alternative Part No	LK1527	Alternative Part No	LK1802 180864
06.02.1973		R06.02.1567		06.02.1813		R06.02.1813	
							
Alternative Part No	LK4973 K168097N00	Alternative Part No	LK1567	Alternative Part No	LK1813	Alternative Part No	LK1814
R06.02.1833		R06.02.1840		06.02.1841		R06.02.1841	
							
Alternative Part No	LK3833	Alternative Part No	LK3840	Alternative Part No	LK3841	Alternative Part No	LK3850
R06.02.1859		R06.02.1869		06.02.1875		R06.02.1875	
							
Alternative Part No	LK3859	Alternative Part No	LK3869	Alternative Part No	K008457X00 LK3875	Alternative Part No	LK3966
06.02.1901		R06.02.1918		R06.02.1920		06.02.1920	
							
Alternative Part No	LK1901	Alternative Part No	LK4918	Alternative Part No	LK4920 K00203200	Alternative Part No	LK4921

ALL PISTON RINGS ARE AVAILABLE IN OVERSIZE ORDER RING SETS USING THIS RULE : (e.g. EK--.--RP.STD = Standard size item.)
e.g. EK--.--RP.010= .010 oversize item./e.g. EK--.--RP.020= .020 oversize item./e.g. EK--.--RP.030= .030 oversize item./e.g. EK--.--RP.040= .040 oversize item.

COMPRESSORS

EBS NEW & REMANUFACTURED COMPRESSORS - KNORR BREMSE

06.02.1927		R06.02.1936		06.02.1937		06.02.1939	
Alternative Part No	LK3927	Alternative Part No	LK4936	Alternative Part No	LK4937	Alternative Part No	LK4939 K09587N00
06.02.1941		R06.02.1941		R06.02.1944		06.02.1947	
Alternative Part No	LK4941	Alternative Part No	LK4944	Alternative Part No	LK3947 K040432N00	Alternative Part No	LK4951
06.02.1960		06.02.1970		06.02.1980		R06.02.2701	
Alternative Part No	LK4960 K089063N00	Alternative Part No	LK4970 K038653N00	Alternative Part No	LK3980	Alternative Part No	LP8701 K015518
06.02.2812		R06.02.2812		06.02.2813		06.02.2814	
Alternative Part No	LP4812	Alternative Part No	LP4813	Alternative Part No	LP4814	Alternative Part No	LP4815
06.02.2815		06.02.2815		06.02.2823		R06.02.2823	
Alternative Part No	LP4815	Alternative Part No	LP4815	Alternative Part No	LP4823	Alternative Part No	LP4823
R06.02.2825		06.02.2825		06.02.2828		06.02.2844	
Alternative Part No	LP4825	Alternative Part No	LP4825	Alternative Part No	LP1828	Alternative Part No	LP4844

EBS NEW & REMANUFACTURED COMPRESSORS - KNORR BREMSE

06.02.2845	R06.02.2845	06.02.2850		R06.02.2851	06.02.2851	06.02.2855	
							
Alternative Part No	LP4845	Alternative Part No	LP4850	Alternative Part No	LP4851	Alternative Part No	LP4855
06.02.2857		R06.02.2861		R06.02.2863		R06.02.2864	
							
Alternative Part No	LP4857	Alternative Part No	LP4861	Alternative Part No	LP4863	Alternative Part No	LP4864
06.02.2865		R06.02.2871	06.02.2871	06.02.2927		06.02.2934	R06.02.2934
							
Alternative Part No	LP4865	Alternative Part No	LP4871 K035001N00	Alternative Part No	LP3927 176067	Alternative Part No	LP4934
06.02.2940		06.02.2955		06.02.2957	R06.02.2957	06.02.2960	
							
Alternative Part No	LP3940 1114385	Alternative Part No	LP4955	Alternative Part No	LP4957	Alternative Part No	LP4960
06.02.2961	R06.02.2961	06.02.2964	R06.02.2964	06.02.2967	R06.02.2967	R06.02.2970	
							
Alternative Part No	LP4961	Alternative Part No	LP4964	Alternative Part No	LP4967	Alternative Part No	LP3970



ALL PISTON RINGS ARE AVAILABLE IN OVERSIZE ORDER RING SETS USING THIS RULE : (e.g. EK--.--RP.STD = Standard size item.)
 e.g. EK--.--RP.010= .010 oversize item./e.g. EK--.--RP.020= .020 oversize item./e.g. EK--.--RP.030= .030 oversize item./e.g. EK--.--RP.040= .040 oversize item.

COMPRESSORS

EBS NEW & REMANUFACTURED COMPRESSORS - KNORR BREMSE

06.02.2974	R06.02.2974	06.02.2983	06.02.2983	06.02.2985	R06.02.2985	06.02.2992	
Alternative Part No	LP4974	Alternative Part No	LP4983	Alternative Part No	LP4985	Alternative Part No	LP4992
06.02.2997	R06.02.2997	06.02.3813		06.02.3907		06.02.10000	
Alternative Part No	LP3997	Alternative Part No	LK3813 I94314	Alternative Part No	K157264N00 LS3907	Alternative Part No	LK4975 K171591N00
06.02.10001		06.06.1000		06.06.1001		06.06.1002	
Alternative Part No	LK8907 K162503N00	Alternative Part No	KZ1228/1X50	Alternative Part No	KZ396/3X50	Alternative Part No	KZ433/1X50 1186722SP
06.06.1003	R06.06.1003	06.06.1004	R06.06.1004	R06.06.1005		R06.06.1007	
Alternative Part No	BR5503	Alternative Part No	KZ996/2X50	Alternative Part No	1194215X50	Alternative Part No	KZ1087/4X50
R06.06.1008		R06.06.1009		R06.06.1010		R06.06.1011	
Alternative Part No	KZ1257/3X50	Alternative Part No	101256	Alternative Part No	289924	Alternative Part No	1189497

EBS NEW & REMANUFACTURED COMPRESSORS - KNORR BREMSE

R06.06.1012		R06.06.1013		R06.06.1006	06.06.1014	06.07.1002	
							
Alternative Part No	1189289	Alternative Part No	287631	Alternative Part No	KZ1143/2X50	Alternative Part No	KO07388/ ACX69D

EBS NEW COMPRESSORS - MAN

06.26.1003		06.26.1004		06.26.1006		06.26.1001 Air Cooled Barrel	
							
Alternative Part No	51541006007	Alternative Part No	51541006015	Alternative Part No	51541007033	Alternative Part No	51540007058
06.26.1007		06.26.1002 Water Cooled Barrel		06.26.1005			
							
Alternative Part No	51540007064	Alternative Part No	51540007074	Alternative Part No	51541007178		

EBS NEW COMPRESSORS - MARELLI

06.07.1000	
	
Alternative Part No	ACX83D

06.07.1001	
	
Alternative Part No	---

EBS NEW COMPRESSORS - VOITH

06.44.7710	
	
Alternative Part No	14900127710

ALL PISTON RINGS ARE AVAILABLE IN OVERSIZE ORDER RING SETS USING THIS RULE : (e.g. EK--.--.RP.STD = Standard size item.)
 e.g. EK--.--.RP.010= .010 oversize item./e.g. EK--.--.RP.020= .020 oversize item./e.g. EK--.--.RP.030= .030 oversize item./e.g. EK--.--.RP.040= .040 oversize item.

COMPRESSORS

EBS NEW & REMANUFACTURED COMPRESSORS - WABCO

R06.01.1000	06.01.1000	R06.01.1001	06.01.1002	06.01.1004	R06.01.1004
Alternative Part No	4111510000	Alternative Part No	4111410100	Alternative Part No	4111540040 4111540000 4111540030

06.01.1009	R06.01.1009	06.01.1501	06.01.1805	R06.01.2003	06.01.2003
Alternative Part No	4111510090	Alternative Part No	4110345010	Alternative Part No	4123520030

06.01.2008	R06.01.2008	06.01.2018	R06.01.2018	06.01.2019	R06.01.2025	06.01.2025	
Alternative Part No	4127040080	Alternative Part No	4127040180 4127040277	Alternative Part No	4127040190	Alternative Part No	4123520250

06.01.2027	06.01.2030	06.01.3052	06.01.3060
Alternative Part No	4123520307	Alternative Part No	4123520300
Alternative Part No	9115040520	Alternative Part No	9115040600

R06.01.3104	06.01.3104	06.01.3150	06.01.3506	R06.01.3506	06.01.4000
Alternative Part No	9115531040	Alternative Part No	9115051500 9115051510	Alternative Part No	9115045060
Alternative Part No		Alternative Part No		Alternative Part No	9121170000

EBS NEW & REMANUFACTURED COMPRESSORS - WABCO

06.01.4001		06.01.10000		06.01.10001	
					
Alternative Part No	9125101040	Alternative Part No	9125180050	Alternative Part No	9122100000

EBS NEW COMPRESSORS - MAN

R06.01.4002	06.01.4002	R06.01.4003		06.01.4004		R06.01.4005	
							
Alternative Part No	9125180040	Alternative Part No	912180030	Alternative Part No	9125120080 9125120290 9125140040	Alternative Part No	9125100010

06.01.4006		06.01.4012		R06.01.4015		06.01.4029	
							
Alternative Part No	9121160000	Alternative Part No	9125102000	Alternative Part No	9125120150	Alternative Part No	9125120290

06.01.4104	
	
Alternative Part No	9125101040

COMPRESSORS

ALL PISTON RINGS ARE AVAILABLE IN OVERSIZE ORDER RING SETS USING THIS RULE : (e.g. EK--.--.RP.STD = Standard size item.)
 e.g. EK--.--.RP.010= .010 oversize item./e.g. EK--.--.RP.020= .020 oversize item./e.g. EK--.--.RP.030= .030 oversize item./e.g. EK--.--.RP.040= .040 oversize item.

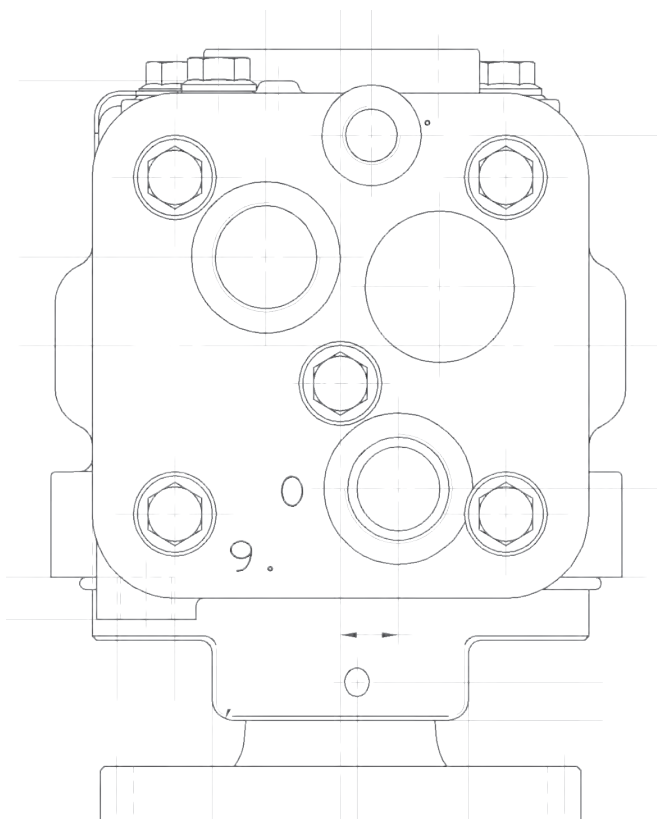
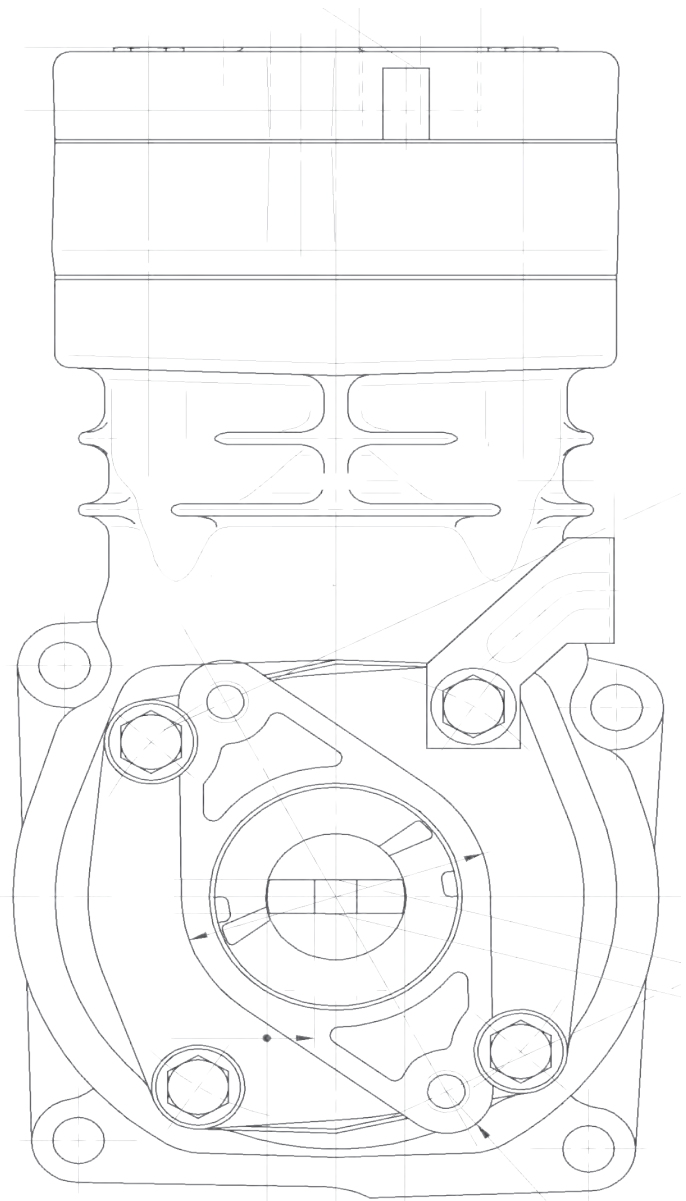

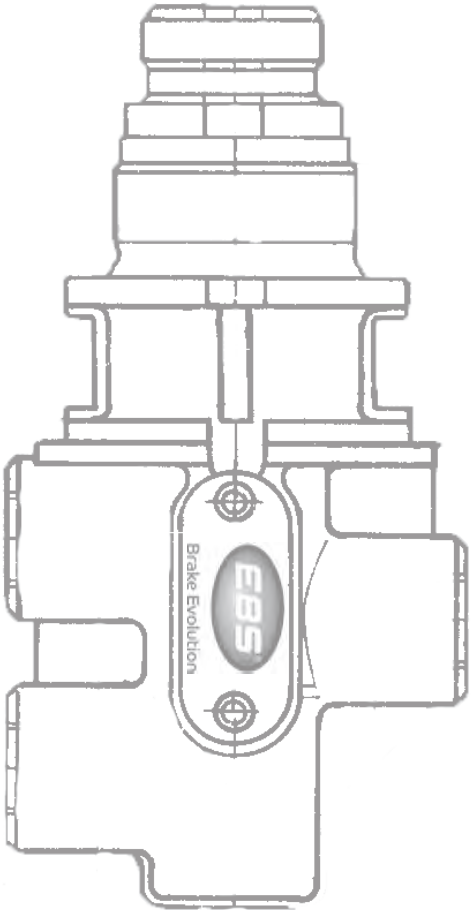
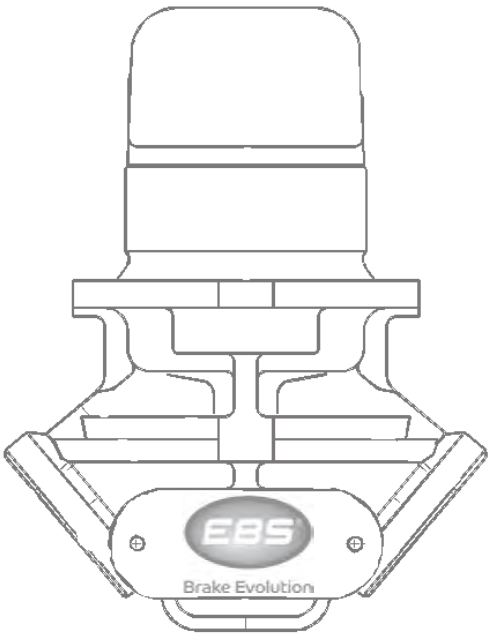
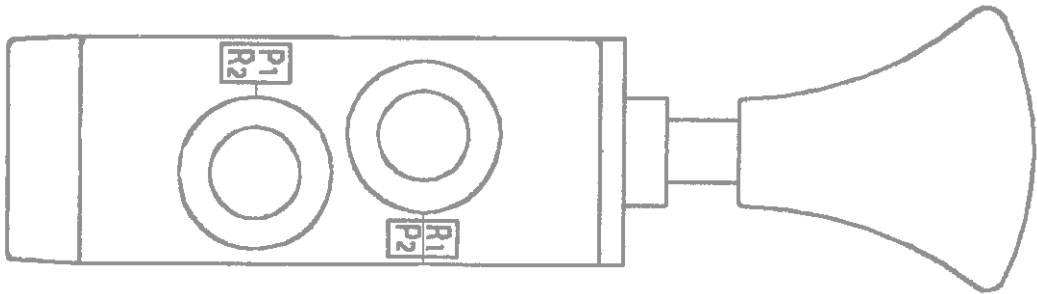

DISTRIBUTOR VALVES



EBS DISTRIBUTOR VALVES

---	---	---	---	---
ALT. Part No. 03029902 (Norgren)	ALT. Part No. 03040102 (Norgren)	ALT. Part No. 03040502 (Norgren)	ALT. Part No. 03040602 (Norgren)	ALT. Part No. 03040802 (Norgren)
Repair Kit ---	Repair Kit ---	Repair Kit ---	Repair Kit ---	Repair Kit ---
---	---	---	07.32.1000	---
ALT. Part No. 03041102 (Norgren)	ALT. Part No. 03041302 (Norgren)	ALT. Part No. 030601M2 (Norgren) 1194130 (Knorr)	ALT. Part No. 03060102 (Norgren) 1194131 (Knorr) (Metric)	ALT. Part No. 03061102 (Norgren) 563441100 (Rexroth)
Repair Kit ---	Repair Kit ---	Repair Kit ---	Repair Kit ---	Repair Kit ---
07.04.1000	---	---	---	07.31.1000
ALT. Part No. 0481007031000 (Knorr)	ALT. Part No. 0481007049 (Knorr)	ALT. Part No. 0481007501 (Knorr)	ALT. Part No. 054997 Schmitz Application c/w fittings	ALT. Part No. 500789615 5000789615 (Lucifer)
Repair Kit ---	Repair Kit ---	Repair Kit ---	Repair Kit ---	Repair Kit ---
---	---	---	---	---
ALT. Part No. 5717400000 (Rexroth)	ALT. Part No. AR20-F02 (SMC)	ALT. Part No. CL-9200A (Univer)	ALT. Part No. CM9420 (Univer)	ALT. Part No. D1410000 (Bertocco)
Repair Kit ---	Repair Kit ---	Repair Kit ---	Repair Kit ---	Repair Kit ---
---	---	07.06.3000	---	---
ALT. Part No. D1410240 (Bertocco)	ALT. Part No. D1410300 (Bertocco)	ALT. Part No. 277516	ALT. Part No. LS6000 (Knorr)	ALT. Part No. SPGB28814 (Norgren)
Repair Kit ---	Repair Kit ---	Repair Kit ---	Repair Kit ---	Repair Kit ---

EBS DISTRIBUTOR VALVES

---		---		---	
					
ALT. Part No.	X3064102 (Norgren)	ALT. Part No.	X3066502 (Norgren)	ALT. Part No.	X3067702 (Norgren)
Repair Kit	---	Repair Kit	---	Repair Kit	---

EBS KNORR 3/2 VALVES

---		---	
			
ALT. Part No.	WKV2130092 (Metric)	ALT. Part No.	WKV2130093 (Imperial)
Repair Kit	---	Repair Kit	---

EBS KNORR 5/2 VALVES - ELECTRIC

07.02.1000		07.02.1001		07.02.1002	
					
ALT. Part No.	K015384 (AE1141)	ALT. Part No.	K017224 (AE1141)	ALT. Part No.	K035570 (AE1141)
Repair Kit	---	Repair Kit	---	Repair Kit	---

EBS POWNALL PARK VALVE M16

	
ALT. Part No.	10223312
Repair Kit	---

EBS SMC 3/2 VALVES

---		---		---		---	
							
Alternative Part No	EVT307-5DZ-01F-Q	Alternative Part No	EVT307-6DZ-01F-Q	Alternative Part No	EVT317-5D-02F-Q	Alternative Part No	EVT317-5DZ-02F-Q
Repair Kit	---	Repair Kit	---	Repair Kit	---	Repair Kit	---

DISTRIBUTOR VALVES

EBS VOSS MANIFOLD VALVES

07.33.1000		---	
Alternative Part No	0233264200	Alternative Part No	0233304200
Repair Kit	---	Repair Kit	---

EBS MANIFOLD VALVE - 5 PORT PLASTIC

Alternative Part No	7992P
Repair Kit	---

EBS COOLANT CONTROL VALVES

01.26.1000		07.27.1000		07.28.1000	
Alternative Part No	MAN 81619670011	Alternative Part No	MERCEDES 0018302184	Alternative Part No	RENAULT 5001844056
Repair Kit	---	Repair Kit	---	Repair Kit	---

SCANIA - WATER CONTROL SOLENOID VALVES

07.29.2000		07.29.2001	
Alternative Part No	1741027	Alternative Part No	4460910300 / 2160199

EBS WABCO 3/2 DIRECTIONAL CONTROL VALVES

07.01.1000		07.01.1001		07.01.1005		07.01.1016		---	
ALT. Part No.	4630360000 173682	ALT. Part No.	4630360010	ALT. Part No.	4630360050	ALT. Part No.	4630360160	ALT. Part No.	5631129130
Repair Kit	---	Repair Kit	---	Repair Kit	---	Repair Kit	---	Repair Kit	EKWA.60.1

EBS WABCO 3/2 DIRECTIONAL CONTROL VALVES

EBS 4/2 DIRECTIONAL CONTROL VALVE

07.01.6026		07.01.1024		07.01.5000	
ALT. Part No.	4342050260	ALT. Part No.	4630360240	ALT. Part No.	554005001 5710040000 5710400000
Repair Kit	---	Repair Kit	---	Repair Kit	EKWA.60.1

07.01.2006	
ALT. Part No.	4630370060
Repair Kit	---

---		07.01.3000		---	
ALT. Part No.	5634461000	ALT. Part No.	5710020000	ALT. Part No.	8998504944 (Knob For 5634461000)
Repair Kit	8998504944	Repair Kit	EKWA.60.1	Repair Kit	---

EBS 4/3 DIRECTIONAL CONTROL VALVES

EBS WABCO 5/2 DIRECTIONAL CONTROL VALVES

07.01.2001		07.01.2004		07.01.4002	
ALT. Part No.	4630370010	ALT. Part No.	4630370040	ALT. Part No.	5710030020
Repair Kit	---	Repair Kit	---	Repair Kit	EKWA.60.1

07.01.4104		07.01.4920	
ALT. Part No.	5710031040	ALT. Part No.	5710039200
Repair Kit	EKWA.60.1	Repair Kit	---

EBS WABCO/ ZF 3/2 DIRECTIONAL CONTROL VALVES

REPAIR KITS

07.01.6031		07.01.6032		07.42.1000	
ALT. Part No.	4342050310	ALT. Part No.	4342050320	ALT. Part No.	0750132007
Repair Kit	---	Repair Kit	---	Repair Kit	---

EKWA.60.1	

DISTRIBUTOR VALVES

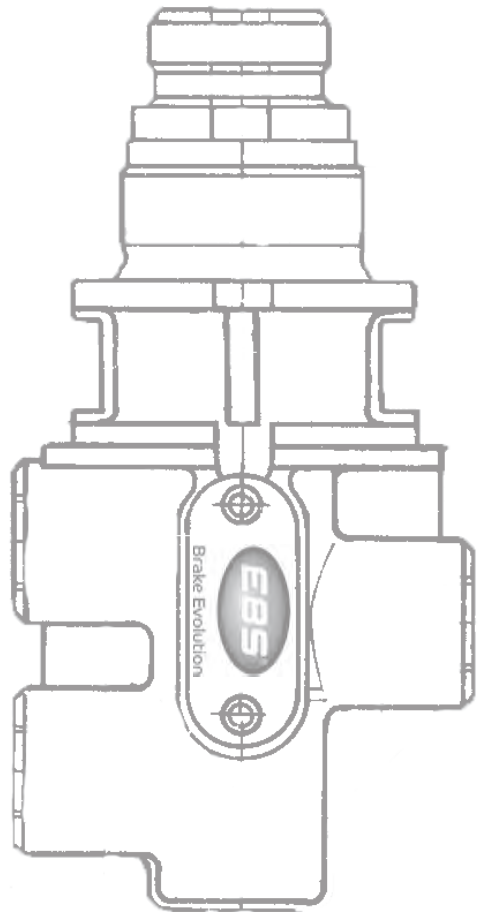
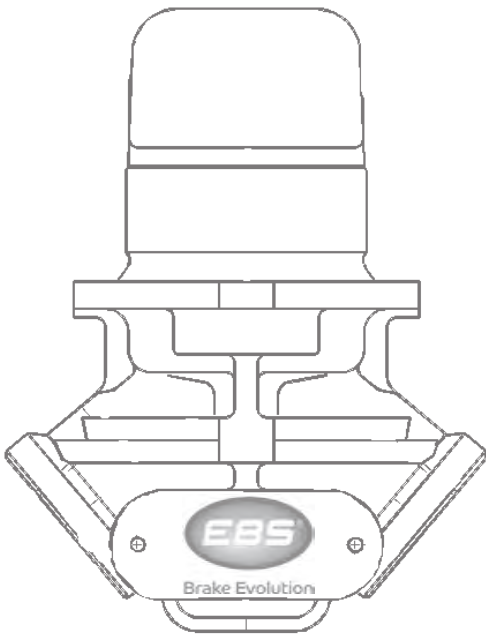
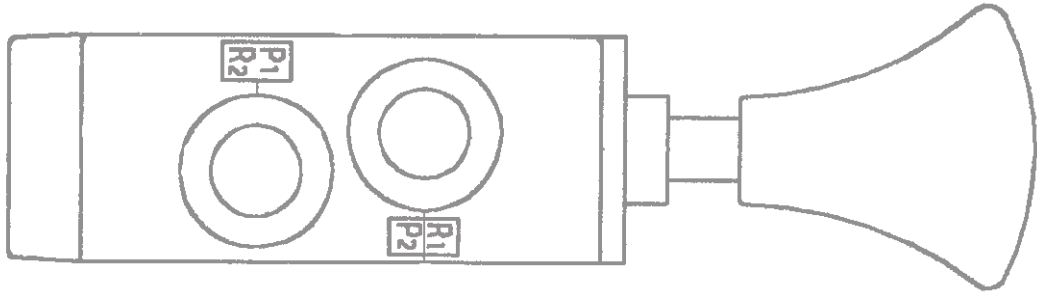

SOLENOID VALVES

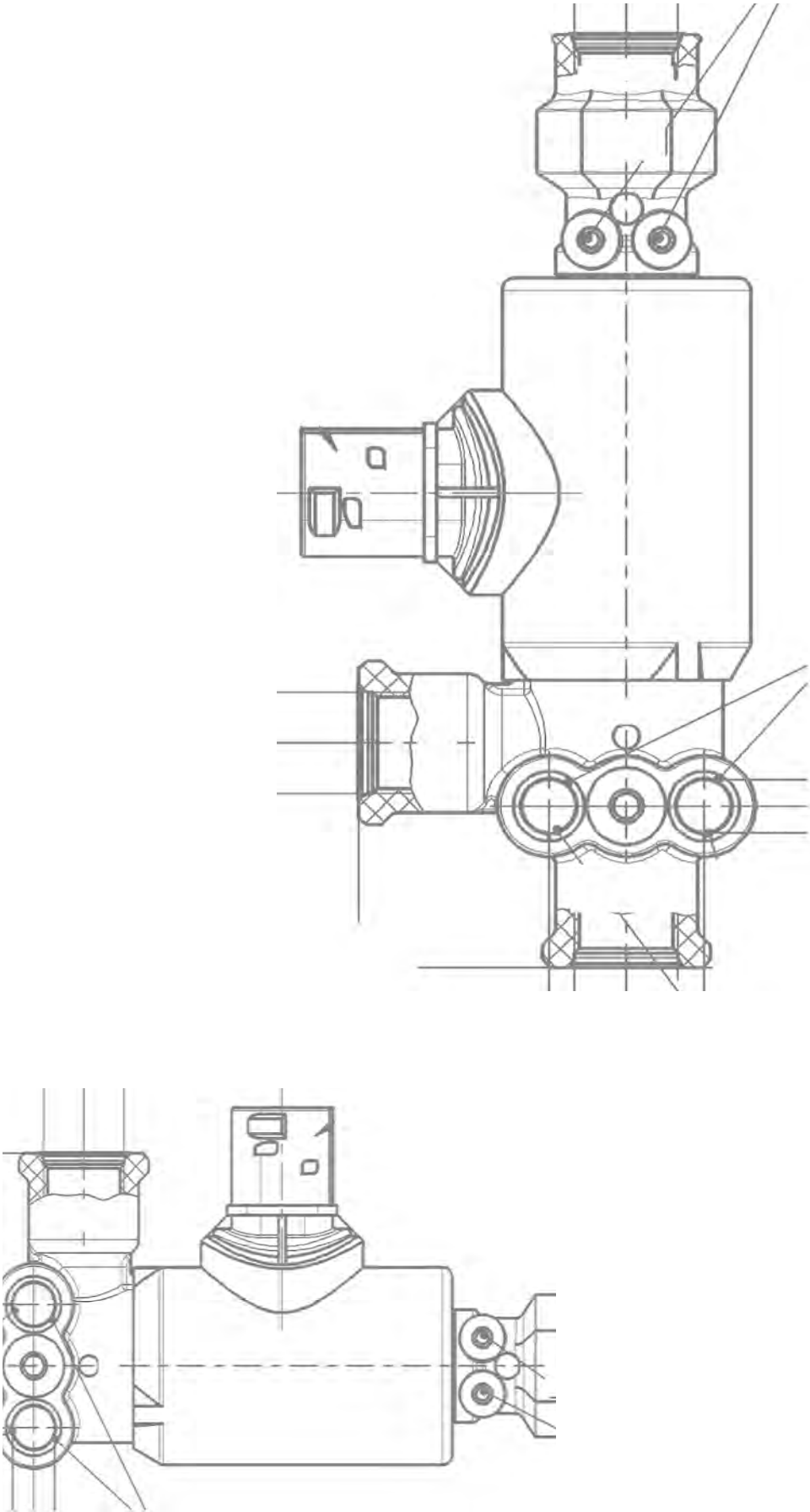

SOLENOID VALVES - HALDEX

Alternative Part No	580086C
Repair Kit	---

SOLENOID VALVES - HERION

08.10.1000		08.10.1001		08.10.1002		08.10.1003	
Alternative Part No	1442278	Alternative Part No	1078316	Alternative Part No	9033530	Alternative Part No	1078318 9042026
Repair Kit	EKPP.27	Repair Kit	---	Repair Kit	---	Repair Kit	---
08.29.1001		08.29.1003		08.29.1004		08.29.1005	
Alternative Part No	1340232 1421323	Alternative Part No	1421324	Alternative Part No	1421325 9012010	Alternative Part No	1421322
Repair Kit	EKPP.26.8	Repair Kit	EKPP.26.9	Repair Kit	EKPP.26.9	Repair Kit	---
08.30.1001		08.30.1002		08.30.1003		08.30.1004	
Alternative Part No	1610566	Alternative Part No	1610568	Alternative Part No	1610570	Alternative Part No	8158342
Repair Kit	EKPP.26.10	Repair Kit	EKPP.26.11	Repair Kit	EKPP.26.12	Repair Kit	EKPP.26.13

SOLENOID VALVES - KNORR BREMSE

08.04.1000		08.04.1002	08.04.1001
			
Alternative Part No	0481500007000	Alternative Part No	0481500101000 0481500102000
Repair Kit	EKBO.32	Repair Kit	EKBO.31

SOLENOID VALVES - MAN

08.29.1006		08.26.1001	08.26.1002
			
Alternative Part No	51259020123	Alternative Part No	51259020130 81.32688.6009
Repair Kit	---	Repair Kit	---

SOLENOID VALVES - MECMAN

08.29.1000		08.21.1000	08.21.1001	08.21.1003 This does not include the Solenoid	
					
Alternative Part No	1488083 1334037	Alternative Part No	1457275 1457276	Alternative Part No	X8880843
Repair Kit	EKPP.26.5A	Repair Kit	EKPP.26.6A	Repair Kit	---

08.21.1004 For 14mm Ports	
	
Alternative Part No	1395692
Repair Kit	---

SOLENOID VALVES

SOLENOID VALVES - MINDMAN

---		---	
			
Alternative Part No	MVA-220-3A1-NO	Alternative Part No	MVA-220-3A1-NC
Repair Kit	---	Repair Kit	---

SOLENOID VALVES - RENAULT VI

08.28.1000		08.28.1001		08.28.1002	
					
Alternative Part No	5010360034	Alternative Part No	5010360036	Alternative Part No	501058325
Repair Kit	---	Repair Kit	---	Repair Kit	---

SOLENOID VALVES - VOLVO

08.30.10001		08.30.10002		08.30.2001	
					
Alternative Part No	23439998	Alternative Part No	1068913	Alternative Part No	20913287
Repair Kit	---	Repair Kit	---	Repair Kit	---

SOLENOID VALVES - WABCO

	
Alternative Part No	3720600220
Repair Kit	EKWA.60.3

	
Alternative Part No	3720600620
Repair Kit	EKWA.60.3

08.01.B480	
	
Alternative Part No	4720174800 4720023020
Repair Kit	EKWA.31 or EKWA.31.1

	
Alternative Part No	4720174810
Repair Kit	EKWA.31.1

08.01.X628	
	
Alternative Part No	4720706280
Repair Kit	---

08.01.X639	
	
Alternative Part No	4720706390
Repair Kit	---

08.01.W628	
	
Alternative Part No	4720726280
Repair Kit	---

08.01.W639	
	
Alternative Part No	4720726390
Repair Kit	---

08.01.N152	
	
Alternative Part No	4720901520
Repair Kit	---

08.01.N202	
	
Alternative Part No	4720902020
Repair Kit	---

08.01.C108	
	
Alternative Part No	4721231080
Repair Kit	EKWA.31.2

08.01.H140	
	
Alternative Part No	4721271400
Repair Kit	EKWA.31.2

08.01.K000	
	
Alternative Part No	4721289080
Repair Kit	EKWA.31.2

08.01.L604	
	
Alternative Part No	4721331580
Repair Kit	EKWA.31.2

08.01.J001	
	
Alternative Part No	4721700010
Repair Kit	---

08.01.J600	
	
Alternative Part No	4721706000
Repair Kit	EKWA.31.2

08.01.J604	
	
Alternative Part No	4721706040
Repair Kit	EKWA.31.2

08.01.J606	
	
Alternative Part No	4721706060
Repair Kit	EKWA.31.2

08.01.J636	
	
Alternative Part No	4721706360
Repair Kit	EKWA.31.2

08.01.K000	
	
Alternative Part No	4721710000
Repair Kit	---

SOLENOID VALVES

SOLENOID VALVES - WABCO

08.01.K700	
Alternative Part No	4721717000
Repair Kit	---

08.01.K336	
Alternative Part No	4721713360
Repair Kit	---

08.01.K704	
Alternative Part No	4721717040
Repair Kit	---

08.01.K706	
Alternative Part No	4721717060
Repair Kit	---

08.01.K726	
Alternative Part No	4721717260
Repair Kit	---

08.01.L001	
Alternative Part No	4721720010
Repair Kit	---

08.01.L600	
Alternative Part No	4721726000
Repair Kit	EKWA.31.2

08.01.L604	
Alternative Part No	4721726040
Repair Kit	EKWA.31.2

08.01.L606	
Alternative Part No	4721726060
Repair Kit	EKWA.31.2

08.01.L620	
Alternative Part No	4721726200
Repair Kit	---

08.01.L626	
Alternative Part No	4721726260
Repair Kit	---

08.01.L686	
Alternative Part No	4721726860
Repair Kit	---

08.01.L726	
Alternative Part No	4721727260
Repair Kit	---

Alternative Part No	4721727840
Repair Kit	---

08.01.L786	
Alternative Part No	4721727860
Repair Kit	---

08.01.L901	
Alternative Part No	4721729010
Repair Kit	---

08.01.R206	
Alternative Part No	4721732060
Repair Kit	---

08.01.R226	
Alternative Part No	4721732260
Repair Kit	---

08.01.R428	
Alternative Part No	4721734280
Repair Kit	---

08.01.R700	
Alternative Part No	4721737000
Repair Kit	---

SOLENOID VALVES - WABCO

08.01.R701	
	
Alternative Part No	4721737010
Repair Kit	---

08.01.R704	
	
Alternative Part No	4721737040
Repair Kit	---

	
Alternative Part No	4721745970
Repair Kit	---

08.01.S316	
	
Alternative Part No	4721763160
Repair Kit	---

08.01.S916	
	
Alternative Part No	4721769060
Repair Kit	---

08.01.Y426	
	
Alternative Part No	4721784260
Repair Kit	---

08.01.T070	
	
Alternative Part No	4724000700
Repair Kit	EKWA.31.14 or EKWA.31.12

08.01.M000EX	
	
Alternative Part No	4722500000
Repair Kit	EKWA.31.7

08.01.M003	
	
Alternative Part No	4722500030
Repair Kit	EKWA.31.7

	
Alternative Part No	4722500070
EKWA.31.7	EKWA.31.7

08.01.P005	
	
Alternative Part No	4722600050
Repair Kit	EKWA.31.10A

08.01.P006	
	
Alternative Part No	4722600060
Repair Kit	EKWA.31.10A

08.01.P011	
	
Alternative Part No	4722600110
Repair Kit	EKWA.31.10A

SOLENOID VALVES

SHIFT SOLENOID VALVE - SCANIA

08.29.1009	
	
Alternative Part No	1493771
Repair Kit	---

EXHAUST BRAKE SOLENOID VALVE - VOLVO

08.30.1011	
	
Alternative Part No	21031448
Repair Kit	---

SOLENOID VALVES - OTHER

08.21.1002	
	
Alternative Part No	1734012
Repair Kit	---

08.27.1000	
	
Alternative Part No	A9452601957
Repair Kit	---

08.27.1001	
	
Alternative Part No	9702600457
Repair Kit	---

08.27.1002	
	
Alternative Part No	A9452600757
Repair Kit	---

08.29.1007	
	
Alternative Part No	1370084
Repair Kit	---

08.29.1008	
	
Alternative Part No	1368171
Repair Kit	---

08.30.1000	
	
Alternative Part No	20514657
Repair Kit	EKPP.26.7

08.30.1005	
	
Alternative Part No	21707055 21991154
Repair Kit	EKPP.21

08.30.1006	
	
Alternative Part No	1662798
Repair Kit	---

08.30.1007	
	
Alternative Part No	21707054 21991157
Repair Kit	EKPP.22

08.30.1008	
	
Alternative Part No	22327063
Repair Kit	---

08.30.1009	
	
Alternative Part No	22327072
Repair Kit	---

SOLENOID VALVES - OTHER

08.30.1010	
	
Alternative Part No	21596642
Repair Kit	---

	
Alternative Part No	E2810012
Repair Kit	---

08.32.1000	
	
Alternative Part No	1025285/F 20411199
Repair Kit	EKPP.32, EKPP.32.1 or EKPP.32.2

DOOR CONTROL VALVE- WABCO

08.01.V022	
	
Alternative Part No	4726000220
Repair Kit	---

MAN SPLITTER VALVE

08.26.1000	
	
Alternative Part No	81521706156
Repair Kit	---

SOLENOID VALVES KITS - HERION

EKPP.26.8	
	

EKPP.26.9	
	

EKPP.26.10	
	

EKPP.26.11	
	

EKPP.26.12	
	

EKPP.26.13	
	

EKPP.27	
	

SOLENOID VALVES KITS - KNORR BREMSE

EKBO.31	
	

EKBO.32	
	

SOLENOID VALVES

SOLENOID VALVES KITS - MECMAN



SOLENOID VALVES KITS - WABCO



SOLENOID VALVES KITS - OTHER

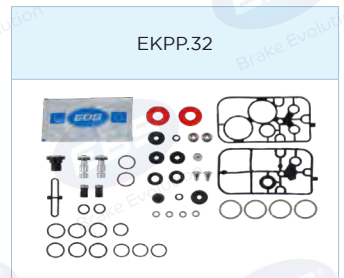

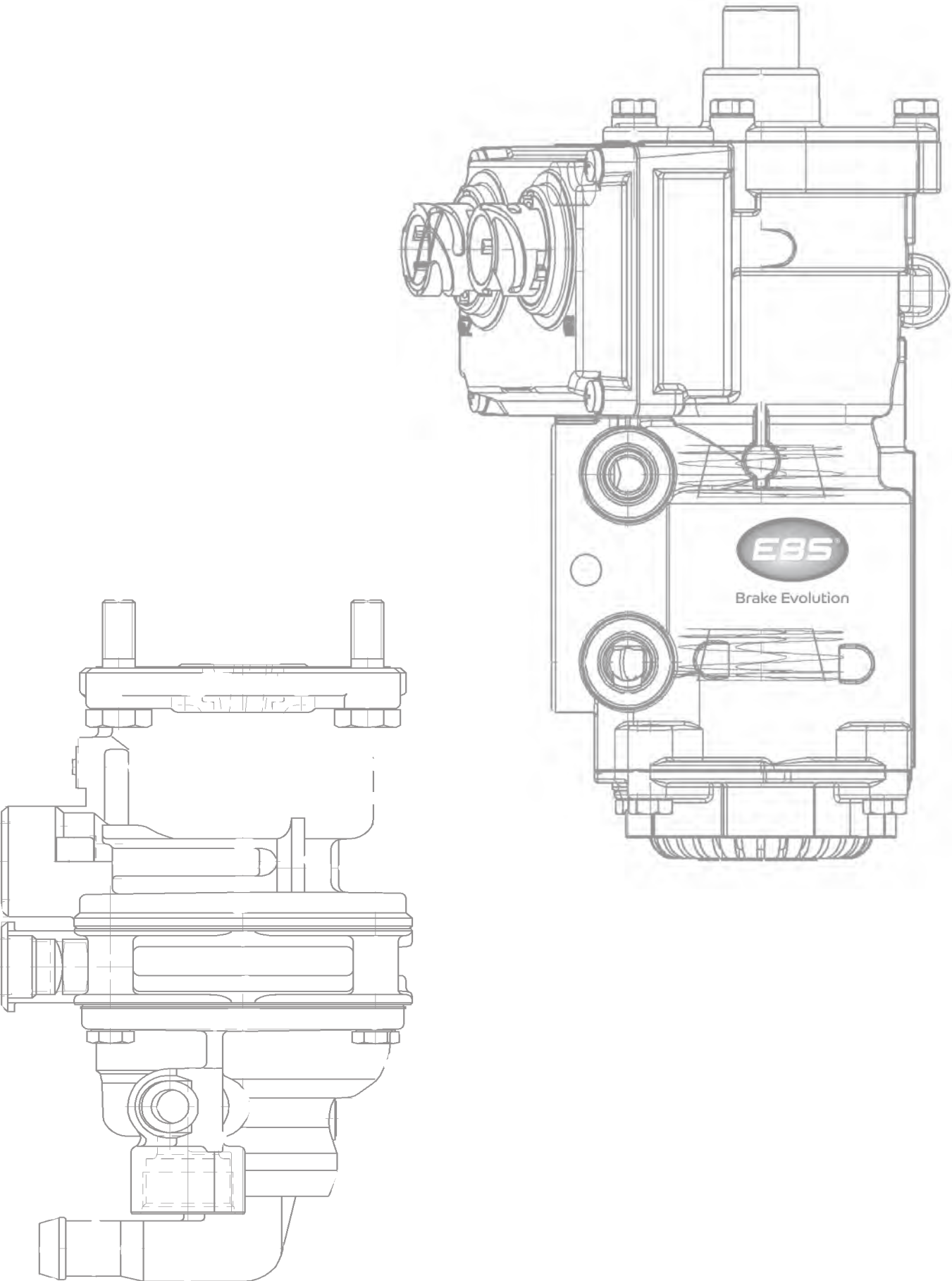

FOOT CONTROL VALVES

EBS FOOT VALVES - BENDIX

R09.06.1013	
	
Alternative Part No	1188768
Repair Kits	EKBE.50 or EKBE.50.C

09.06.1008	
	
Alternative Part No	1189389
Repair Kits	EKBE.50.C or 09.06.1009

	
Alternative Part No	1189492
Repair Kits	EKBE.50 or EKBE.50.C

09.06.1003	
	
Alternative Part No	229501
Repair Kit	EKBE.48

09.06.1004	
	
Alternative Part No	229800
Repair Kit	EKBE.48

09.06.1005	
	
Alternative Part No	277863
Repair Kit	EKBE.48

	
Alternative Part No	279750
Repair Kit	EKBE.49

09.06.1006	
	
Alternative Part No	286171
Repair Kits	EKBE.50 or EKBE.50.C

	
Alternative Part No	286773
Repair Kits	EKBE.51

	
Alternative Part No	286880
Repair Kits	EKBE.50 or EKBE.50.C

	
Alternative Part No	288383
Repair Kits	EKBE.51

09.06.1007	
	
Alternative Part No	295579
Repair Kits	EKBE.50, EKBE.50.C or 09.06.1009

	
Alternative Part No	KX1101/2
Repair Kits	EKBE.52.C

	
Alternative Part No	KX2408/1
Repair Kits	EKBE.52.C

	
Alternative Part No	KX2408/1
Repair Kits	EKBE.52.C

R09.06.1010	
	
Alternative Part No	KY1767/4
Repair Kits	EKBE.50 or EKBE.50.C

EBS FOOT VALVES - BENDIX

R09.06.1014		R09.06.1011		R09.06.1012		---	
							
Alternative Part No	KY1767/2	Alternative Part No	KY1767/5	Alternative Part No	KY1767/8 KY1767/9	Alternative Part No	KY1767/11
Repair Kits	EKBE.50 or EKBE.50C	Repair Kits	EKBE.50 or EKBE.50C	Repair Kits	EKBE.50 or EKBE.50C	Repair Kits	EKBE.50 or EKBE.50C
09.06.1000		09.06.1001		09.06.1002			
							
Alternative Part No	KY1916/1	Alternative Part No	KY1916/3	Alternative Part No	KY1916/4 KY1916/5		
Repair Kit	09.06.1009 EKBE.50 or EKBE.50.C	Repair Kits	EKBE.50 or EKBE.50.C 09.06.1009	Repair Kit	EKBE.65.3 EKBE.50 or EKBE.50.C 09.06.1009		

EBS FOOT VALVES - BOSCH

---		---		---		---	
							
Alternative Part No	0481064002	Alternative Part No	0481064003	Alternative Part No	0481064005	Alternative Part No	0481064006
Repair Kit	EKBO.4	Repair Kit	EKBO.5.4	Repair Kit	EKBO.5	Repair Kit	EKBO.5
---		---		---		09.04.1001	
							
Alternative Part No	0481064011	Alternative Part No	0481064016	Alternative Part No	0481064101	Alternative Part No	0481064103
Repair Kit	EKBO.5	Repair Kit	EKBO.5	Repair Kit	EKBO.5.1	Repair Kit	EKBO.5

FOOT CONTROL VALVES

EBS FOOT VALVES - BOSCH

09.04.1002	
	
Alternative Part No	0481064105 0481064115
Repair Kit	EKBO.5.1

09.04.1003	
	
Alternative Part No	0481064106
Repair Kit	EKBO.5

	
Alternative Part No	0481064107
Repair Kit	EKBO.5

09.04.1000	
	
Alternative Part No	0481064108
Repair Kit	EKBO.5

	
Alternative Part No	0481064110
Repair Kit	EKBO.5.6

	
Alternative Part No	0481064113
Repair Kit	EKBO.5

	
Alternative Part No	0481064201
Repair Kit	EKBO.5

09.04.1004	
	
Alternative Part No	0481064205
Repair Kit	EKBO.5

	
Alternative Part No	0481064206
Repair Kit	EKBO.5

	
Alternative Part No	0481064209
Repair Kit	EKBO.5.6

	
Alternative Part No	0481064210
Repair Kit	EKBO.5.6

	
Alternative Part No	0481064212
Repair Kit	EKBO.5.6

09.04.1006	
	
Alternative Part No	0481064214
Repair Kit	EKBO.5.6

	
Alternative Part No	0481064301
Repair Kit	EKBO.5

	
Alternative Part No	0481064401
Repair Kit	EKBO.5

	
Alternative Part No	0481064405
Repair Kit	EKBO.5.2

EBS FOOT VALVES - BOSCH

	
Alternative Part No	0481064601
Repair Kit	EKBO.5.2

09.04.1005	
	
Alternative Part No	0481064603
Repair Kit	EKBO.5.9C

	
Alternative Part No	0481064701
Repair Kit	EKBO.5.2

	
Alternative Part No	0481064702
Repair Kit	EKBO.5.2

	
Alternative Part No	0486200002
Repair Kit	EKBO.5.9C

09.04.2002	
	
Alternative Part No	0486200008
Repair Kit	EKBO.5.9C

	
Alternative Part No	0486200009
Repair Kit	EKBO.5.9C

09.04.2001	R09.04.2001
	
Alternative Part No	0486200004
Repair Kit	EKKB.49.4

	
Alternative Part No	0486200101
Repair Kit	EKKB.49.4

R09.04.2003	
	
Alternative Part No	0486200104X50
Repair Kit	EKKB.49.4

09.04.2000	
	
Alternative Part No	0486200202N50
Repair Kit	EKKB.49.4

FOOT CONTROL VALVES

EBS FOOT VALVES - CLAYTON DEWANDRE

09.09.1000		09.09.1001		---		---	
Alternative Part No	APGA6620	Alternative Part No	APGA6661 9618940097	Alternative Part No	APGA6714/EU	Alternative Part No	APGA6552
Repair Kit	EKCD.5.6	Repair Kit	EKCD.5.6	Repair Kit	EKCD.5.6	Repair Kit	EKCD.5.1

09.09.1003		09.09.1002		09.09.1004		R09.09.1005	
Alternative Part No	APSA7314/1B	Alternative Part No	APSA7314/1EU	Alternative Part No	APSA7616/AEU APSA7616/EU	Alternative Part No	APSA7222
Repair Kit	EKCD.5.4A	Repair Kit	EKCD.5.4A	Repair Kit	---	Repair Kits	EKCD.5.1

R09.09.1006	
Alternative Part No	APGA6566
Repair Kits	EKCD.5.4A

EBS FOOT VALVES - DAHL (PAUL DAHL)

09.08.1000		---	
Alternative Part No	1023275000	Alternative Part No	1023277000
Repair Kit	EKPD.6C	Repair Kit	EKPD.6C

EBS FOOT VALVES - HINO

09.37.1000		09.37.1001	
Alternative Part No	47160-2452	Alternative Part No	47160-3311
Repair Kit	---	Repair Kit	---

EBS FOOT VALVES - GRAU / HALDEX

EBS Part No.	Alternative Part No.	Repair Kit.
09.02.4815	320060001 320060101	EKGH.45.1
09.02.4837	320060103	EKGH.45.1
---	320060111	EKGH.45.1
---	320060113	EKGH.45.1
---	320060122	EKGH.45.1
---	320060123	EKGH.45.1
---	320063121	EKGH.45.1
09.02.4825	320063122	EKGH.45.1



For silencers please see pages 90.8, 90.9

EBS FOOT VALVES - KNORR BREMSE

R09.02.0156		R09.02.0158		09.02.0158		R09.02.0159		09.02.0159		09.02.4419	
											
Alternative Part No	K040156N50	Alternative Part No	K040158N50	Alternative Part No	K040158N50	Alternative Part No	K040159N50	Alternative Part No	MB4419	Alternative Part No	MB4419
Repair Kit	EKKB.49.4	Repair Kit	EKKB.49.4	Repair Kit	EKKB.49.4	Repair Kit	EKKB.49.4	Repair Kit	EKKB.45	Repair Kit	EKKB.45
09.02.4434		R09.02.4512		09.02.4613		R09.02.4469		09.02.4469			
											
Alternative Part No	MB4434	Alternative Part No	MB4512	Alternative Part No	MB4613	Alternative Part No	K044694N50	Alternative Part No	K044694N50	Alternative Part No	K044694N50
Repair Kit	EKKB.45	Repair Kits	EKKB.45	Repair Kit	EKKB.46	Repair Kit	EKKB.49.4	Repair Kit	EKKB.49.4	Repair Kit	EKKB.49.4
R09.02.4928		09.02.4928		R09.02.4696		09.02.4696		R09.02.9530		09.02.9530	
											
Alternative Part No	K024928N50 K024928X50	Alternative Part No	K044696N50	Alternative Part No	K039530N50	Alternative Part No	K039530N50	Alternative Part No	K039544N50	Alternative Part No	K039544N50
Repair Kit	EKKB.49.4	Repair Kit	EKKB.49.4	Repair Kit	EKKB.49.4	Repair Kit	EKKB.49.4	Repair Kit	EKKB.49.4	Repair Kit	EKKB.49.4

FOOT CONTROL VALVES

EBS FOOT VALVES - KNORR BREMSE

R09.02.9546		R09.02.9569 09.02.9569		R09.02.9571 09.02.9571		---	
Alternative Part No	K039546N50	Alternative Part No	K039569N50	Alternative Part No	K039571N50	Alternative Part No	MB4510
Repair Kit	EKKB.49.4-A	Repair Kit	EKKB.49.4	Repair Kit	EKKB.49.4	Repair Kit	EKKB.45
---		---		---		09.02.4629	
Alternative Part No	MB4523	Alternative Part No	MB4477	Alternative Part No	MB4611	Alternative Part No	MB4629
Repair Kit	EKKB.45	Repair Kit	EKKB.45.1	Repair Kit	EKKB.46	Repair Kit	EKKB.46
09.02.4630		---		09.02.4636		---	
Alternative Part No	MB4630	Alternative Part No	MB4631	Alternative Part No	MB4477	Alternative Part No	MB4643
Repair Kit	EKKB.46	Repair Kit	EKKB.46	Repair Kit	EKKB.46	Repair Kit	EKKB.46
---		---		---		09.02.4653	
Alternative Part No	MB4644	Alternative Part No	MB4648	Alternative Part No	MB4649	Alternative Part No	MB4653
Repair Kit	EKKB.46.5	Repair Kit	EKKB.46	Repair Kit	EKKB.46.8	Repair Kit	EKKB.46.2
---		---		---		---	
Alternative Part No	MB4658	Alternative Part No	MB4673	Alternative Part No	MB4674	Alternative Part No	MB4679
Repair Kit	EKKB.46.2	Repair Kit	EKKB.46.3	Repair Kit	EKKB.46.3	Repair Kit	EKKB.46.3

EBS FOOT VALVES - KNORR BREMSE

---		---		09.02.4694		---	
							
Alternative Part No	MB4683	Alternative Part No	MB4690	Alternative Part No	MB4694	Alternative Part No	MB4710
Repair Kit	EKKB.46.3	Repair Kit	EKKB.46.8	Repair Kit	EKKB.46.6	Repair Kit	EKKB.46.1
---		---		---		09.02.4815	
							
Alternative Part No	MB4803	Alternative Part No	MB4805	Alternative Part No	MB4806	Alternative Part No	MB4815
Repair Kit	EKKB.46.3	Repair Kit	EKKB.46.3	Repair Kit	EKKB.46.3	Repair Kit	EKKB.46.3
09.02.4820		09.02.4821		09.02.4825		09.02.4837	
							
Alternative Part No	MB4820	Alternative Part No	MB4821	Alternative Part No	MB4825	Alternative Part No	MB4837
Repair Kit	EKKB.46.3	Repair Kit	EKKB.46.3	Repair Kit	EKKB.46.3	Repair Kit	EKKB.46.3
09.02.4849		---		R09.02.9000			
							
Alternative Part No	MB4847 MB4849	Alternative Part No	MB4852	Alternative Part No	MB9000		
Repair Kit	EKKB.46.8	Repair Kit	EKKB.46.8	Repair Kit	EKKB.49.9		

FOOT CONTROL VALVES

EBS FOOT VALVES - MAGNETI MARELLI

Alternative Part No	DX16B	Alternative Part No	DX16D	Alternative Part No	DX16DY	Alternative Part No	DX19A
Repair Kit	EKMM.7.2	Repair Kit	EKMM.7.2	Repair Kit	EKMM.7.2	Repair Kit	EKMM.7.2
Alternative Part No	DX25A	Alternative Part No	DX26A	Alternative Part No	DX26B	Alternative Part No	DX50A
Repair Kit	---	Repair Kit	EKMM.7.4	Repair Kit	EKMM.7.4	Repair Kit	EKMM.7
Alternative Part No	DX50AX	Alternative Part No	DX51CX	Alternative Part No	DX52B DX52BY	Alternative Part No	DX53AX
Repair Kit	EKMM.7.1	Repair Kit	EKMM.7.1	Repair Kit	EKMM.7.1	Repair Kit	EKMM.7.1
Alternative Part No	DX60A	Alternative Part No	DX61A	Alternative Part No	DX65A	Alternative Part No	DX65B
Repair Kit	EKMM.7.8	Repair Kit	EKMM.7.6	Repair Kit	EKMM.7.7	Repair Kit	EKMM.7.7
Alternative Part No	DX65C	Alternative Part No	DX70A	Alternative Part No	DX70C	Alternative Part No	DX70D
Repair Kit	EKMM.7.7	Repair Kit	EKMM.4.5 or EKMM.4.6	Repair Kit	EKMM.4.5 or EKMM.4.6	Repair Kit	EKMM.4.5 or EKMM.4.6

For silencers please see pages 90.8,90.9

EBS FOOT VALVES - MAGNETI MARELLI

09.07.1002	
	
Alternative Part No	DX75BA
Repair Kit	EKMM.4.5 or EKMM.4.6

09.07.1003	
	
Alternative Part No	DX75BAY
Repair Kit	EKMM.4.4 or EKMM.4.5

	
Alternative Part No	K059199N00 DX75BBA
Repair Kit	EKMM.4.5 or EKMM.4.6

09.07.1004	
	
Alternative Part No	DX75BX
Repair Kit	EKMM.4.4 or EKMM.4.5

	
Alternative Part No	DX80A
Repair Kit	EKMM.4.6 EKMM.4.6EP

09.07.1011	R09.07.1011
	
Alternative Part No	DX80D
Repair Kit	EKMM.4.6 EKMM.4.6EP

09.07.1010	
	
Alternative Part No	DX80E
Repair Kit	EKMM.4.6 EKMM.4.6EP

R09.07.1013	
	
Alternative Part No	DX81E
Repair Kit	EKMM.4.6

09.07.1016	
	
Alternative Part No	DX95BXY
Repair Kit	EKMM.4.4 or EKMM.4.5

09.07.1005	
	
Alternative Part No	DX95BY
Repair Kit	EKMM.4.4 or EKMM.4.5

09.07.1006	
	
Alternative Part No	DX95F
Repair Kit	EKMM.4.4 or EKMM.4.5

09.07.1007	
	
Alternative Part No	DX95FX
Repair Kit	EKMM.4.4 or EKMM.4.5

09.07.1015	
	
Alternative Part No	DX95BY
Repair Kit	EKMM.4.4 OR 4.5

FOOT CONTROL VALVES

For silencers please see pages 90.8,90.9

EBS FOOT VALVES - WABCO

09.01.1419		09.01.1439		09.01.1475		09.01.1479	
Alternative Part No	4613074190	Alternative Part No	4613074390	Alternative Part No	4613074750	Alternative Part No	4613074790
Repair Kits	EKWA.18 EKWA.18.5 or SEKWA.18	Repair Kits	EKWA.18 EKWA.18.5 or SEKWA.18	Repair Kit	EKWA.18 EKWA.18.5 or SEKWA.18	Repair Kit	EKWA.18 EKWA.18.5 or SEKWA.18
09.01.2004		09.01.2008		09.01.2012		09.01.2017	
Alternative Part No	4613150040	Alternative Part No	4613150080 4613150760	Alternative Part No	4613150120	Alternative Part No	4613150170
Repair Kits	EKWA.19.1 or EKWA.19.12	Repair Kits	EKWA.19.1 or EKWA.19.12	Repair Kit	EKWA.19.1 or EKWA.19.12	Repair Kit	EKWA.19.1 or EKWA.19.12
09.01.2018		09.01.2019		09.01.2022		09.01.2023	
Alternative Part No	4613150180	Alternative Part No	4613150190	Alternative Part No	4613150220	Alternative Part No	4613150230
Repair Kits	EKWA.19.1 or EKWA.19.12	Repair Kits	EKWA.19.3	Repair Kits	EKWA.19.1 or EKWA.19.12	Repair Kits	EKWA.19.3



EBS FOOT VALVES - WABCO

09.01.2026		---		09.01.2030		09.01.2036	
							
Alternative Part No	4613150260	Alternative Part No	4613150270	Alternative Part No	4613150300	Alternative Part No	4613150360
Repair Kits	EKWA.19.1 or EKWA.19.12	Repair Kits	EKWA.19.3	Repair Kits	EKWA.19.3 or EKWA.19.17	Repair Kits	EKWA.19.1
09.01.2042		09.01.2043		09.01.2047		09.01.2061	
							
Alternative Part No	4613150420	Alternative Part No	4613150430	Alternative Part No	4613150470	Alternative Part No	4613150610
Repair Kits	EKWA.19.3 or EKWA.19.17	Repair Kits	EKWA.19.3 or EKWA.19.17	Repair Kits	EKWA.19.1 or EKWA.19.12	Repair Kits	EKWA.19.12
09.01.2077		09.01.2070		---		09.01.2082	
							
Alternative Part No	4613150420	Alternative Part No	4613150700	Alternative Part No	4613150810	Alternative Part No	4613150820
Repair Kits	EKWA.19.12	Repair Kits	EKWA.19.12	Repair Kits	EKWA.19.1 or EKWA.19.12	Repair Kits	EKWA.19.12
09.01.2086		09.01.2150		09.01.2154		09.01.2180	
							
Alternative Part No	4613150860	Alternative Part No	4613151500	Alternative Part No	4613151540	Alternative Part No	4613151800
Repair Kits	EKWA.19.12	Repair Kits	EKWA.19.3	Repair Kits	EKWA.19.12	Repair Kits	EKWA.19.10C or EKWA.19.15

For silencers please see pages 90.8, 90.9

FOOT CONTROL VALVES

EBS FOOT VALVES - WABCO

09.01.2247	
Alternative Part No	4613152470
Repair Kits	EKWA.19.16

09.01.2248	
Alternative Part No	4613152480
Repair Kits	EKWA.19.16

09.01.2250	
Alternative Part No	4613152500
Repair Kits	EKWA.19.6

09.01.2258	
Alternative Part No	4613152580
Repair Kits	EKWA.19.6

09.01.2245	
Alternative Part No	4613152450
Repair Kits	EKWA.19.16

Alternative Part No	4613152590
Repair Kits	EKWA.19.6

09.01.2261	
Alternative Part No	4613152610
Repair Kits	EKWA.19.13

09.01.2263	
Alternative Part No	4613152630
Repair Kits	EKWA.19.13

09.01.2264	
Alternative Part No	4613152640
Repair Kits	EKWA.19.13

Alternative Part No	4613152670
Repair Kits	EKWA.19.1

Alternative Part No	4613154740
Repair Kits	EKWA.19.1

09.01.2475	
Alternative Part No	4613154750
Repair Kits	EKWA.19.1

09.01.2479	
Alternative Part No	4613154790
Repair Kits	EKWA.19.3 or EKWA.19.17

09.01.2482	
Alternative Part No	4613154820
Repair Kits	EKWA.19.1

09.01.2490	
Alternative Part No	4613154900
Repair Kits	EKWA.19.1

09.01.2491	
Alternative Part No	4613154910
Repair Kits	EKWA.19.1

EBS FOOT VALVES - WABCO

09.01.2495	
	
Alternative Part No	4613154950
Repair Kits	EKWA.19.1

09.01.2497	
	
Alternative Part No	4613154970
Repair Kits	EKWA.19.1

09.01.7000	
	
Alternative Part No	4613170000
Repair Kits	EKWA.19.1

	
Alternative Part No	4613170010
Repair Kits	EKWA.19.1

	
Alternative Part No	4613170060
Repair Kits	EKWA.19.1

	
Alternative Part No	4613180050
Repair Kits	EKWA.19.17 or EKWA.19.3

R09.01.E025	
	
Alternative Part No	4613180250
Repair Kits	EKWA.19.3 or EKWA.19.17

	
Alternative Part No	4613180590
Repair Kits	EKWA.19.1

	
Alternative Part No	4613186030
Repair Kits	EKWA.19.1

R09.01.E605	
	
Alternative Part No	4613186050
Repair Kits	EKWA.19.3 or EKWA.19.17

09.01.3008	
	
Alternative Part No	4613190080
Repair Kit	EKWA.19.1

09.01.3018	
	
Alternative Part No	4613190180
Repair Kits	EKWA.19.1

09.01.3032	
	
Alternative Part No	4613190320
Repair Kits	EKWA.19.1

	
Alternative Part No	4613190900
Repair Kits	EKWA.19.2

09.01.3250	
	
Alternative Part No	4613192500
Repair Kits	EKWA.19.16

09.01.3260	
	
Alternative Part No	4613192600
Repair Kits	EKWA.19.1

FOOT CONTROL VALVES

EBS FOOT VALVES - WABCO

09.01.3270	
	
Alternative Part No	4613192700
Repair Kits	EKWA.19.2

R09.01.3264	
	
Alternative Part No	4613192640
Repair Kits	EKWA.19.6

09.01.3271	
	
Alternative Part No	4613192710
Repair Kits	EKWA.19.6

09.01.3272	
	
Alternative Part No	4613192720
Repair Kits	EKWA.19.2

09.01.3273	
	
Alternative Part No	4613192730
Repair Kits	EKWA.19.2

09.01.3274	
	
Alternative Part No	4613192700
Repair Kits	EKWA.19.2

	
Alternative Part No	4613192750
Repair Kits	EKWA.19.6

	
Alternative Part No	4613192800
Repair Kits	EKWA.19.6

	
Alternative Part No	4613192750
Repair Kits	EKWA.19.6

	
Alternative Part No	4613197010
Repair Kits	EKWA.19.1

	
Alternative Part No	4613197020
Repair Kits	EKWA.19.1

R09.01.4018	
	
Alternative Part No	4613240180
Repair Kits	EKWA.19.3 or EKWA.19.17

09.01.4520	
	
Alternative Part No	4613245200
Repair Kits	EKWA.19.8

	
Alternative Part No	4613280000
Repair Kits	EKWA.19.1

	
Alternative Part No	4614911000
Repair Kits	EKWA.18 or SEKWA.18

09.01.5102	
	
Alternative Part No	4614911020
Repair Kits	EKWA.18 or SEKWA.18

For silencers please see pages 90.8, 90.9

EBS FOOT VALVES - WABCO

	
Alternative Part No	4614940010
Repair Kits	EKWA.21

	
Alternative Part No	4614940200
Repair Kits	EKWA.21

	
Alternative Part No	4614941000
Repair Kits	EKWA.21

	
Alternative Part No	4614941090
Repair Kits	EKWA.19.12

	
Alternative Part No	4614941100
Repair Kits	EKWA.19.11

09.01.6500	
	
Alternative Part No	4614945000
Repair Kits	EKWA.19.11

09.01.6501	
	
Alternative Part No	4614945010
Repair Kits	EKWA.19.11

09.01.6502	
	
Alternative Part No	4614945020
Repair Kits	EKWA.19.11

09.01.6509	
	
Alternative Part No	4614945090
Repair Kits	EKWA.19.11

09.01.6510	
	
Alternative Part No	4614945100
Repair Kits	EKWA.19.11

09.01.6511	
	
Alternative Part No	4614945110
Repair Kits	EKWA.19.11

09.01.6512	
	
Alternative Part No	4614945120
Repair Kits	EKWA.19.11

	
Alternative Part No	4614940240
Repair Kits	EKWA.20

	
Alternative Part No	4614990050
Repair Kits	EKWA.20

09.01.9000	
	
Alternative Part No	4700120000
Repair Kits	EKWA.18 EKWA18.5 or EKWA18.4c

	
Alternative Part No	4800010000
Repair Kits	EKWA.19.14

FOOT CONTROL VALVES

EBS FOOT VALVES - WABCO

---		09.01.A010		09.01.A011		---	
							
Alternative Part No	4800010050	Alternative Part No	4800010100	Alternative Part No	4800010110	Alternative Part No	4800013000
Repair Kits	EKWA.19.14	Repair Kits	EKWA.19.14	Repair Kits	EKWA.19.14	Repair Kits	EKWA.19.14
09.01.A500		---		09.01.C000		09.01.C004	
							
Alternative Part No	4800015000	Alternative Part No	4800200100	Alternative Part No	4800030000	Alternative Part No	4800030040
Repair Kits	EKWA.19.14	Repair Kits	EKWA.19.50	Repair Kits	EKWA.19.48	Repair Kits	EKWA.19.48
09.01.C039		---		09.01.8001		09.01.8002	
							
Alternative Part No	4800030390	Alternative Part No	4800200200 4800200260	Alternative Part No	9650010012	Alternative Part No	9650010022
Repair Kits	---	Repair Kits	EKWA.19.49	Repair Kits	EKWA.19.11 or EKWA.19.11A	Repair Kits	EKWA.19.11 or EKWA.19.11A
09.01.8005		09.01.10000		R09.01.8010			
							
Alternative Part No	9650010052	Alternative Part No	9650010102				
Repair Kits	EKWA.19.11 or EKWA.19.11A	Repair Kits	EKWA.19.11 or EKWA.19.11A				

For silencers please see pages 90.8, 90.9









EBS FOOT VALVES - WILLIAMS

09.10.1000		09.10.1001	
			
Alternative Part No	WM543	Alternative Part No	WM90
Repair Kits	---	Repair Kits	---

EBS BENDIX KITS

				
			 Complete Treadle	 Cover Only

EBS BOSCH KITS

FOOT CONTROL VALVES

EBS CLAYTON DEWANDRE KITS



EBS DAHL (PAUL DAHL) KITS



EBS GRAU / HALDEX KITS



EBS KNORR BREMSE KITS



EBS MAGNETTI MARELLI KITS



EBS WABCO KITS

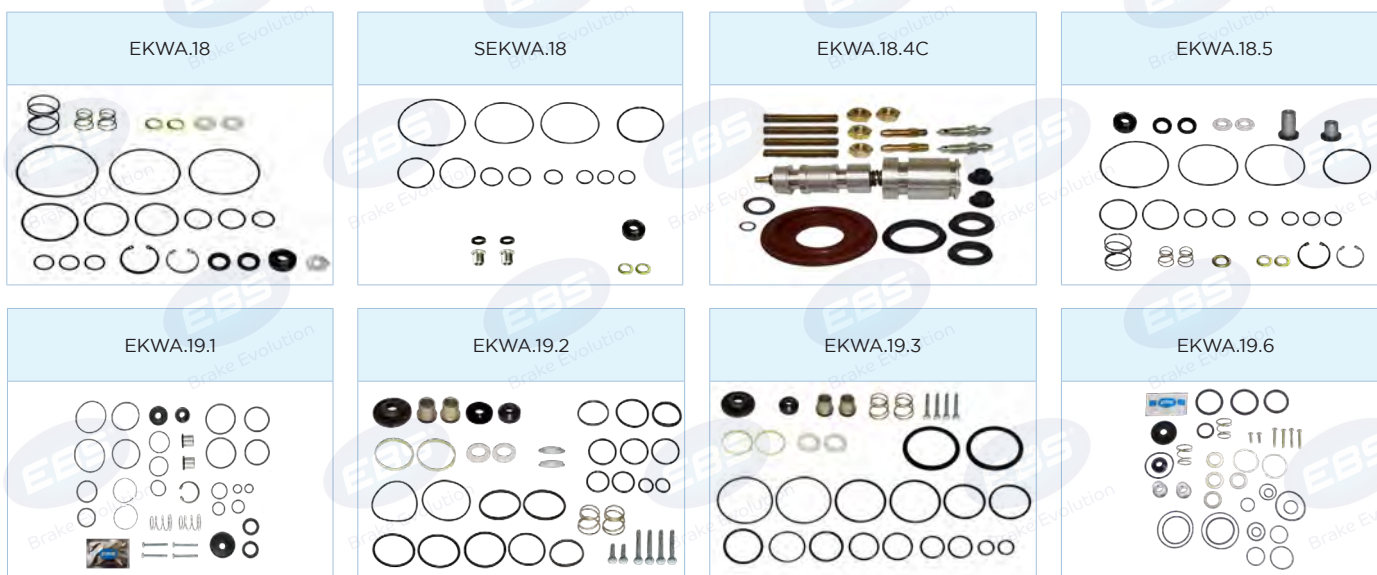

FOOT CONTROL VALVES

EBS WABCO KITS

EKWA.19.8



EKWA.19.10C



EKWA.19.11



EKWA.19.11A



EKWA.19.12

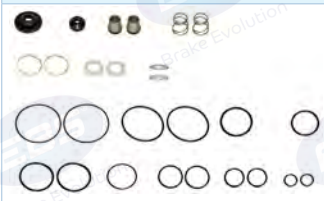

EKWA.19.13



EKWA.19.14



EKWA.19.15



EKWA.19.16



EKWA.19.17



EKWA.19.48



EKWA.19.49



EKWA.19.50



EKWA.19.TC



EKWA.20



EKWA.21



90.01.2202



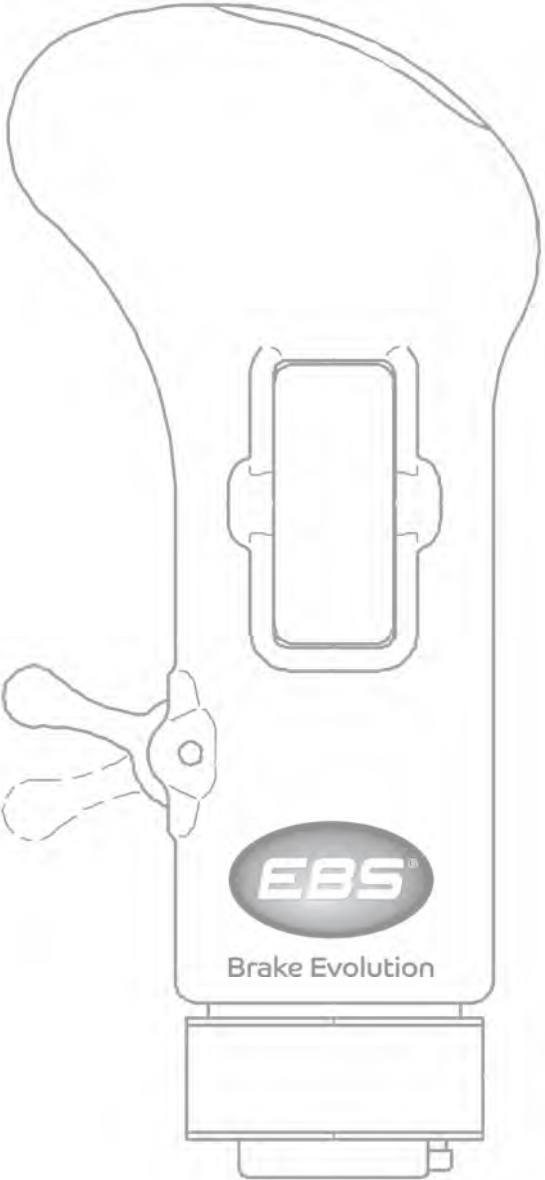
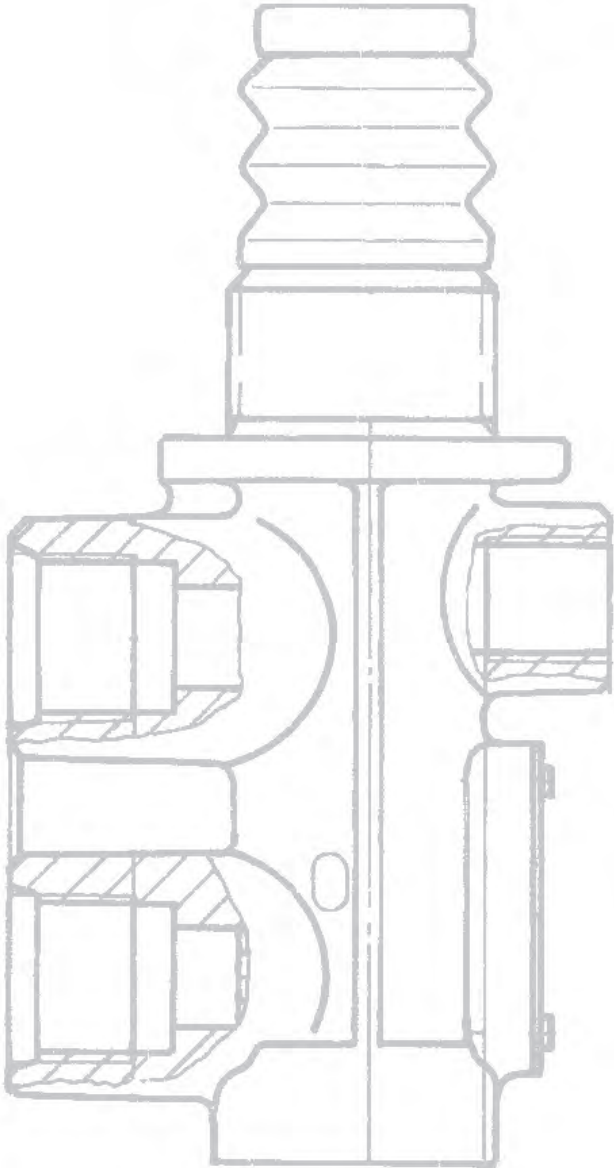



EBS GEARBOX VALVES

10.01.1112		10.01.1114		10.01.1116		10.01.1122	
Alternative Part No	4630131120 179713	Alternative Part No	4630131140 AE1207 178964	Alternative Part No	4630131160	Alternative Part No	4630131220
Description	GEARBOX THREE WAY VALVE	Description	GEARBOX THREE WAY VALVE	Description	GEARBOX THREE WAY VALVE	Description	GEARBOX THREE WAY VALVE
Repair Kit	EKWA.24.1	Repair Kit	EKWA.24.1	Repair Kit	EKWA.24.1	Repair Kit	EKWA.24.1
10.01.1126		10.01.1130		10.01.1200		10.01.1210	
Alternative Part No	4630131260	Alternative Part No	4630131300	Alternative Part No	4630132000	Alternative Part No	4630132100
Description	GEARBOX THREE WAY VALVE	Description	GEARBOX THREE WAY VALVE	Description	GEARBOX THREE WAY VALVE	Description	GEARBOX THREE WAY VALVE
Repair Kit	---	Repair Kit	---	Repair Kit	EKWA.24.1	Repair Kit	EKWA.24.1
10.01.6111		10.01.8004		---		10.01.9002	
Alternative Part No	4630281110	Alternative Part No	4630460040	Alternative Part No	4630620000	Alternative Part No	4630630020 4630630030
Description	GEARBOX VALVE	Description	GEARBOX MAIN SHUT OFF VALVE	Description	GEARBOX PILOT VALVE	Description	GEARBOX AIR DIRECTIONAL CONTROL VALVE
Repair Kit	EKWA.23.3	Repair Kit	EKWA.23.1	Repair Kit	EKWA.23.2	Repair Kit	EKWA.23.5

EBS GEARBOX VALVES

10.02.3302		10.02.3336		10.02.3360	
					
Alternative Part No	SV3302 I85043	Alternative Part No	SV3336 I87893	Alternative Part No	SV3360 I79678
Description	GEARBOX MAIN SHUT OFF VALVE	Description	GEARBOX MAIN SHUT OFF VALVE	Description	GEARBOX MAIN SHUT OFF VALVE
Repair Kit	EKKB.23.1	Repair Kit	---	Repair Kit	EKKB.23.1
10.02.3367		10.02.3368		10.02.3371	
					
Alternative Part No	SV3367 I76936	Alternative Part No	SV3368 I87538	Alternative Part No	SV3371
Description	GEARBOX PILOT VALVE	Description	GEARBOX PILOT VALVE	Description	GEARBOX VALVE
Repair Kit	EKKB.23.2	Repair Kit	EKKB.23.2A	Repair Kit	---
10.10.1000		10.10.1000		10.10.1000	
					
Alternative Part No	99100180008	Alternative Part No	99100180008	Alternative Part No	99100180008
Description	EXHAUS DAMPER (STEYR)	Description	EXHAUS DAMPER (STEYR)	Description	EXHAUS DAMPER (STEYR)
Repair Kit	---	Repair Kit	---	Repair Kit	---
10.21.1000		10.21.1001		10.21.1002	
					
Alternative Part No	1297004 93190556 81327346044	Alternative Part No	1609886	Alternative Part No	1786995
	DAF IVECO MAN				
	7421318366 21318366				
	RENAULT VOLVO				
Description	GEARBOX SPLITTER VALVE				
Repair Kit	---				
10.21.1003		10.26.1000		10.27.1000	
					
Alternative Part No	1154219	Alternative Part No	81.32550.6016	Alternative Part No	5000673571
Description	GEARBOX SHIFTING VALVE	Description	MAN GEARBOX VALVE	Description	AUXILIARY GEARBOX VALVE
Repair Kit	---	Repair Kit	EKPP.23 EKPP.23.C	Repair Kit	EKPP.33
10.27.1001		10.27.1001		10.27.1001	
					
Alternative Part No	0012603557 0012608457	Alternative Part No	0012603557 0012608457	Alternative Part No	0012603557 0012608457
Description	GEARBOX VALVE	Description	GEARBOX VALVE	Description	GEARBOX VALVE
Repair Kit	---	Repair Kit	---	Repair Kit	---

GEARBOX VALVES

EBS GEARBOX VALVES

10.27.1002	
	
Alternative Part No	0022606157
Description	GEARBOX SPLITTER VALVE
Repair Kit	---

10.27.1003	
	
Alternative Part No	0022606257
Description	GEARBOX SPLITTER VALVE
Repair Kit	---

10.27.1004	
	
Alternative Part No	0012602057
Description	GEARBOX SPLITTER VALVE
Repair Kit	---

GEARBOX VALVES - MERCEDES

10.27.2001	
	
Alternative Part No	A0022604657
Repair Kit	---

10.27.1005	
	
Alternative Part No	A0022607457
Repair Kit	---

GEARBOX VALVES - VOLVO

10.30.1007	
	
Alternative Part No	1653070
Repair Kit	---

10.30.1001			
			
Alternative Part No	1653360 1521247 1527590 1527591	1654350 1669419 267858	
Repair Kit	---		

10.30.1002	
	
Alternative Part No	1521248 1669420
Repair Kit	---

10.30.1006	
	
Alternative Part No	3192384
Repair Kit	---

10.30.1003	
	
Alternative Part No	20775168 8171245
Repair Kit	---

10.30.1000	
	
Alternative Part No	20775173 8171247
Repair Kit	---

10.30.1005	
	
Alternative Part No	20783875
Repair Kit	---

GEARBOX VALVES - ZF

10.42.1001	
	
Alternative Part No	0501219315
Repair Kit	EKPP.42.1

GEARBOX INHIBITOR VALVES

10.29.1000		10.30.1012		10.30.1010		10.30.1011	
							
Alternative Part No	1319557	Alternative Part No	1653156	Alternative Part No	1669297 1068951	Alternative Part No	1669298 1068952
Description	(Scania)	Description	(Volvo)	Description	(Volvo)	Description	(Volvo)
Repair Kit	EKPP.26.3	Repair Kit	EKPP.26.17	Repair Kit	EKPP.26.2	Repair Kit	EKPP.26.4
10.30.1008		10.30.1009		10.30.1013		10.30.1014	
							
Alternative Part No	1669324 3091916	Alternative Part No	1672231	Alternative Part No	8172628	Alternative Part No	1521249
Description	(Volvo)	Description	(Volvo)	Description	(Volvo)	Description	(Volvo)
Repair Kit	EKPP.26.1	Repair Kit	EKPP.26.1	Repair Kit	EKPP.26.1	Repair Kit	EKPP.26.14

GEARBOX VALVES

GEARBOX ACTUATORS

10.01.3082	
	
Alternative Part No	4213520820
Description	Gearbox Actuator
Repair Kit	---

GEARBOX CYLINDER

10.01.10000	
	
Alternative Part No	4213500870
Description	Gearbox 3 Position Cylinder
Repair Kit	---

EBS GEAR SHIFT KNOBS

10.02.059	
	
Alternative Part No	1285259 4630850200
Application	DAF

10.02.060	
	
Alternative Part No	1285260 4630850000
Application	DAF

10.02.058	
	
Alternative Part No	1833030 4630850400
Application	DAF

10.06.043	
	
Alternative Part No	81326200043
Application	MAN

10.06.044	
	
Alternative Part No	81326200044
Application	MAN

10.06.045	
	
Alternative Part No	81326200045
Application	MAN

10.06.055	
	
Alternative Part No	81326200055
Application	MAN

10.06.091	
	
Alternative Part No	81.32620.0091
Application	MAN

10.06.095	
	
Alternative Part No	81.32620.0095
Application	MAN

10.06.009	
	
Alternative Part No	81970106009
Application	MAN

10.06.010	
	
Alternative Part No	81970106010
Application	MAN

10.06.011	
	
Alternative Part No	81970106011
Application	MAN

EBS GEAR SHIFT KNOBS

10.06.013	
	
Alternative Part No	81970106013
Application	MAN

10.03.098	
	
Alternative Part No	1309315 1369975
Application	SCANIA

10.03.055	
	
Alternative Part No	1318858 1369555 1485717
Application	SCANIA

10.03.097	
	
Alternative Part No	1362071 1482992 1482997
Application	SCANIA

10.03.096	
	
Alternative Part No	1369977 1482996
Application	SCANIA

10.03.056	
	
Alternative Part No	1377386
Application	SCANIA

10.03.077	
	
Alternative Part No	1438702 1727377 1919065
Application	SCANIA

10.03.070	
	
Alternative Part No	384970
Application	SCANIA

10.04.052	
	
Alternative Part No	20488052 20493844 1521394 1655855 3192255
Application	VOLVO
	REPAIR KIT EKWA.25.4

10.04.058	
	
Alternative Part No	20488058 20488079 1673109 276634
Application	VOLVO
	276826 276832 3192256

10.04.063	
	
Alternative Part No	20488063 1527004 1672299
Application	VOLVO
	276313 276825 3192261

10.04.065	
	
Alternative Part No	20488065 8171386
Application	VOLVO

GEARBOX VALVES

EBS GEAR SHIFT KNOBS

10.04.066	
	
Alternative Part No	20488061
Application	VOLVO

10.04.853	
	
Alternative Part No	4630490500
Application	VOLVO

10.04.855	
	
Alternative Part No	1526865 4630490010
Application	VOLVO

10.04.854	
	
Alternative Part No	4630550500
Application	VOLVO

10.04.856	
	
Alternative Part No	1665981 4630550520
Application	VOLVO

EBS GEAR I-SHIFT KNOBS

10.27.109	
	
Alternative Part No	9432601109
Application	MERCEDES BENZ RHD

10.27.209	
	
Alternative Part No	A9432601209 9432601209 9432600209 9432600809 9305841138 4331550020
Application	MERCEDES BENZ LHD

10.27.298	
	
Alternative Part No	4331500200 0002603298
Application	MERCEDES BENZ LHD

EBS GEAR I-SHIFT KNOBS

10.27.309	
	
Alternative Part No	9432601309
Application	MERCEDES BENZ RHD

10.27.398	
	
Alternative Part No	0002603398
Application	MERCEDES BENZ RHD

10.27.509	
	
Alternative Part No	9432601509 9432601609
Application	MERCEDES BENZ LHD

10.30.913		
		
Alternative Part No	22647913 21937971 21024533	21024539 21073035 21456378
Application	VOLVO/RHD	
Information	10 wire cable	

10.30.920		
		
Alternative Part No	21937969 21073025 21024535	21456377 20709205 20483920
Application	VOLVO/LHD	
Information	10 wire cable	

10.30.048	
	
Alternative Part No	22583048
Application	VOLVO/ LHD

10.30.926	
	
Alternative Part No	22647926
Application	VOLVO/ LHD

GEARBOX VALVES

EBS GEARBOX VALVES REPAIR KITS

<p>EKKB.23.1</p>	<p>EKKB.23.2</p>	<p>EKKB.23.2A</p>	<p>---</p>
<p>EKPP.23</p>	<p>EKPP.23.C</p>	<p>EKPP.33</p>	<p>EKPP.42.1</p>

GEARBOX ACTUATOR VALVES REPAIR KITS

<p>EKWA.1.1</p>	<p>EKWA.2</p>	<p>EKWA.2.2</p>	<p>EKWA.23.1</p>				
<p>EKWA.23.2</p>	<p>EKWA.23.3</p>	<p>EKWA.23.5</p>	<p>EKWA.24.1</p>				
<p>EKWA.25.4</p>	<p>EKWA.34</p>	<p>10.30.1004</p> <p>AIR CONNECTOR FOR GEARBOX VALVE</p> <table border="1" data-bbox="815 1771 1144 1821"> <tr> <td>Alternative Part No</td> <td>1395692 1521249</td> </tr> </table>	Alternative Part No	1395692 1521249	<p>EKWA.10009</p> <table border="1" data-bbox="1166 1771 1495 1821"> <tr> <td>Alternative Part No</td> <td>4213559422</td> </tr> </table>	Alternative Part No	4213559422
Alternative Part No	1395692 1521249						
Alternative Part No	4213559422						

EKWA.10010

GEARBOX INHIBITOR VALVES REPAIR KITS



GEARBOX VALVES

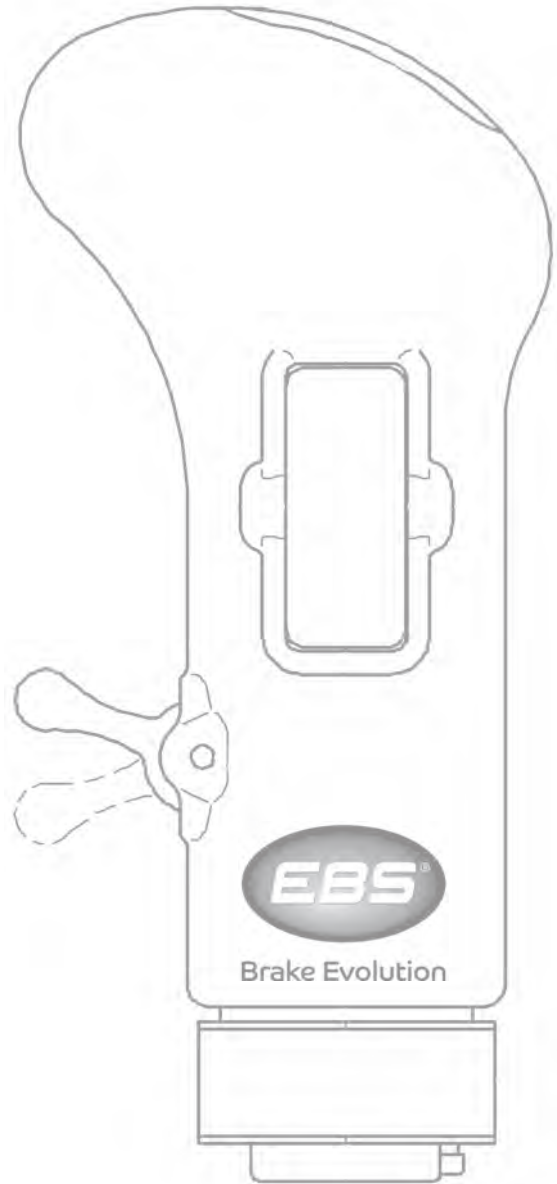
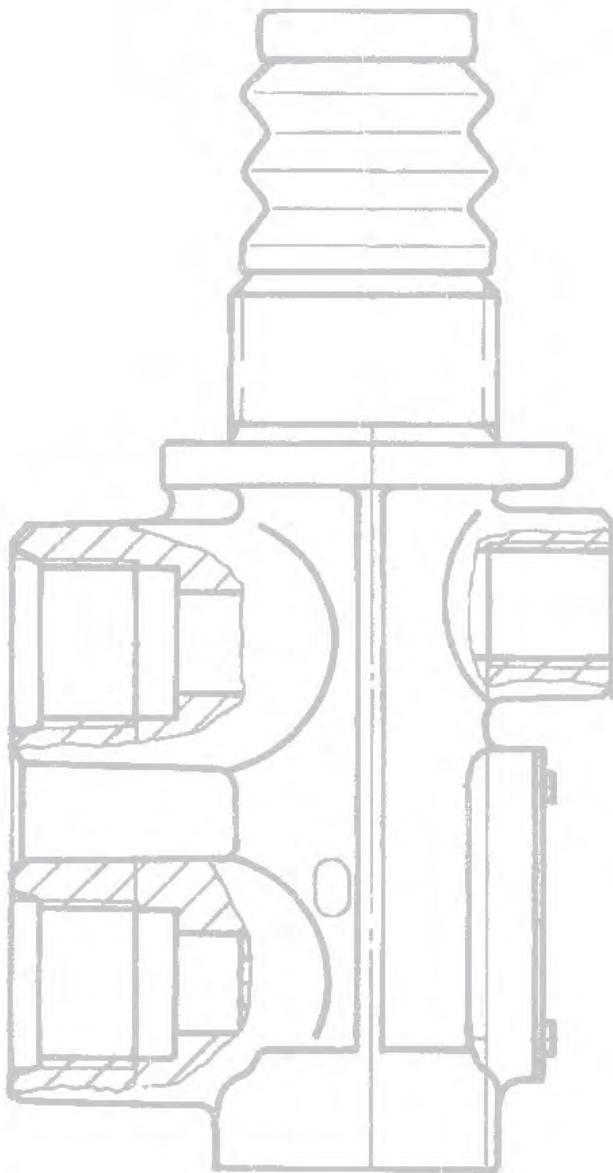

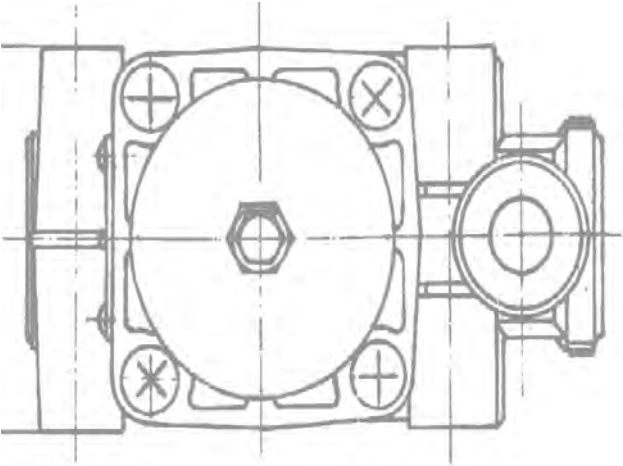
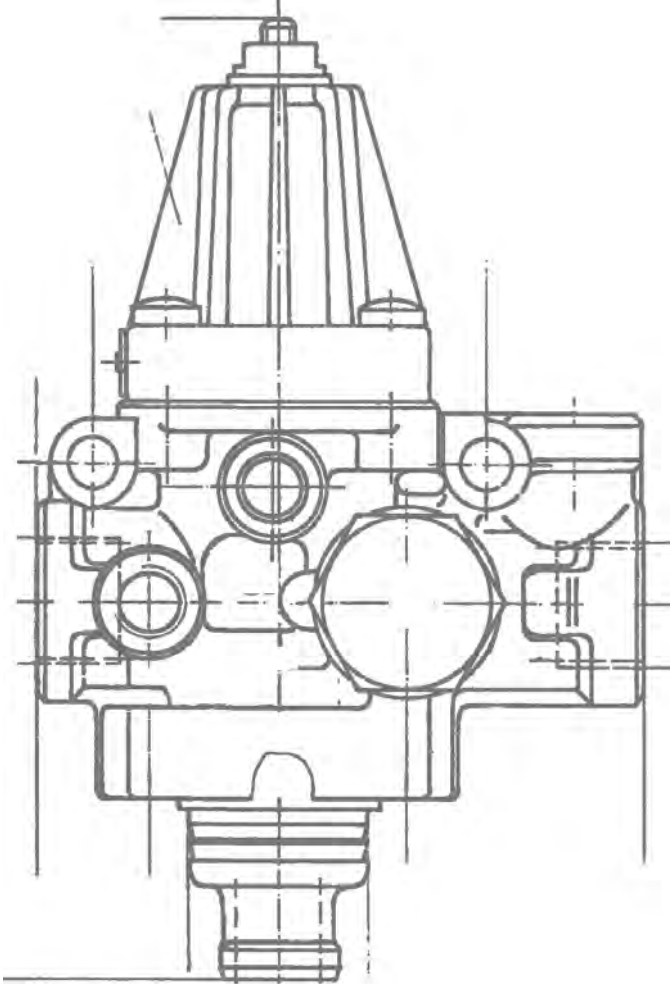

UNLOADER & GOVERNOR VALVES

EBS BENDIX D2 GOVERNOR VALVES

EBS Part No	Alternative Part No	Type	Repair Kit
11.06.1000	1189392000	1/8" NPTF 7.9 BAR	EKBE.37.1
11.06.1001	1189393000	M10 7.9 BAR	
11.06.1002	1189394000	M10 8.1 BAR	
11.06.1003	1189395000 267098	M10 8.6 BAR	
11.06.1004	1189396000	M10 12 BAR	
11.06.1005	1189489000 267101	M10 10 BAR	
11.06.1006	267051	M10 9 BAR	
11.06.1007	1185145	1/4" NPTF 8.4 BAR	
11.06.1008	275200DK	1/8" NPTF 7.2 BAR	
11.06.1009	275491DK	1/8" NPTF 8.3 BAR	
11.06.1010	275508DK	1/8" NPTF 7.6 BAR	
11.06.1011	277486DK	1/8" NPTF 9 BAR	
11.06.1012	269733	1/8" NPTF 7.8 BAR	

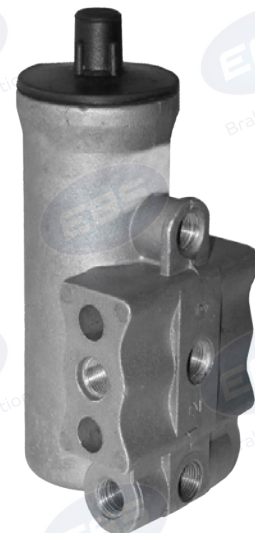

EBS CLAYTON DEWANDRE / WABCO GOVERNOR VALVES

---		---		---		---	
							
Alternative Part No	APSA2870	Alternative Part No	APSA9000/A 9754000390	Alternative Part No	APSA9006/2	Alternative Part No	APSA9006/5
Repair Kit	EKCD.8.2	Repair Kit	EKCD.8.2	Repair Kit	EKCD.8.2	Repair Kit	EKCD.8.2
---		---		---		---	
							
Alternative Part No	APSA9018	Alternative Part No	APSA9042	Alternative Part No	9754000830	Alternative Part No	9754000940
Repair Kit	EKCD.8.2	Repair Kit	EKCD.8.2	Repair Kit	---	Repair Kit	EKCD.8.2

EBS BOSCH UNLOADER VALVES

EBS Part No.	Alternative Part No.	Repair Kit	Image
---	0481039101	EKBO.9	A
---	0481039102	EKBO.9	A
---	0481039104	EKBO.9	A
---	0481039105	EKBO.9	A
---	0481039106	EKBO.9	A
---	0481039116	EKBO.9	A
---	0481039117	EKBO.9	A
---	0481042101	EKBO.9	A
---	0481042102	EKBO.9	A
---	0481042103	EKBO.9	A
---	0481042104	EKBO.9	A
---	0481042105	EKBO.9	A

EBS Part No.	Alternative Part No.	Repair Kit	Image
---	0481042106	EKBO.9	A
---	0481042107	EKBO.9	A
---	0481042108	EKBO.9	A
---	0481039201000	EKBO.9.1	B
---	0481039202000	EKBO.9.1	B
---	0481039204000	EKBO.9.1	B
11.04.1002	0481039209000	EKBO.9.1	B
11.04.1001	0481039210000	EKBO.9.1	B
11.04.1003	0481039211000	EKBO.9.1	B
11.04.1004	0481039213000	EKBO.9.1	B
---	0481039214000	EKBO.9.1	B
---	0481039216000	EKBO.9.1	B
---	0481039219000	EKBO.9.1	B
11.04.1005	0481039221000	EKBO.9.1	B
---	0481039222000	EKBO.9.1	B
11.04.1006	0481039225000	EKBO.9.1	B
11.04.1007	0481039237000	EKBO.9.1	B
11.04.1008	0481039214000	EKBO.9.1	B
---	0481039260000	EKBO.9.1	B
---	0481039268000	EKBO.9.1	B
11.04.1002	0481039269000	EKBO.9.1	B
---	0481039273000	EKBO.9.1	B
---	0481042201000	EKBO.9.1	B
---	0481042211000	EKBO.9.1	B
---	0481042212000	EKBO.9.1	B
11.04.1000	0481042214090	EKBO.9.1	B
---	0481042225000	EKBO.9.1	B



EBS CLAYTON DEWANDRE UNLOADER VALVES

---	---	---
Alternative Part No	APSA2878	
Repair Kit	EKCD.8.1	

EBS HALDEX UNLOADER VALVES

---	---	---
Alternative Part No	312013014	
Repair Kit	EKGH.61.1	

UNLOADER & GOVERNOR VALVES

EBS KNORR BREMSE UNLOADER VALVES

11.02.1000		---		---		11.02.1001		11.02.1002	
Alternative Part No	DR3200	Alternative Part No	DR3231	Alternative Part No	DR3224	Alternative Part No	DR3500	Alternative Part No	DR3502
Repair Kit	EKKB.5	Repair Kit	EKKB.5	Repair Kit	EKKB.5	Repair Kit	EKKB.5.2	Repair Kit	EKKB.5.2
---		---		11.07.1000		---			
Alternative Part No	DR3515	Alternative Part No	DR3524	Alternative Part No	AC135HYZ	Alternative Part No	DR33A		
Repair Kit	EKKB.5.2	Repair Kit	EKKB.5.2	Repair Kit	EKMM.61.1	Repair Kit	EKMM.6		

EBS WABCO UNLOADER VALVES

N133.527FA		---		---		11.01.1256		11.01.2110	
Alternative Part No	0024551207 1335270008	Alternative Part No	4753042010	Alternative Part No	4753042510	Alternative Part No	4753042560	Alternative Part No	9753001100
Repair Kit	EKWA.61.3A	Repair Kit	EKWA.37 or EKWA.37.1	Repair Kit	EKWA.37 or EKWA.37.1	Repair Kit	EKWA.37 or EKWA.37.1	Repair Kit	EKWA.61 SEKWA.61

EBS Part No	Alternative Part No		EBS Part No	Alternative Part No
11.01.3000	9753030000		11.01.3446	9753034460
11.01.3040	9753030400		11.01.3447	9753034470
11.01.3060	9753030600		11.01.3464	9753034640
11.01.3061	9753030610		11.01.3465	9753034650
11.01.3072	9753030720		11.01.3469	9753034690
11.01.3081	9753030810		11.01.3472	9753034720
11.01.3082	9753030820		11.01.3473	9753034730
11.01.3083	9753030830		11.01.3474	9753034740
11.01.3086	9753030860		11.01.3479	9753034790
11.01.3504	9753030890		11.01.3480	9753034800
11.01.3091	9753030910		11.01.3490	9753034900
11.01.3120	9753031200		11.01.3491	9753034910
11.01.3121	9753031210		11.01.3503	9753035030
11.01.3141	9753031410		11.01.3504	9753035040
11.01.3220	9753032200		11.01.3541	9753035410
11.01.3441	9753034410		11.01.3580	9753035800
11.01.3442	9753034420		11.01.3661	9753036610

EKWA.61.1A or
SEKWA.61.1

EKWA.61.1A or
SEKWA.61.1

EBS BENDIX D2 GOVERNOR VALVES KITS



EBS CLAYTON D/ WABCO GOVERNOR VALVES KITS



EBS BOSCH UNLOADER VALVES KITS



EBS CLAYTON DEWANDRE UNLOADER VALVES KITS



EBS HALDEX UNLOADER VALVES KITS



EBS KNORR BREMSE UNLOADER VALVES KITS

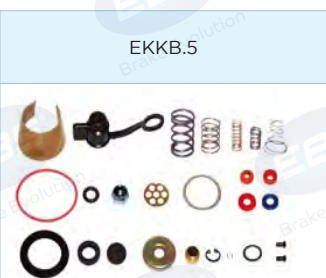

EBS MAGNETI MARELLI UNLOADER VALVES KITS



UNLOADER & GOVERNOR VALVES

EBS WABCO UNLOADER VALVES KITS

EKWA.37



EKWA.37.1



EKWA.61



EKWA.61.1A



EKWA.61.3A



SEKWA.61



SEKWA.61.1



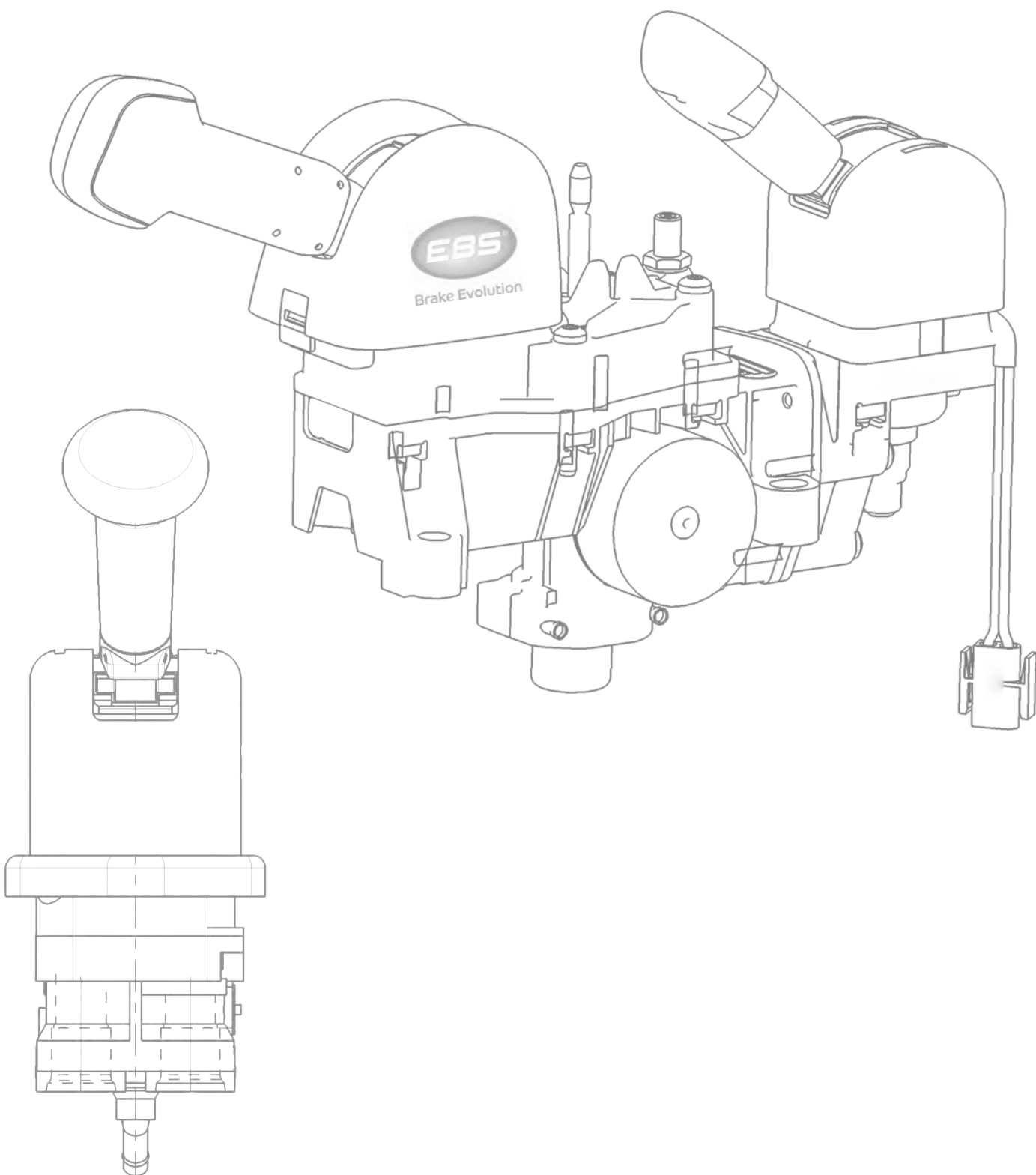

HAND CONTROL VALVES

EBS BERTOCCHI HAND VALVES

---		---	
Alternative Part No	D1252000	Alternative Part No	D1253060
Repair Kit	---	Repair Kit	---

EBS BOSCH HAND VALVES

12.04.1000	---	---	---
Alternative Part No	0481016019	Alternative Part No	0481016024
Repair Kit	EKBO.5.7	Repair Kit	EKKB.2
---	---	---	---
Alternative Part No	0481016113	Alternative Part No	0481016201
Repair Kit	EKBO.54.1	Repair Kit	EKBO.54.2
---	---	---	---
Alternative Part No	0481016308	Alternative Part No	0481016309
Repair Kit	EKBO.54.2	Repair Kit	EKBO.54.2
---	---	---	---
Alternative Part No	0481016302	Alternative Part No	0481016401
Repair Kit	EKBO.54.1	Repair Kit	EKBO.54.2
---	---	---	---
Alternative Part No	0481016603	Alternative Part No	0481016601
Repair Kit	EKBO.54.3	Repair Kit	EKBO.54.1
---	---	---	---
Alternative Part No	0481016702	Alternative Part No	0481016702
Repair Kit	EKBO.54.2	Repair Kit	EKBO.54.2

EBS BENDIX HAND VALVES

12.06.1000		12.06.1001		12.06.1002	
					
Alternative Part No	KX2006/1	Alternative Part No	1194220000	Alternative Part No	1194403
Repair Kit	---	Repair Kit	---	Repair Kit	---

EBS CLAYTON DEWANDRE HAND VALVES

12.09.1000	
	
Alternative Part No	APGA6635/A
Repair Kit	EKCD.54

EBS PAUL DAHL HAND VALVES

12.08.1000		---	
			
Alternative Part No	1043110000	Alternative Part No	1043130000
Repair Kit	EKPD.52	Repair Kit	EKPD.52

EBS KNORR BREMSE HAND VALVES

---		---		12.02.1143		---		12.02.1147	
									
Alternative Part No	HB1133	Alternative Part No	HB1142	Alternative Part No	HB1143	Alternative Part No	HB1144	Alternative Part No	HB1147
Repair Kit	EKKB.54.1	Repair Kit	EKKB.54.1	Repair Kit	EKKB.54.1	Repair Kit	EKKB.54.1	Repair Kit	EKKB.54.1
---		---		---		---		12.02.1176	
Alternative Part No	HB1170	Alternative Part No	HB1170	Alternative Part No	HB1172	Alternative Part No	HB1175	Alternative Part No	HB1176
Repair Kit	EKKB.54.1	Repair Kit	EKKB.54.1	Repair Kit	EKKB.54.1	Repair Kit	EKKB.54.1	Repair Kit	EKKB.54.1

	
Alternative Part No	HB1189
Repair Kit	EKKB.54.1

	
Alternative Part No	HB1179
Repair Kit	EKKB.54.1

	
Alternative Part No	HB1204
Repair Kit	EKKB.54.3

	
Alternative Part No	HB1240
Repair Kit	EKKB.54.3

12.02.1241	
	
Alternative Part No	HB1241
Repair Kit	EKKB.54.3

12.02.1350	
	
Alternative Part No	HB1350
Repair Kit	EKKB.54.3

HAND CONTROL VALVES



EBS MAGNETI MARELLI HAND VALVES

EBS Part No.	Image	Alternative Part No.	Repair Kit
---	1	DPM21A	---
12.07.1019	1	DPM21AK/ K038802N00	---
12.07.1013	1	DPM22AK	---
12.07.1027	1	DPM23AK K038804N00	---
12.07.1018	1	DPM24AK/ K038805N00	---
12.07.1000	2	DPM28A	---
12.07.1001	2	DPM29A	---
---	3	DPM43A	EKMM.53
---	4	DPM60A	---
---	4	DPM60AA	---
---	4	DPM60EY	---
12.07.1028	4	DPM61EY	---
12.07.1020	4	DPM63AX	---
12.07.1015	5	DPM64A	---
12.07.1016	5	DPM65A	---
12.07.1012	5	DPM66A	---
12.07.10001	5	DPM66ELK/K162974N50	---
12.07.1014	5	DPM67AK K038809N00	---
---	6	DPM80A	---
---	6	DPM80AX	---
---	6	DPM80B	---
---	6	DPM80BY	---
---	7	DPM84AX	---
---	7	DPM84C	---
---	7	DPM84CY	---
---	7	DPM85AX	---
12.07.1011	8	DPM90A	EKMM.55.1 or SEKMM.55.1
---	8	DPM90AA	EKMM.55.1 or SEKMM.55.1

EBS Part No.	Image	Alternative Part No.	Repair Kit
12.07.1002	8	DPM90B	EKMM.55.1 or SEKMM.55.1
12.07.1003	8	DPM90CK	EKMM.55.1 or SEKMM.55.1
---	8	DPM90D	EKMM.55.1 or SEKMM.55.1
12.07.1004	8	DPM90DA	EKMM.55.1 or SEKMM.55.1
12.07.1023	8	DPM90DDX	EKMM.55.1 or SEKMM.55.1
12.07.1024	8	DPM90DE	EKMM.55.1 or SEKMM.55.1
12.07.1025	8	DPM90DEY	EKMM.55.1 or SEKMM.55.1
---	8	DPM90EY	EKMM.55.1 or SEKMM.55.1
12.07.1021	9	DPM91A	EKMM.55.1 or SEKMM.55.1
12.07.1006	10	DPM92AB	EKMM.55.1 or SEKMM.55.1
12.07.1005	8	DPM92A	EKMM.55.1 or SEKMM.55.1
---	8	DPM92B	EKMM.55.1 or SEKMM.55.1
12.07.1022	8	DPM92BK K153293N50	EKMM.55.1 or SEKMM.55.1
12.07.1007	8	DPM92D	EKMM.55.1 or SEKMM.55.1
12.07.1030	11	DPM92DE/ K010079	---
---	11	DPM93D	EKMM.55. or EKMM.55.3
12.07.1008	12	DPM94AAX	EKMM.55. or EKMM.55.3
12.07.1017	12	DPM94EY	---
12.07.1009	12	DPM95AAX	EKMM.55. or EKMM.55.3
---	13	DPM96AAX	EKMM.55. or EKMM.55.3
---	13	DPM96EY	EKMM.55. or EKMM.55.3
12.07.1010	14	DPM98A	EKMM.55.2
---	14	DPM98B	EKMM.55.2



EBS WABCO HAND VALVES

N723539ICV	
	
Alternative Part No	7235390008
Repair Kit	EKWA.54.ICV

12.01.1100	
	
Alternative Part No	9617011000
Repair Kit	EKWA.52

12.01.1105	
	
Alternative Part No	9617011050
Repair Kit	EKWA.52

	
Alternative Part No	9617011060
Repair Kit	EKWA.52

	
Alternative Part No	9617011100
Repair Kit	EKWA.52

12.01.2001	
	
Alternative Part No	9617020010
Repair Kit	EKWA.53

12.01.2004	
	
Alternative Part No	9617020040
Repair Kit	EKWA.53

12.01.2008	
	
Alternative Part No	9617020080
Repair Kit	EKWA.53

	
Alternative Part No	9617020140
Repair Kit	EKWA.53

	
Alternative Part No	9617020310
Repair Kit	EKWA.53

12.01.3001	
	
Alternative Part No	9617030010
Repair Kit	EKWA.52.C

12.01.4000	
	
Alternative Part No	9617210000
Repair Kit	EKWA.54.A

12.01.4004	
	
Alternative Part No	9617210040
Repair Kit	EKWA.54.A

12.01.4010	
	
Alternative Part No	9617210100
Repair Kit	EKWA.54.A

12.01.4011	
	
Alternative Part No	9617210110
Repair Kit	EKWA.54.A

12.01.4017	
	
Alternative Part No	9617210170
Repair Kit	EKWA.54.A

	
Alternative Part No	9617210190
Repair Kit	EKWA.54.A

12.01.4020	
	
Alternative Part No	9617210200
Repair Kit	EKWA.54.A

12.01.4033	
	
Alternative Part No	9617210330
Repair Kit	EKWA.54.A

12.01.4040	
	
Alternative Part No	9617210400
Repair Kit	EKWA.54.A

HAND CONTROL VALVES

EBS WABCO HAND VALVES

12.01.4044		12.01.4054		12.01.5150		12.01.5151	
Alternative Part No	9617210440	Alternative Part No	9617210540	Alternative Part No	9617221500	Alternative Part No	9617221510
Repair Kit	EKWA.54.A	Repair Kit	EKWA.54.A	Repair Kit	EKWA.54.1 or EKWA.54.1B	Repair Kit	EKWA.54.1 or EKWA.54.1B
12.01.5156		---		12.01.5160		12.01.5170	
Alternative Part No	9617221560	Alternative Part No	9617221580	Alternative Part No	9617221600	Alternative Part No	9617221700
Repair Kit	EKWA.54.1 or EKWA.54.1B	Repair Kit	EKWA.54.1 or EKWA.54.1B	Repair Kit	EKWA.54.1 or EKWA.54.1B	Repair Kit	EKWA.54.1 or EKWA.54.1B
12.01.5172		---		---		---	
Alternative Part No	9617221720	Alternative Part No	9617221730	Alternative Part No	9617221790	Alternative Part No	9617221800
Repair Kit	EKWA.54.1 or EKWA.54.1B	Repair Kit	EKWA.54.1 or EKWA.54.1B	Repair Kit	EKWA.54.1 or EKWA.54.1B	Repair Kit	EKWA.54.1 or EKWA.54.1B
---		12.01.5212		12.01.5232		---	
Alternative Part No	9617222100	Alternative Part No	9617222120	Alternative Part No	9617222320	Alternative Part No	9617222500
Repair Kit	EKWA.54.1 or EKWA.54.1B	Repair Kit	EKWA.54.2	Repair Kit	EKWA.54.2	Repair Kit	EKWA.54.1 or EKWA.54.1B
---		12.01.5250		12.01.5251		12.01.5252	
Alternative Part No	9617222140	Alternative Part No	9617222500	Alternative Part No	9617222510	Alternative Part No	9617222520
Repair Kit	EKWA.54.3	Repair Kit	EKWA.54.1	Repair Kit	EKWA.54.3	Repair Kit	KWA.54.2

EBS WABCO HAND VALVES

12.01.5253	
	
Alternative Part No	9617222530
Repair Kit	EKWA.54.3

	
Alternative Part No	9617222540
Repair Kit	EKWA.54.2

12.01.5258	
	
Alternative Part No	9617222580
Repair Kit	EKWA.54.3

12.01.5260	
	
Alternative Part No	9617222600
Repair Kit	EKWA.54.3

12.01.5262	
	
Alternative Part No	9617222620
Repair Kit	EKWA.54.3

12.01.5264	
	
Alternative Part No	9617222640
Repair Kit	EKWA.54.3

12.01.5265	
	
Alternative Part No	9617222650
Repair Kit	EKWA.54.3

12.01.5266	
	
Alternative Part No	9617222660
Repair Kit	EKWA.54.2

	
Alternative Part No	9617222670
Repair Kit	EKWA.54.2

12.01.5269	
	
Alternative Part No	9617222690
Repair Kit	EKWA.54.3

	
Alternative Part No	9617222720
Repair Kit	EKWA.54.2

12.01.5275	
	
Alternative Part No	9617222750
Repair Kit	EKWA.54.3

12.01.5284	
	
Alternative Part No	9617222840
Repair Kit	EKWA.54.2

	
Alternative Part No	9617222860
Repair Kit	EKWA.54.2

	
Alternative Part No	9617222880
Repair Kit	EKWA.54.2

	
Alternative Part No	9617222920
Repair Kit	EKWA.54.1 or EKWA.54.1B

12.01.5302	
	
Alternative Part No	9617223020
Repair Kit	EKWA.54.2

12.01.5305	
	
Alternative Part No	9617223050
Repair Kit	EKWA.54.2

12.01.5306	
	
Alternative Part No	9617223060
Repair Kit	EKWA.54.3

	
Alternative Part No	9617223120
Repair Kit	EKWA.54.3

HAND CONTROL VALVES

EBS WABCO HAND VALVES

---		12.01.5314		12.01.5324		12.01.5325	
							
Alternative Part No	9617223130	Alternative Part No	9617223140	Alternative Part No	9617223240	Alternative Part No	9617223250
Repair Kit	EKWA.54.3	Repair Kit	EKWA.54.3	Repair Kit	EKWA.54.2	Repair Kit	EKWA.54.2
---		---		12.01.6001		---	
							
Alternative Part No	9617223260	Alternative Part No	9617226890	Alternative Part No	9617230010	Alternative Part No	9617230020
Repair Kit	EKWA.54.2	Repair Kit	EKWA.54.3	Repair Kit	EKWA.55 or EKWA.55.1	Repair Kit	EKWA.55 or EKWA.55.1
12.01.6003		12.01.6004		12.01.6005		12.01.6007	
							
Alternative Part No	9617230030	Alternative Part No	9617230040	Alternative Part No	9617230050	Alternative Part No	9617230070
Repair Kit	EKWA.55 or EKWA.55.1	Repair Kit	EKWA.55 or EKWA.55.1	Repair Kit	EKWA.55 or EKWA.55.1	Repair Kit	EKWA.55 or EKWA.55.1
12.01.6008		12.01.6010		12.01.6011		---	
							
Alternative Part No	9617230410	Alternative Part No	9617230100	Alternative Part No	9617230110	Alternative Part No	9617230120
Repair Kit	---	Repair Kit	EKWA.55 or EKWA.55.1	Repair Kit	EKWA.55 or EKWA.55.1	Repair Kit	EKWA.55 or EKWA.55.1
12.01.6015		12.01.6016		12.01.6017		12.01.6019	
							
Alternative Part No	9617230150	Alternative Part No	9617230160	Alternative Part No	9617230170	Alternative Part No	9617230190
Repair Kit	EKWA.55 or EKWA.55.1	Repair Kit	EKWA.55 or EKWA.55.1	Repair Kit	EKWA.55 or EKWA.55.1	Repair Kit	EKWA.55 or EKWA.55.1

EBS WABCO HAND VALVES

12.01.6021	
	
Alternative Part No	9617230210
Repair Kit	EKWA.55 or EKWA.55.1

12.01.6022	
	
Alternative Part No	9617230220
Repair Kit	EKWA.55 or EKWA.55.1

12.01.6023	
	
Alternative Part No	9617230230
Repair Kit	EKWA.55 or EKWA.55.1

12.01.6025	
	
Alternative Part No	9617230250
Repair Kit	EKWA.55 or EKWA.55.1

12.01.6026	
	
Alternative Part No	9617230260
Repair Kit	EKWA.55 or EKWA.55.1

12.01.6027	
	
Alternative Part No	9617230270
Repair Kit	EKWA.55 or EKWA.55.1

12.01.6028	
	
Alternative Part No	9617230280
Repair Kit	EKWA.55 or EKWA.55.1

12.07.1007	
	
Alternative Part No	9617230300
Repair Kit	EKWA.55 or EKWA.55.1

12.01.6031	
	
Alternative Part No	9617230310
Repair Kit	EKWA.55 or EKWA.55.1

12.01.10001	
	
Alternative Part No	9617230360
Repair Kit	EKWA.55 or EKWA.55.1

	
Alternative Part No	9617230380
Repair Kit	EKWA.55 or EKWA.55.1

12.01.6039	
	
Alternative Part No	9617230390
Repair Kit	EKWA.55 or EKWA.55.1

12.01.6040	
	
Alternative Part No	9617230400
Repair Kit	EKWA.55 or EKWA.55.1

12.01.6041	
	
Alternative Part No	9617230410
Repair Kit	EKWA.55 or EKWA.55.1

12.01.6100	
	
Alternative Part No	9617231000
Repair Kit	EKWA.55 or EKWA.55.1

12.01.6102	
	
Alternative Part No	9617231020
Repair Kit	EKWA.55 or EKWA.55.1

12.01.6104	
	
Alternative Part No	9617231040
Repair Kit	EKWA.55 or EKWA.55.1

12.01.6107	
	
Alternative Part No	9617231070
Repair Kit	EKWA.55 or EKWA.55.1

12.01.6108	
	
Alternative Part No	9617231080
Repair Kit	EKWA.55 or EKWA.55.1

12.01.6109	
	
Alternative Part No	9617231090
Repair Kit	EKWA.55 or EKWA.55.1

HAND CONTROL VALVES

EBS WABCO HAND VALVES

12.01.6110		Alternative Part No	9617231100	Alternative Part No	9617231110	Alternative Part No	9617231120	Alternative Part No	9617231150
		Repair Kit	EKWA.55 or EKWA.55.1	Repair Kit	EKWA.55 or EKWA.55.1	Repair Kit	EKWA.55 or EKWA.55.1	Repair Kit	EKWA.55 or EKWA.55.1
12.01.6116		Alternative Part No	9617231160	---	9617231170	12.01.6118		Alternative Part No	9617231220
		Repair Kit	EKWA.55 or EKWA.55.1	Repair Kit	EKWA.55 or EKWA.55.1			Repair Kit	EKWA.55 or EKWA.55.1
12.01.6123		Alternative Part No	9617231230	---	9617231240	12.01.6125		Alternative Part No	9617231260
		Repair Kit	EKWA.55 or EKWA.55.1	Repair Kit	EKWA.55 or EKWA.55.1			Repair Kit	EKWA.55 or EKWA.55.1
12.01.6127		Alternative Part No	9617231270	---	9617231320	12.01.6134		Alternative Part No	9617231390
		Repair Kit	EKWA.55 or EKWA.55.1	Repair Kit	EKWA.55 or EKWA.55.1			Repair Kit	EKWA.55 or EKWA.55.1
12.01.6140		Alternative Part No	9617231400	12.01.6200		12.01.6201		Alternative Part No	9617232030
		Repair Kit	EKWA.55 or EKWA.55.1	Repair Kit	EKWA.55 or EKWA.55.1			Repair Kit	EKWA.55 or EKWA.55.1

EBS WABCO HAND VALVES

	
Alternative Part No	9617232040
Repair Kit	EKWA.55 or EKWA.55.1

	
Alternative Part No	9617232050
Repair Kit	EKWA.55 or EKWA.55.1

	
Alternative Part No	9617232070
Repair Kit	EKWA.55 or EKWA.55.1

12.01.6208	
	
Alternative Part No	9617232080
Repair Kit	EKWA.55 or EKWA.55.1

12.01.6212	
	
Alternative Part No	9617232120
Repair Kit	EKWA.55 or EKWA.55.1

12.01.6213	
	
Alternative Part No	9617232130
Repair Kit	EKWA.55 or EKWA.55.1

12.01.6215	
	
Alternative Part No	9617232150
Repair Kit	EKWA.55 or EKWA.55.1

12.01.6217	
	
Alternative Part No	9617232170
Repair Kit	EKWA.55 or EKWA.55.1

12.01.6403	
	
Alternative Part No	9617234030
Repair Kit	EKWA.55 or EKWA.55.1

	
Alternative Part No	9617234050
Repair Kit	EKWA.55 or EKWA.55.1

	
Alternative Part No	9617234110
Repair Kit	EKWA.55 or EKWA.55.1

12.01.6418	
	
Alternative Part No	9617234180
Repair Kit	EKWA.55 or EKWA.55.1

12.01.6420	
	
Alternative Part No	9617234200
Repair Kit	EKWA.55 or EKWA.55.1

12.01.6421	
	
Alternative Part No	9617234210
Repair Kit	EKWA.55 or EKWA.55.1

	
Alternative Part No	9617234240
Repair Kit	EKWA.55 or EKWA.55.1

	
Alternative Part No	9617234200
Repair Kit	EKWA.55 or EKWA.55.1

HAND CONTROL VALVES

EBS SCANIA "R" SERIES WABCO HAND VALVES

12.01.7224		12.01.7225		12.01.7208		12.01.7209	
Alternative Part No	9617242240	Alternative Part No	9617242250	Alternative Part No	9617242000 9617242080	Alternative Part No	9617242090 9617242110
Repair Kit	EKWA.55.10	Repair Kit	EKWA.55.10	Repair Kit	EKWA.55.9	Repair Kit	EKWA.55.9

EBS REMANUFACTURED HAND BRAKE VALVES

R12.06.1005	
Alternative Part No	KY932/8
Repair Kit	---

EBS BOSCH HAND VALVES REPAIR KITS

<p>EKBO.5.7</p>	<p>EKBO.54.1</p>	<p>EKBO.54.2</p>	<p>EKKB.2</p>
<p>EKBO.54.3</p>			

EBS CLAYTON DEWANDRE HAND VALVES REPAIR KITS

<p>EKCD.54</p>

EBS PAUL DAHL HAND VALVES REPAIR KITS

<p>EKPD.52</p>

EBS KNORR BREMSE HAND VALVES REPAIR KITS

<p>EKKB.54.1</p>	<p>EKKB.54.3</p>
------------------	------------------

EBS MAGNETI MARELLI HAND VALVES REPAIR KITS

<p>EKMM.53</p> 	<p>EKMM.54</p> <p>Please note this Handle Kit covers all the DPM95 range</p> 	<p>EKMM.54.5.A</p> <p>To suit DPM21, DPM24, DPM67</p> 	<p>EKMM.55</p> 
<p>EKMM.55.1</p> 	<p>EKMM.55.2</p> 	<p>EKMM.55.3</p> 	<p>EKMM.56</p> 
<p>SEKMM.55.1</p> 			

EBS WABCO HAND VALVES

<p>EKWA.52</p> 	<p>EKWA.52.C</p> 	<p>EKWA.53</p> 	<p>EKWA.54.ICV</p> 
<p>EKWA.54.1</p> 	<p>EKWA.54.1B</p> 	<p>EKWA.54.2</p> 	<p>EKWA.54.3</p> 

HAND CONTROL VALVES

EBS WABCO HAND VALVES

EKWA.54.A



EKWA.55



EKWA.55.1



EKWA.55.9



EKWA.55.10



SEKWA.55



SEKWA.55.1



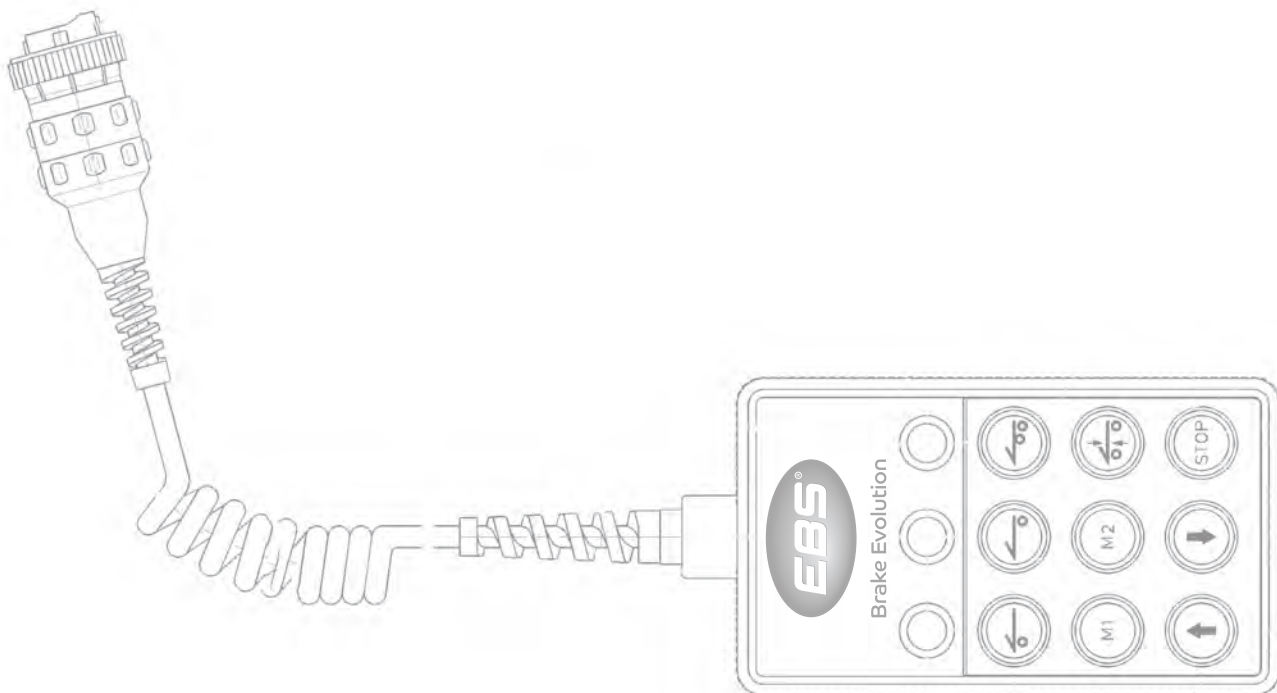
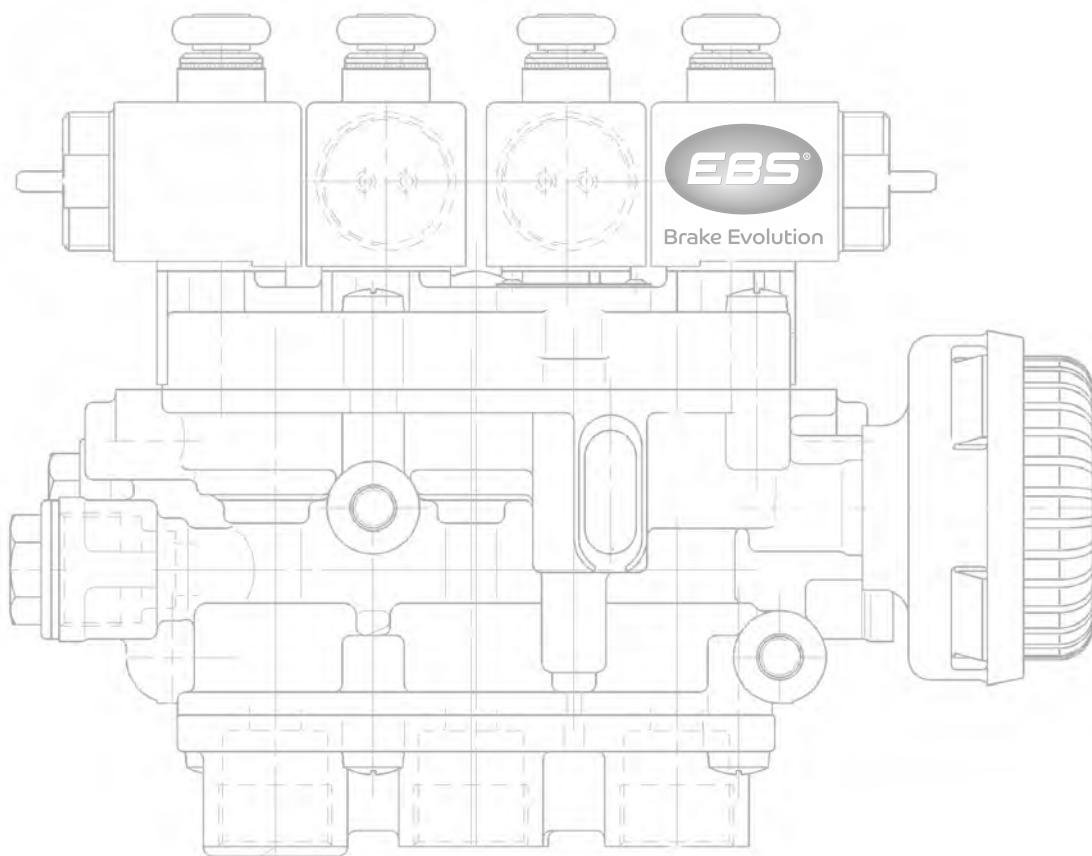

For ECAS Height Sensors please see section 14

EBS ECAS VALVES - BOSCH

---		13.04.1003		13.04.1000		13.04.1002	
							
Alternative Part No	0501100017000	Alternative Part No	0501100018000	Alternative Part No	0501100029000	Alternative Part No	0501100030000
Repair Kits	EKBO.31.1 4 PIN APPLICATION and EKBO.31.1A	Repair Kits	EKBO.31.1 4 PIN APPLICATION and EKBO.31.1A	Repair Kits	EKBO.31.1 4 PIN APPLICATION and EKBO.31.1A	Repair Kits	---
13.04.1001		13.04.1005		13.04.1007		13.04.1006	
							
Alternative Part No	0501100031000	Alternative Part No	0501100041100	Alternative Part No	0501100038100	Alternative Part No	0501100052000
Repair Kits	EKBO.31.2 3 PIN APPLICATION and EKBO.31.1A	Repair Kits	EKBO.31.2 4 PIN APPLICATION and EKBO.31.1A	Repair Kits	---	Repair Kits	EKBO.31.1 4 PIN APPLICATION and EKBO.31.1A
13.04.1008							
							
Alternative Part No	0501100055000						
Repair Kits	EKBO.31.1 4 PIN APPLICATION and EKBO.31.1A						

EBS ECAS VALVES - KNORR BREMSE

---		13.02.1000		13.02.1001		13.02.1002	
							
Alternative Part No	K019819	Alternative Part No	K019819N50	Alternative Part No	K019820	Alternative Part No	K019821
Repair Kit	EKKB.31.1	Repair Kit	---	Repair Kit	EKKB.31.2 EKKB.31.2.S	Repair Kit	EKKB.31.2 EKKB.31.2.S

EBS ECAS VALVES - WABCO

13.01.3000	
	
Alternative Part No	4728800000
Repair Kits	EKWA.31.9 and EKWA.31.S3

13.01.3001	
	
Alternative Part No	4728800010
Repair Kits	EKWA.31.9 and EKWA.31.S3

13.01.3004	
	
Alternative Part No	4728800040
Repair Kits	EKWA.31.9 and EKWA.31.S3

13.01.3020	
	
Alternative Part No	4728800200
Repair Kits	EKWA.31.9 and EKWA.31.S1A

13.01.3021	
	
Alternative Part No	4728800210
Repair Kits	EKWA.31.9 EKWA.31.S1A

13.01.3024	
	
Alternative Part No	4728800240
Repair Kits	EKWA.31.9 EKWA.31.S1A

13.01.3030	
	
Alternative Part No	4728800300
Repair Kits	EKWA.31.9 and EKWA.31.S2

13.01.3032	
	
Alternative Part No	4728800320
Repair Kits	EKWA.31.9 and EKWA.31.S2

13.01.3050	
	
Alternative Part No	4728800500
Repair Kits	EKWA.31.9, EKWA.31.S3 and EKWA.31.S1A

13.01.3061	
	
Alternative Part No	4728800610
Repair Kits	EKWA.31.9, EKWA.31.S3 and EKWA.31.S1A

13.01.3064	
	
Alternative Part No	4728800640
Repair Kits	EKWA.31.9, EKWA.31.S3 and EKWA.31.S1A

13.01.3065	
	
Alternative Part No	4728800650
Repair Kits	---

13.01.3100	
	
Alternative Part No	4728801000
Repair Kits	EKWA.31.9 (x2 of these kits may be required)
EKWA.31.S2, and EKWA.31.S3 or EKWA.31.S5	

13.01.3103	
	
Alternative Part No	4728801030
Repair Kits	EKWA.31.S2, and EKWA.31.S3 or EKWA.31.S5

13.01.3104	
	
Alternative Part No	4728801040
Repair Kits	EKWA.31.S2, and EKWA.31.S3 or EKWA.31.S5

13.01.4022	
	
Alternative Part No	4728900220
Repair Kits	----

ECAS & ILAS VALVES











EBS ECAS VALVES - WABCO

13.01.4003		13.01.1001		13.01.1002		---	
Alternative Part No	4728900500	Alternative Part No	4729000010	Alternative Part No	4729000020	Alternative Part No	4729000080
Repair Kits	EKWA.10008	Repair Kits	EKWA.31.3 and EKWA.31.S1 (x3 of these kits may be required)	Repair Kits	EKWA.31.3 and EKWA.31.S1 (x3 of these kits may be required)	Repair Kits	EKWA.31.3 and EKWA.31.S1 (x3 of these kits may be required)
		13.01.1009		13.01.1012		13.01.1021	
		4729000090		4729000120			
Repair Kits EKWA.31.3 and EKWA.31.S1 (x3 of these kits may be required)		13.01.1013		13.01.1014		Alternative Part No	4729000210
		4729000130		4729000140		Repair Kits	EKWA.31.3 and EKWA.31.S1
13.01.1022		13.01.1032		13.01.1033		13.01.1050	
Alternative Part No	4729000220	Alternative Part No	4729000320	Alternative Part No	4729000330	Alternative Part No	4729000500
Repair Kits	EKWA.31.3 and EKWA.31.S1	Repair Kits	EKWA.31.3 and EKWA.31.S1 (x2 of these kits may be required)	Repair Kits	EKWA.31.3 and EKWA.31.S1 (x2 of these kits may be required)	Repair Kits	EKWA.31.3 (x2 of these kits will be required) and EKWA.31.S1 (x6 of these kits may be required)
13.01.1052		13.01.1053		13.01.1054		13.01.1055	
Alternative Part No	4729000520	Alternative Part No	4729000530	Alternative Part No	4729000540	Alternative Part No	4729000550
Repair Kits	EKWA.31.3 (x2 of these kits will be required) and EKWA.31.S1 (x4 of these kits may be required)	Repair Kits	EKWA.31.3 and EKWA.31.S3	Repair Kits	EKWA.31.3 and EKWA.31.S1A	Repair Kits	EKWA.31.3 and EKWA.31.S2

EBS ECAS VALVES - WABCO

13.01.1056		13.01.1057		13.01.1058		13.01.1059	
							
Alternative Part No	4729000560	Alternative Part No	4729000570	Alternative Part No	4729000580	Alternative Part No	4729000590
Repair Kits	EKWA.31.3 (x2 of these kits will be required), EKWA.31.S1A, EKWA.31.S2, EKWA.31.S1S & EKWA.31.S3	Repair Kits	EKWA.31.3 (x2 of these kits will be required) and EKWA.31.S1A and EKWA.31.S3	Repair Kits	EKWA.31.3 and EKWA.31.S1A	Repair Kits	EKWA.31.3 (x2 of these kits will be required) and EKWA.31.S1 (x6 of these kits may be required)
13.01.1060		13.01.1061		13.01.1062		13.01.1063	
							
Alternative Part No	4729000600	Alternative Part No	4729000610	Alternative Part No	4729000620	Alternative Part No	4729000630
Repair Kits	EKWA.31.3 and EKWA.31.S3	Repair Kits	EKWA.31.3 and EKWA.31.S2	Repair Kits	EKWA.31.3 and EKWA.31.S3	Repair Kits	EKWA.31.3 and EKWA.31.S3
13.01.1064		13.01.1065		13.01.1067		13.01.1073	
							
Alternative Part No	4729000640	Alternative Part No	4729000650	Alternative Part No	4729000670	Alternative Part No	4729000730
Repair Kits	EKWA.31.3 and EKWA.31.S1C	Repair Kits	EKWA.31.3 and EKWA.31.S2	Repair Kits	EKWA.31.3 (x2 of these kits will be required) and EKWA.31.S1A and EKWA.31.S3	Repair Kits	EKWA.31.3 and EKWA.31.S2
13.01.1074		13.01.1101		13.01.1102		---	
							
Alternative Part No	4729000740	Alternative Part No	4729001010	Alternative Part No	4729001020	Alternative Part No	4729001050
Repair Kits	EKWA.31.3 and EKWA.31.S1C	Repair Kits	EKWA.31.3 (x2 of these kits will be required) and EKWA.31.S1 (x5 of these kits may be required)	Repair Kits	EKWA.31.3 (x2 of these kits will be required) and EKWA.31.S1 (x5 of these kits may be required)	Repair Kits	EKWA.31.3 (x2 of these kits will be required) or EKWA.31.S1 (x5 of these kits may be required)

EBS ECAS VALVES - WABCO

13.01.1110		13.01.1112		13.01.1113		13.01.1114	
							
Alternative Part No	4729001100	Alternative Part No	4729001120	Alternative Part No	4729001130	Alternative Part No	4729001140
Repair Kits	EKWA.31.3 (x2 of these kits will be required) and EKWA.31.S2, EKWA.31.S3 or EKWA.31.S5	Repair Kits	EKWA.31.3 (x2 of these kits will be required) and EKWA.31.S2, EKWA.31.S3 or EKWA.31.S5	Repair Kits	EKWA.31.3 (x2 of these kits will be required) and EKWA.31.S2 (x2 of these kits may be required)	Repair Kits	EKWA.31.3 (x2 of these kits will be required) and EKWA.31.S3 (x2 of these kits may be required)
13.01.2107		---		13.01.2111		13.01.2114	
							
Alternative Part No	4729051070	Alternative Part No	4729051080	Alternative Part No	4729051110	Alternative Part No	4729051140
Repair Kits	EKWA.31.6	Repair Kits	EKWA.31.6	Repair Kits	EKWA.31.6, EKWA.31.S2, EKWA.31.S3 or EKWA.31.S5	Repair Kits	EKWA.31.6, EKWA.31.S2, EKWA.31.S3 or EKWA.31.S5
13.01.2116		13.01.2118					
							
Alternative Part No	4729051160	Alternative Part No	4729051180				
Repair Kits	EKWA.31.6, EKWA.31.S2, EKWA.31.S3 or EKWA.31.S5	Repair Kits	EKWA.31.6, EKWA.31.S2, EKWA.31.S3 or EKWA.31.S5				

EBS HALDEX ILAS VALVES

		Alt.	352028011	352028012 4729000090	352028014	352032030	352032035	352047030	352047032
			---	---	---	---	---	---	---
Repair Kits	027049009	Alt.	352047035	352047045	352047100	352047200	352049100	352054E35	352054X53

	
Alternative Part No	352051100
Repair Kits	---

	
Alternative Part No	352051200
Repair Kits	---

	
Alternative Part No	360009141
Repair Kits	---

	
Alternative Part No	360009241
Repair Kits	---

	
Alternative Part No	360009341
Repair Kits	---

	
Alternative Part No	3520611011
Repair Kits	---

	
Alternative Part No	352061111
Repair Kits	---

	
Alternative Part No	352062101
Repair Kits	---

	
Alternative Part No	352062111
Repair Kits	---

13.03.1000	
	
Alternative Part No	352070111 352080001
Repair Kits	---

ECAS & ILAS VALVES

ECAS REMOTE CONTROL UNITS

Universal Alternative	4460561150	Universal Alternative	4460561300	Universal Alternative	4460561200	Universal Alternative	4460561390
Replaces	4460560150	Replaces	4460560300	Replaces	4460560190 4460560200 4460561190	Replaces	4460561380
Application	DAF	Application	DAF Controls Front & Rear Axles - Not Lift Axle.	Application	IVECO Controls Front & Rear Axles	Application	MAN Controls Front & Rear Axles - Not Lift Axle

Universal Alternative	4460561130	Universal Alternative	4460563340	Universal Alternative	4460561020	Universal Alternative	4460563340
Replaces	4460560120 4460560130	Replaces	4460560330 4460560340 4460561340 4460561330 4460563330	Replaces	4460560020 4460560050 4460560090	Replaces	4460560260 4460560310 4460561260 4460561310
Application	MERCEDES	Application	MERCEDES	Application	RENAULT	Application	SCANIA Controls Front & Rear Axles - Not Lift Axle

13.01.6117		
Universal Alternative	4460561170	
Replaces	4460560000 4460560110 4460560160 4460560180 4460560240 4460560280 4460560320 4460561000 4460561240 4460561280	4460561320 4460561360 4460561400 4460560070 4460560140 4460560170 4460560270 4460560290 4460560350 4460561160
Application	UNIVERSAL Controls Full Air Suspension, Lifting Axle Including Memory Function	

MOUNTING BRACKET FOR ECAS REMOTE CONTROL UNITS	
Alternative	4460560104

EBS ECAS VALVES KITS - BOSCH

EBS ILAS VALVES KNOB - HALDEX

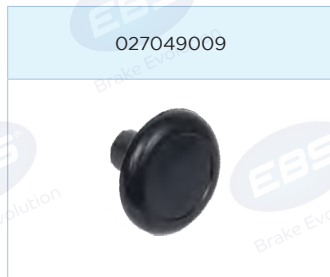

EBS ECAS VALVES KITS - KNORR BREMSE

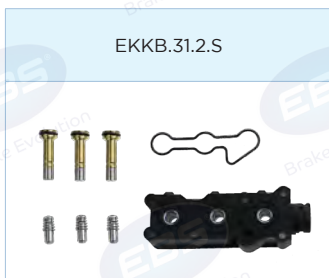

EBS ECAS VALVES - WABCO



ECAS & ILAS VALVES

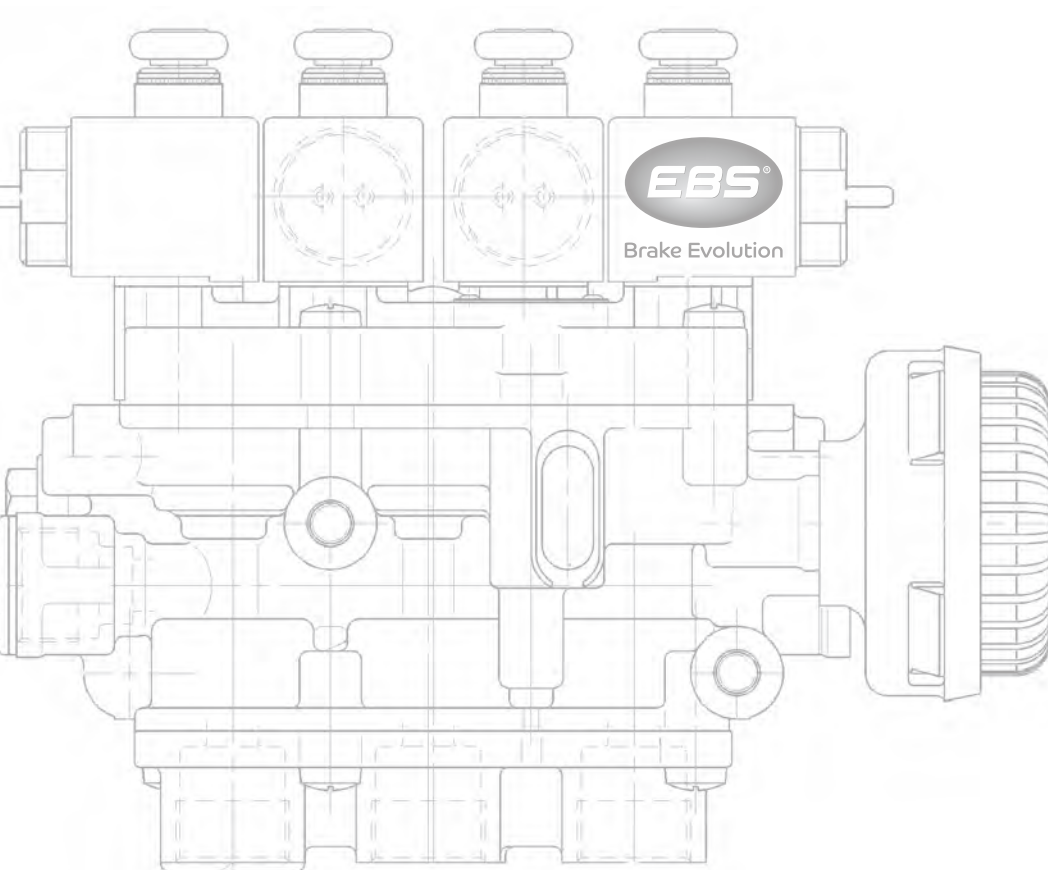

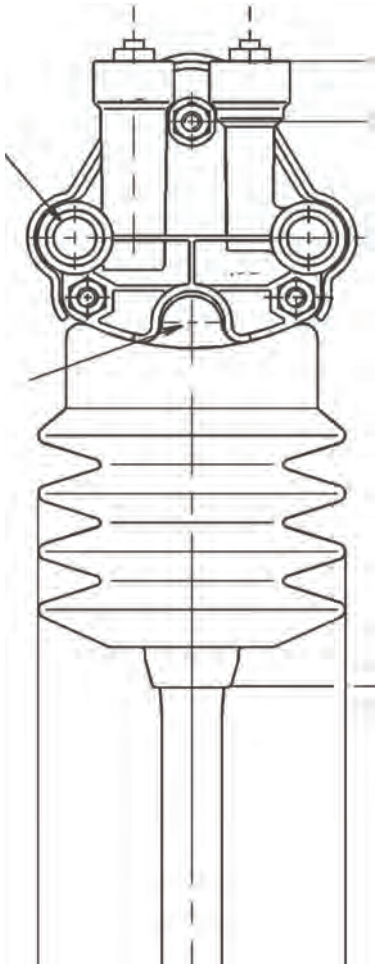
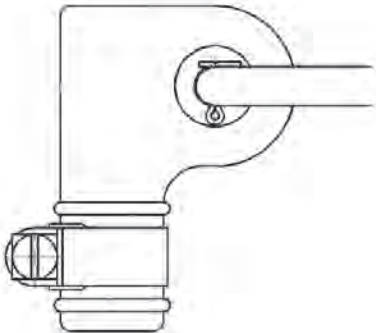
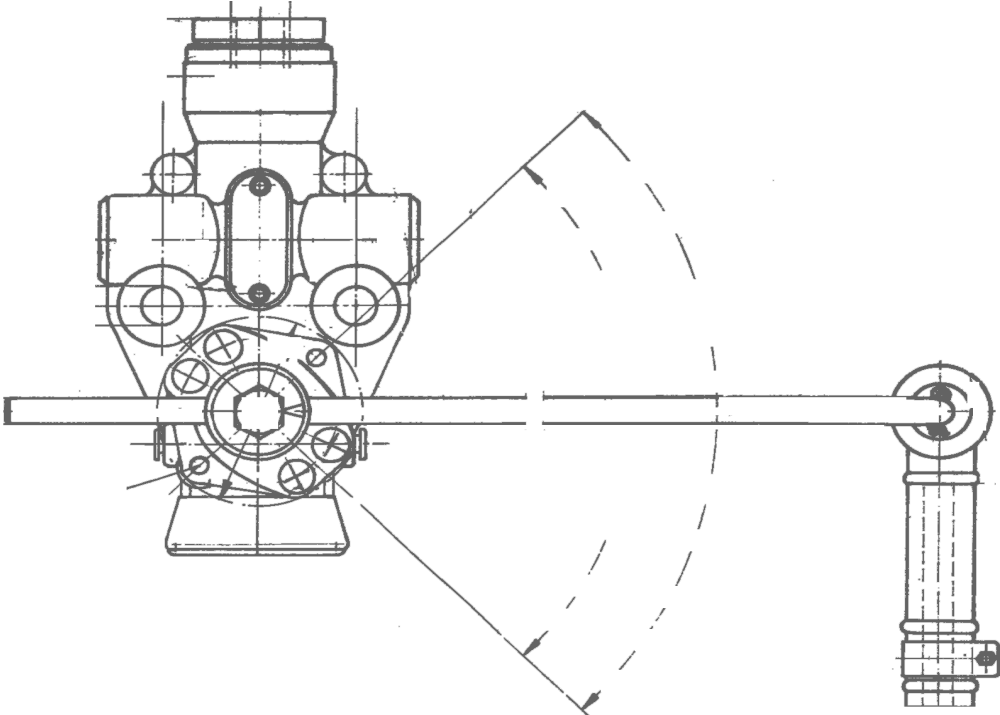

LOAD LEVELLING VALVES

EBS CAB LEVELLING VALVES - HALDEX

14.03.1004	
	
Alternative Part No	90554663
Repair Kits	---





EBS CAB LEVELLING VALVES - KNORR BREMSE

---		---		---		14.02.1496	
							
Alternative Part No	SV1490	Alternative Part No	SV1491	Alternative Part No	SV1493	Alternative Part No	SV1496
Repair Kits	---	Repair Kits	---	Repair Kits	---	Repair Kits	---



EBS CAB LEVELLING VALVES - VOLVO

14.30.1000		14.30.1001		14.30.1014	
					
Alternative Part No	2051451 20583428 21253672 21585711 21643575	Alternative Part No	21585711 22194741 21643575	Alternative Part No	1620067
Repair Kits	---	Repair Kits	---	Repair Kits	---

EBS CAB LEVELLING VALVES - WABCO

14.01.4001		14.01.4002		14.01.4003		14.01.4004	
							
Alternative Part No	4640070010	Alternative Part No	4640070020	Alternative Part No	4640070030	Alternative Part No	4640070040
Repair Kits	EKWA.26.6 or SEKWA.26.6	Repair Kits	EKWA.26.7 or SEKWA.26.6	Repair Kits	EKWA.26.7 or SEKWA.26.6	Repair Kits	EKWA.26.7 or SEKWA.26.6

14.01.4006		14.01.4007		14.01.4008		14.01.4009	
							
Alternative Part No	4640070060	Alternative Part No	4640070070	Alternative Part No	4640070080	Alternative Part No	4640070090
Repair Kits	EKWA.26.7 or SEKWA.26.6	Repair Kits	EKWA.26.7 or SEKWA.26.6	Repair Kits	EKWA.26.7 or SEKWA.26.6	Repair Kits	EKWA.26.6 or SEKWA.26.6

14.01.4010		14.01.4011		14.01.4013		14.01.4014	
							
Alternative Part No	4640070100	Alternative Part No	4640070110	Alternative Part No	4640070130	Alternative Part No	4640070140
Repair Kits	EKWA.26.8 or SEKWA.26.6	Repair Kits	EKWA.26.7 or SEKWA.26.6	Repair Kits	EKWA.26.8 or SEKWA.26.6	Repair Kits	EKWA.26.8 or SEKWA.26.6

14.01.4015		14.01.4016		14.01.4017		14.01.4018	
							
Alternative Part No	4640070150	Alternative Part No	4640070160	Alternative Part No	4640070170	Alternative Part No	4640070180
Repair Kits	EKWA.26.7 or SEKWA.26.6	Repair Kits	EKWA.26.7 or SEKWA.26.6	Repair Kits	EKWA.26.7 or SEKWA.26.6	Repair Kits	EKWA.26.8 or SEKWA.26.6

LOAD LEVELLING VALVES

EBS CAB LEVELLING VALVES - WABCO

14.01.4019		14.01.4020		14.01.4021		14.01.4022	
							
Alternative Part No	4640070190	Alternative Part No	4640070200	Alternative Part No	4640070210	Alternative Part No	4640070220
Repair Kits	EKWA.26.7 or SEKWA.26.6	Repair Kits	EKWA.26.7 or SEKWA.26.6	Repair Kits	EKWA.26.7 or SEKWA.26.6	Repair Kits	EKWA.26.8 or SEKWA.26.6
14.01.4023		14.01.4025		14.01.10000			
							
Alternative Part No	4640070230	Alternative Part No	4640070250	Alternative Part No	4640078140		
Repair Kits	EKWA.26.7 or SEKWA.26.6	Repair Kits	EKWA.26.7 SEKWA.26.6	Repair Kits	---		

EBS LOAD LEVELLING VALVES - BOSCH

14.04.1000		14.04.1003		14.04.1004		14.04.1007	
							
Alternative Part No	0500004201000	Alternative Part No	0500005001000	Alternative Part No	0500005002000	Alternative Part No	0500005006000
Repair Kits	---	Repair Kits	EKBO.3, EKBO.3.1 or EKBO.3.3	Repair Kits	EKBO.3, EKBO.3.1 or EKBO.3.3	Repair Kits	EKBO.3, EKBO.3.2 or EKBO.3.3
14.04.1008		14.04.1009		14.04.1010		14.04.1001	
							
Alternative Part No	0500005007000	Alternative Part No	0500005011000	Alternative Part No	0500005012000	Alternative Part No	0500005017000
Repair Kits	EKBO.3, EKBO.3.2 or EKBO.3.3	Repair Kits	EKBO.3, EKBO.3.2 or EKBO.3.3	Repair Kits	EKBO.3, EKBO.3.2 or EKBO.3.3	Repair Kits	EKBO.3, EKBO.3.4 or EKBO.3.3

EBS LOAD LEVELLING VALVES - BOSCH

14.04.1005		14.04.1006		14.04.1011		14.04.1012	
							
Alternative Part No	0500005101000	Alternative Part No	0500005102000	Alternative Part No	0500005104000	Alternative Part No	0500005105000
Repair Kits	EKBO.3, EKBO.3.4 or EKBO.3.3	Repair Kits	EKBO.3, EKBO.3.4 or EKBO.3.3	Repair Kits	EKBO.3, EKBO.3.4 or EKBO.3.3	Repair Kits	EKBO.3, EKBO.3.4 or EKBO.3.3

EBS LOAD LEVELLING VALVES - BERTOCCO

---		14.02.1287	
			
Alternative Part No	M2290010	Alternative Part No	M2362000
Repair Kits	---	Repair Kits	---

EBS LOAD LEVELLING VALVES - DAHL (Paul Dahl)

---		14.08.1000	
			
Alternative Part No	M2290010	Alternative Part No	1111730000
Repair Kits	---	Repair Kits	---

EBS LOAD LEVELLING VALVES - DUNLOP TRELLEBORG

---		---		---		---	
							
Alternative Part No	PNP300340000	Alternative Part No	PNP300360000	Alternative Part No	PNP306250000	Alternative Part No	PNP308040100
Information	---	Information	---	Information	---	Information	---
Repair Kits	---	Repair Kits	---	Repair Kits	---	Repair Kits	---

---		---		---		---	
							
Alternative Part No	PNP308990200	Alternative Part No	PNP309100100	Alternative Part No	PNP3103202YY	Alternative Part No	PNP311600200
Information	---	Information	---	Information	---	Information	With Lift Ports: M12x1.5
Repair Kits	---	Repair Kits	---	Repair Kits	---	Repair Kits	---

LOAD LEVELLING VALVES

EBS LOAD LEVELLING VALVES - DUNLOP TRELLEBORG

Alternative Part No	PNP311600201	Alternative Part No	PNP311600203	Alternative Part No	PNP311600204
Information	Without Lift Ports: M12x1.5	Information	Without Lift Ports: M12x1.5	Information	C/W Height Limiting Function Without Lift Ports: M12x1.5
Repair Kits	---	Repair Kits	---	Repair Kits	---

EBS LOAD LEVELLING VALVES - HALDEX / NEWAY

14.03.1001 		14.03.1003 		--- 		14.03.1002 	
Alternative Part No	612032001	Alternative Part No	612035011	Alternative Part No	612035021	Alternative Part No	612035031
Repair Kits	EKGH.26	Repair Kits	---	Repair Kits	---	Repair Kits	---
14.03.1007 		--- 		--- 		--- 	
Alternative Part No	612035041	Alternative Part No	612035051	Alternative Part No	612035071	Alternative Part No	612046211
Repair Kits	---	Repair Kits	---	Repair Kits	---	Repair Kits	---
--- 		--- 		14.03.1008 		--- 	
Alternative Part No	612046261	Alternative Part No	612047002	Alternative Part No	612048111	Alternative Part No	612048131
Repair Kits	---	Repair Kits	---	Repair Kits	---	Repair Kits	---

EBS LOAD LEVELLING VALVES - HALDEX / NEWAY





---		14.03.1001		---		14.03.1005 (Imperial Ports)	
							
Alternative Part No	612048171	Alternative Part No	612056021	Alternative Part No	612057001	Alternative Part No	90054007
Repair Kits	---	Repair Kits	---	Repair Kits	---	Repair Kits	---
14.03.1006 (Metric Ports)		14.03.1003		14.13.1000		---	
							
Alternative Part No	90554114 90554147 90554183	Alternative Part No	90554243	Alternative Part No	90554273	Alternative Part No	90554648
Repair Kits	---	Repair Kits	---	Repair Kits	---	Repair Kits	---











For levelling valve linkages and rods see page 14.15



LOAD LEVELLING VALVES

EBS LOAD LEVELLING VALVES - KNORR BREMSE

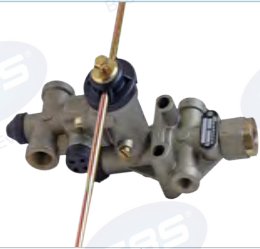
14.04.1013	14.04.1014	14.04.1015	14.04.1016
			
Right hand mounting - Lever 185mm	Left hand mounting - Lever 185mm	Right hand mounting - Lever 160mm	Left hand mounting - Lever 160mm
Alternative Part No	K003089	Alternative Part No	K003090
Repair Kits	---	Alternative Part No	K005589
		Repair Kits	---
			Alternative Part No
			K005590
			Repair Kits

14.04.1017	14.01.1360	---	---
			
Alternative Part No	K005591	Alternative Part No	I90706 SV1200
Repair Kits	---	Alternative Part No	I90708 SV1202
		Repair Kits	EKKB.29.1
			Alternative Part No
			I47854 SV1230
			Repair Kits
			EKKB.29.1
14.02.1260	---	---	14.02.1280
			
Alternative Part No	I83699 SV1260	Alternative Part No	I58921 SV1261
Repair Kits	EKKB.29.2C	Alternative Part No	I80086 SV1269
		Repair Kits	EKKB.29.2C
			Alternative Part No
			I80093 SV1280
			Repair Kits
			EKKB.29.2C
14.02.1281	14.02.1287	14.02.1288	14.02.1294
			
Alternative Part No	I80095 SV1281	Alternative Part No	I117813 SV1288
Repair Kits	EKKB.29.1	Alternative Part No	K002335 SV1294
		Repair Kits	EKKB.29.2C
			Alternative Part No
			K002335 SV1294
			Repair Kits
			EKKB.29.2C

EBS LOAD LEVELLING VALVES - KNORR BREMSE

14.02.1295 	---	14.02.1380 	---
Alternative Part No I85698 SV1295	Alternative Part No I83640 SV1296	Alternative Part No I133045 SV1298	Alternative Part No I85444 SV1299
Repair Kits EKKB.29.1	Repair Kits EKKB.29.1	Repair Kits EKKB.29.2C	Repair Kits EKKB.29.2C
14.02.1303 	14.02.1304 	14.02.1307 	14.02.1310 
Alternative Part No I132763 SV1303	Alternative Part No I85919 SV1304	Alternative Part No I87823 SV1307	Alternative Part No I82456 SV1310
Repair Kits EKKB.29.2C	Repair Kits EKKB.29.2C	Repair Kits EKKB.29.2C	Repair Kits EKKB.29.2C
14.02.1318 	---	14.02.1323 	14.02.1325 
Alternative Part No I85883 SV1318	Alternative Part No I118034 SV1321	Alternative Part No I132764 SV1323	Alternative Part No I118033 SV1325
Repair Kits EKKB.29.2C	Repair Kits EKKB.29.2C	Repair Kits EKKB.29.2C	Repair Kits EKKB.29.2C
14.02.1328 	14.02.1329 	---	---
Alternative Part No I132765 SV1328	Alternative Part No I92103 SV1329	Alternative Part No I92104 SV1330	Alternative Part No I86888 SV1334
Repair Kits EKKB.29.2C	Repair Kits EKKB.29.2C	Repair Kits EKKB.29.2C	Repair Kits EKKB.29.2C

For levelling valve linkages and rods see page 14.15

LOAD LEVELLING VALVES

EBS LOAD LEVELLING VALVES - KNORR BREMSE

14.02.1343		14.02.1344		14.02.1345		14.02.1350	
Alternative Part No	I87432 SV1343	Alternative Part No	I87433 SV1344	Alternative Part No	II17814 SV1345	Alternative Part No	I87950 SV1350
Repair Kits	EKKB.29.2C	Repair Kits	EKKB.29.2C	Repair Kits	EKKB.29.2C	Repair Kits	EKKB.29.2C
14.02.1351		---		14.02.1361		14.02.1362	
Alternative Part No	K002334 SV1351	Alternative Part No	II18035 SV1352	Alternative Part No	I90452 SV1361	Alternative Part No	II18032 SV1362
Repair Kits	EKKB.29.2C	Repair Kits	EKKB.29.2C	Repair Kits	EKKB.29.2C	Repair Kits	EKKB.29.2C
---		14.02.1370		14.02.1371		14.02.1376	
Alternative Part No	I92567 SV1369	Alternative Part No	I92568 SV1370	Alternative Part No	SV1371	Alternative Part No	I93422 SV1376
Repair Kits	EKKB.29.2C	Repair Kits	EKKB.29.2C	Repair Kits	EKKB.29.2C	Repair Kits	EKKB.29.2C
---		---		14.02.1380		---	
Alternative Part No	I93497 SV1377	Alternative Part No	I93498 SV1378	Alternative Part No	II36026 SV1380	Alternative Part No	II36027 SV1381
Repair Kits	EKKB.29.2C	Repair Kits	EKKB.29.2C	Repair Kits	EKKB.29.2C	Repair Kits	EKKB.29.2C

EBS LOAD LEVELLING VALVES - KNORR BREMSE

---		14.02.1395		14.02.1399		14.02.1425	
							
Alternative Part No	II17815 SV1385	Alternative Part No	II19425 SV1395	Alternative Part No	II30525000 SV1399	Alternative Part No	I98348 SV1403
Repair Kits	EKKB.29.2C	Repair Kits	EKKB.29.2C	Repair Kits	EKKB.29.1	Repair Kits	EKKB.29.2C
14.02.1426		14.02.1410		14.02.1411		14.02.1412	
							
Alternative Part No	I98349 SV1404	Alternative Part No	I98289 SV1410	Alternative Part No	I98290 SV1411	Alternative Part No	K000073 SV1412
Repair Kits	EKKB.29.2C	Repair Kits	EKKB.29.2C	Repair Kits	EKKB.29.2C	Repair Kits	EKKB.29.2C
---		---		---		14.02.1425	
							
Alternative Part No	I99631 SV1417	Alternative Part No	II15729 SV1421	Alternative Part No	II15730 SV1422	Alternative Part No	II16189 SV1425
Repair Kits	EKKB.29.2C	Repair Kits	EKKB.29.2C	Repair Kits	EKKB.29.2C	Repair Kits	EKKB.29.2C
14.02.1426		---		14.02.1440		---	
							
Alternative Part No	II16190 SV1426	Alternative Part No	II17811 SV1430	Alternative Part No	II30530 SV1440	Alternative Part No	II30531 SV1441
Repair Kits	EKKB.29.2C	Repair Kits	EKKB.29.2C	Repair Kits	EKKB.29.2C	Repair Kits	EKKB.29.2C

For levelling valve linkages and rods see page 14.15

LOAD LEVELLING VALVES

EBS LOAD LEVELLING VALVES - KNORR BREMSE

---		14.02.1447		---		---	
							
Alternative Part No	I134439 SV1445	Alternative Part No	I134910 SV1447	Alternative Part No	I136088 SV1460	Alternative Part No	I136141 SV1461
Repair Kits	EKKB.29.2C	Repair Kits	EKKB.29.2C	Repair Kits	EKKB.29.2C	Repair Kits	EKKB.29.2C
---		14.02.1465		14.02.1466		---	
							
Alternative Part No	I136142 SV1463	Alternative Part No	I136114 SV1465	Alternative Part No	I136115 SV1466	Alternative Part No	I136169 SV1481
Repair Kits	EKKB.29.1	Repair Kits	EKKB.29.2C	Repair Kits	EKKB.29.2C	Repair Kits	EKKB.29.2C
---		---		14.02.1490		---	
							
Alternative Part No	I136171 SV1482	Alternative Part No	K002647 SV1485	Alternative Part No	S1490 K000264	Alternative Part No	SV1494
Repair Kits	EKKB.29.2C	Repair Kits	EKKB.29.2C	Repair Kits	---	Repair Kits	EKKB.29.2C

EBS LOAD LEVELLING VALVES - WABCO

14.01.1310		14.01.1312		14.01.1330		14.01.1332	
							
Alternative Part No	4640023100 4640023330	Alternative Part No	4640023120	Alternative Part No	4640023300	Alternative Part No	4640023320
Repair Kits	EKWA.26 or EKWA.26.1	Repair Kits	EKWA.26 or EKWA.26.1	Repair Kits	EKWA.26 or EKWA.26.1	Repair Kits	EKWA.26 or EKWA.26.1
14.01.1360		14.01.1530		14.01.1532		14.01.2000	
							
Alternative Part No	4640023600	Alternative Part No	4640025300	Alternative Part No	4640025320	Alternative Part No	4640040000
Repair Kits	EKWA.26 or EKWA.26.1	Repair Kits	EKWA.26 or EKWA.26.1	Repair Kits	EKWA.26 or EKWA.26.1	Repair Kits	EKWA.26.4
---		14.01.3000		14.01.3002		14.01.3012	
							
Alternative Part No	4640050040	Alternative Part No	4640060000	Alternative Part No	4640060010 4640060020 4640060110	Alternative Part No	4640060120
Repair Kits	---	Repair Kits	EKWA.26.3 or EKWA.26.1	Repair Kits	EKWA.26.3 or EKWA.26.1	Repair Kits	EKWA.26.3 or EKWA.26.1
14.01.3100		---					
							
Alternative Part No	4640061000 4640062010	Alternative Part No	4640080030				
Repair Kits	EKWA.26.3 or EKWA.26.1	Repair Kits	---				

LOAD LEVELLING VALVES

For levelling valve linkages and rods see page 14.15

EBS ELC LEVELLING VALVES - KNORR BREMSE

14.02.1000	
	
Alternative Part No	0504002107000 K013741N00 20850557 8144352
Repair Kits	---

14.02.1001	
	
Alternative Part No	0504002113100
Repair Kits	---

	
Alternative Part No	0504003001000
Repair Kits	---



EBS ECAS HEIGHT SENSORS - WABCO

14.01.6006	
	
Alternative Part No	4410500060
Repair Kits	EKWA.106
Application	Connection
DAF MAN	

14.01.6007	
	
Alternative Part No	4410500070
Repair Kits	EKWA.106
Application	Connection
RENAULT	

14.01.6008	
	
Alternative Part No	4410500080
Repair Kits	EKWA.106
Application	Connection
DAF MAN MERCEDES RENAULT SCANIA	

14.01.6010	
	
Alternative Part No	4410500100
Repair Kits	EKWA.106
Application	Connection
RENAULT & TRAILERS	

EBS ECAS HEIGHT SENSORS - WABCO

















14.01.6011		14.01.6012		14.01.6013		14.01.6100	
							
Alternative Part No	4410500110 8840110840	Alternative Part No	4410500120	Alternative Part No	4410500130	Alternative Part No	4410501000 1365935
Repair Kits	EKWA.106	Repair Kits	EKWA.106	Repair Kits	EKWA.106	Repair Kits	---
Application	Connection	Application	Connection	Application	Connection	Application	Connection
DAF IVECO MAN SCANIA & TRAILERS		MAN MERCEDES		RENAULT		DAF	

14.01.6101		14.01.6120		14.01.6121		14.01.6122	
							
Alternative Part No	4410501010	Alternative Part No	4410501200 41200708	Alternative Part No	4410501210	Alternative Part No	4410501220
Repair Kits	---	Repair Kits	---	Repair Kits	---	Repair Kits	---
Application	Connection	Application	Connection	Application	Connection	Application	Connection
DAF		IVECO		MERCEDES		SCANIA	

14.01.6123		14.01.6202		14.01.6203	
					
Alternative Part No	4410501230	Alternative Part No	4410502020	Alternative Part No	4410502030
Repair Kits	---	Repair Kits	---	Repair Kits	---
Application	Connection	Application	Connection	Application	Connection
MAN		WABCO		MERCEDES MAN SCANIA	

LOAD LEVELLING VALVES

LINKAGES, RODS & RUBBERS

14.03.1009	---	14.03.1000	---
			
Alternative Part No 003575709	Alternative Part No 02.4901.49.00	M8 THREAD Alternative Part No 612025001	Alternative Part No 1111984010
14.01.7002	14.01.7025	---	EKWA.64.2
			
Alternative Part No 4333020020	Alternative Part No 4333020250	M8 THREAD Alternative Part No 4334010030	Alternative Part No 4410507182
EKWA.64	EKWA.64.1	14.01.9730	---
	 8mm - Standard Type		 8mm - P Type To suit 4757120000
Alternative Part No 4640027302	Alternative Part No 4757017122	6mm - P Type Alternative Part No 4640067302 1119099 ZB3130	Alternative Part No 4757127102
14.03.1010	14.06.3027	14.06.1037	---
			
Alternative Part No 48100287	M10 THREAD Alternative Part No KW3027	M10 THREAD Alternative Part No KX1037/1	Alternative Part No 4757137102

LINKAGES, RODS & RUBBERS

---		---		---		---	
							
Alternative Part No	KX1125/1	M8 THREAD	SEB00256	Alternative Part No	4333003814	Alternative Part No	4333003834
---		---		---		---	
							
Alternative Part No	4333003854	Alternative Part No	4334013804	Alternative Part No	90054630		

EBS BOSCH REPAIR KITS

EKBO.3		EKBO.3.1		EKBO.3.2		EKBO.3.4	
							
EKBO.3.3		SEKBO.3		EKS.0041 HARD		EKS.0042 SOFT	
							

EBS HALDEX / NEWAY REPAIR KITS

EKGH.26

LOAD LEVELLING VALVES

EBS KNORR BREMSE REPAIR KITS



EBS WABCO REPAIR KITS



LOAD SENSING VALVES

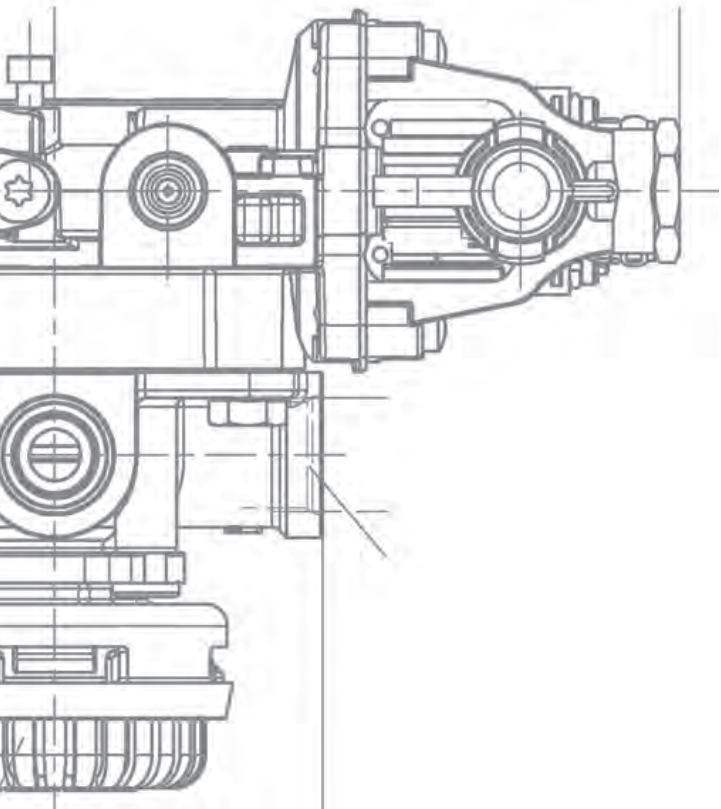
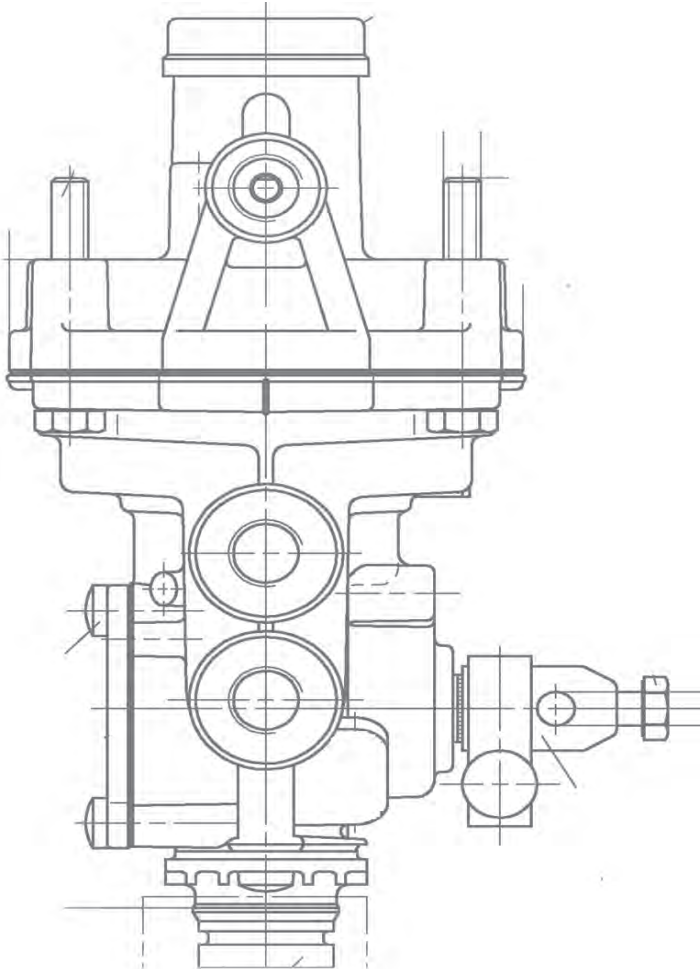

EBS LOAD SENSING VALVES - BOSCH

Alternative Part No	0481036102000	Alternative Part No	0481036105000	Alternative Part No	0481036117000	Alternative Part No	0481036206000
Repair Kits	EKBO.11.2	Repair Kits	EKBO.11.2	Repair Kits	EKBO.11.2	Repair Kits	EKBO.11.2
Alternative Part No	0481065004000	Alternative Part No	0481065101000	Alternative Part No	0481065102000	Alternative Part No	0481065103000
Repair Kits	---	Repair Kits	---	Repair Kits	---	Repair Kits	---
Alternative Part No	0481099011000	Alternative Part No	0481099012000				
Repair Kits	---	Repair Kits	---				

EBS LOAD SENSING VALVES - BENDIX

EBS Part No	Images	Alternative	Repair Kit
15.06.1007	1	1186938	EKBE.58
15.06.1008		1189096	EKBE.58
15.06.1009		1189097	EKBE.58
15.06.1001		KY807/1	EKBE.58
15.06.1003		KY1038/3	EKBE.58
15.06.1004	2	KY2184/2	EKBE.58
15.06.1002		KY890/1	EKBE.58
---		KY952/4	EKBE.58
15.06.1000		KY982/6	EKBE.58
---	3	KY1932/1	EKBE.58
---		KY1952/1	EKBE.58
---		KY1956/3	EKBE.58
---		KY1994/2	EKBE.58
15.06.1003		KY2184/1	EKBE.58
15.06.1005		KY2193/1	EKBE.58
15.06.1006		KY2193/2	EKBE.58



EBS LOAD SENSING VALVES - DAHL (Paul Dahl)

EBS Part No	Images	Alternative	Repair Kit
---	4	1111850000	EKPD.3
---		1111950000	EKPD.3
---		1111951000	EKPD.3
---		1111954000	EKPD.3
R15.08.1002		1111961000	EKPD.3
---		1111962000AT	EKPD.3
---	5	1111980000	EKPD.3
R15.08.1001	6	1111995000AT	EKPD.3
		1111999000	EKPD.3
---		1112001000	EKPD.3

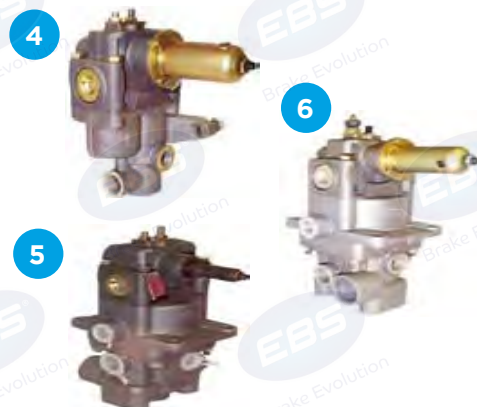

EBS LOAD SENSING VALVES - HALDEX

R15.03.1001		R15.03.1002		26.01.G011		---	
Alternative Part No	351012001	Alternative Part No	351014001	Alternative Part No	352011102	Alternative Part No	601002001
Repair Kits	EKGH.3	Repair Kits	EKGH.3	Repair Kits	---	Repair Kits	EKGH.3
---		---		---		15.03.1000	
Alternative Part No	601002021	Alternative Part No	601013001	Alternative Part No	601013011	Alternative Part No	602005001
Repair Kits	EKGH.3	Repair Kits	EKGH.3	Repair Kits	EKGH.3	Repair Kits	EKGH.3
---		---		---		---	
Alternative Part No	613005001	---		---		---	
Repair Kits	---	---		---		---	

For levelling valve linkages and rods see page 15.11

LOAD SENSING VALVES

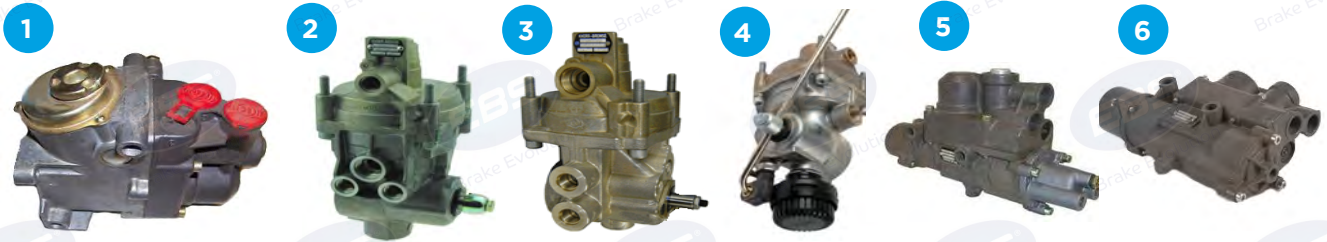

EBS LOAD SENSING VALVES - KNORR BREMSE

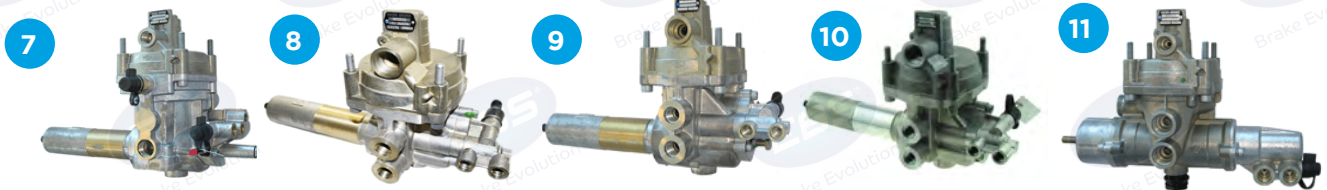

EBS Part No	Images	Alternative	Repair Kit
---	1	BR4253	EKKB.71
---	1	BR4255	EKKB.71
---	1	BR4263	EKKB.71
---	1	BR4265	EKKB.71
---	2	BR4351	EKKB.44
---	2	BR4352	EKKB.44
15.01.6500	3	BR4370	EKKB.42
---	3	BR4410	EKKB.42
---	3	BR4411	EKKB.42
---	3	BR4412	EKKB.42
15.02.4413	3	BR4413	EKKB.42
15.01.3025	3	BR4414	EKKB.42
15.01.3024	3	BR4415	EKKB.42
---	3	BR4421	EKKB.42
15.01.3007	3	BR4423	EKKB.42
---	3	BR4431	EKKB.42
15.01.3012	3	BR4439	EKKB.42
---	4	BR4440	EKKB.42
15.02.4441	3	BR4441	EKKB.42
---	3	BR4442	EKKB.42
---	3	BR4444	EKKB.42
---	4	BR4452	EKKB.42
---	4	BR4453	EKKB.42
15.01.3016	4	BR4454	EKKB.42
---	3	BR4455	EKKB.42
15.01.3135	3	BR4456	EKKB.42
15.01.3134	3	BR4457	EKKB.42
---	4	BR4465	EKKB.42

EBS Part No	Images	Alternative	Repair Kit
15.01.3135	3	BR4466	EKKB.42
---	3	BR4467	EKKB.42
---	4	BR4468	EKKB.42
15.02.4470	3	BR4470	EKKB.42
---	5	BR5325	EKKB.71
R15.02.5408	6	BR5408	EKKB.71
---	7	BR5503	EKKB.44.2
---	7	K037585N00	EKKB.44.2
R15.02.5504	7	BR5504 K037584N00	EKKB.44.2
---	8	BR5522	EKKB.44.2
---	9	BR5524	EKKB.44.2
---	10	BR5530	EKKB.44.2
---	11	BR5604	EKKB.44.2
15.01.4012	11	BR5607	EKKB.42
15.01.4032	11	BR5608	EKKB.42
15.01.4011	11	BR5611	EKKB.42
15.01.4099	11	BR5615	EKKB.42
---	11	BR5616	EKKB.42
---	11	BR5617	EKKB.42
15.02.5619	11	BR5619	EKKB.42
---	11	BR5628	EKKB.42
---	11	BR5633	EKKB.42
---	11	BR5643	EKKB.42
---	11	BR5645	EKKB.42
---	11	BR5648	EKKB.42
15.01.4087	11	BR5655	EKKB.42
---	11	BR5657	EKKB.42
---	5	BR5712	EKKB.71



For levelling valve linkages and rods see page 15.11

EBS LOAD SENSING VALVES - MAGNETI MARELLI

---		---		R15.07.1000		---	
	Alt.	MP13AX	MP51AX				
		---	---				
	Alt.	MP51AY	MP51CY	Alternative Part No	MP70A	Alternative Part No	MS10A
Repair Kits	---			Repair Kits	---	Repair Kits	---

EBS LOAD SENSING VALVES - HYDRAULIC - WABCO 468 SERIES



EBS Part No	---	---	---	---	---
Alternative Part No	4684020020	4684020080	4684042530	4684060000	4684060010
Repair Kits	---				

EBS LOAD SENSING VALVES - WABCO 475700 SERIES



EBS Part No	15.01.1120	15.01.1122	15.01.1126	15.01.1220	---	15.01.1401
Alternative Part No	4757001200	4757001220	4757001260	4757002200	4757004300	4757004010
Repair Kits	EKWA.45					
EBS Part No	15.01.1402	15.01.1403	15.01.1404	---		
Alternative Part No	4757004020	4757004030	4757004040	4757004300		
Repair Kits	EKWA.45					

EBS LOAD SENSING VALVES - WABCO 475701 SERIES



EBS Part No	15.01.2001
Alternative Part No	4757010010
Repair Kits	EKBE.58



EBS Part No	---	---	---	---	15.01.2020	---
Alternative Part No	4757010030	4757010050	4757010060	4757010070	4757010200	4757010210
Repair Kits	EKBE.58					

EBS LOAD SENSING VALVES - WABCO 475702 SERIES



EBS Part No	---	---	---	---
Alternative Part No	4757020000	4757020020	4757020200	4757020220
Repair Kits	EKBE.58			

LOAD SENSING VALVES



EBS LOAD SENSING VALVES - WABCO 475710 SERIES

EBS Part No	Images	Alternative	Repair Kit	Repair Kit	Repair Kit
15.01.3000	1	4757100000	EKWA.42	EKWA.74	EKWA.42.D
15.01.3002		4757100020	EKWA.42	EKWA.74	EKWA.42.D
15.01.3003		4757100030	EKWA.42	EKWA.74	EKWA.42.D
15.01.3006		4757100060	EKWA.42	EKWA.74	EKWA.42.D
15.01.3007		4757100070	EKWA.42	EKWA.74	EKWA.42.D
15.01.3008		4757100080	EKWA.42	EKWA.74	EKWA.42.D
15.01.3009		4757100090	EKWA.42	EKWA.74	EKWA.42.D
15.01.3011		4757100110	EKWA.42	EKWA.74	EKWA.42.D
15.01.3012		4757100120	EKWA.42	EKWA.74	EKWA.42.D
15.01.3013		4757100130	EKWA.42	EKWA.74	EKWA.42.D
15.01.3014		4757100140	EKWA.42	EKWA.74	EKWA.42.D
15.01.3016		4757100160	EKWA.42	EKWA.74	EKWA.42.D
15.01.3020		4757100200	EKWA.42	EKWA.74	EKWA.42.D
15.01.3021		4757100210	EKWA.42	EKWA.74	EKWA.42.D
15.01.3022		4757100220	EKWA.42	EKWA.74	EKWA.42.D
15.01.3024		4757100240	EKWA.42	EKWA.74	EKWA.42.D
15.01.3025		4757100250	EKWA.42	EKWA.74	EKWA.42.D
15.01.3028		4757100280	EKWA.42	EKWA.74	EKWA.42.D
15.01.3029		4757100290	EKWA.42	EKWA.74	EKWA.42.D
15.01.3031		4757100310	EKWA.42	EKWA.74	EKWA.42.D
15.01.3032		4757100320	EKWA.42	EKWA.74	EKWA.42.D
15.01.3033		4757100330	EKWA.42	EKWA.74	EKWA.42.D
15.01.3035		4757100350	EKWA.42	EKWA.74	EKWA.42.D
15.01.3036		4757100360	EKWA.42	EKWA.74	EKWA.42.D
15.01.3039		4757100390	EKWA.42	EKWA.74	EKWA.42.D
15.01.3040		4757100400	EKWA.42	EKWA.74	EKWA.42.D
15.01.3041		4757100410	EKWA.42	EKWA.74	EKWA.42.D
15.01.3042		4757100420	EKWA.42	EKWA.74	EKWA.42.D
15.01.3044		4757100440	EKWA.42	EKWA.74	EKWA.42.D
15.01.3121		4757101210	EKWA.42	EKWA.74	EKWA.42.D
15.01.3122		4757101220	EKWA.42	EKWA.74	EKWA.42.D
15.01.3125		4757101250	EKWA.42	EKWA.74	EKWA.42.D
15.01.3128	4757101280	EKWA.42	EKWA.74	EKWA.42.D	
15.01.3129	4757101290	EKWA.42	EKWA.74	EKWA.42.D	
15.01.3130	4757101300	EKWA.42	EKWA.74	EKWA.42.D	
15.01.3131	4757101310	EKWA.42	EKWA.74	EKWA.42.D	
15.01.3134	4757101340	EKWA.42	EKWA.74	EKWA.42.D	
15.01.3135	4757101350	EKWA.42	EKWA.74	EKWA.42.D	
15.01.3136	4757101360	EKWA.42	EKWA.74	EKWA.42.D	
15.01.3128	4757101560	EKWA.42	EKWA.74	EKWA.42.D	

For levelling valve linkages and rods see page 15.11

EBS LOAD SENSING VALVES - WABCO 475711 SERIES

EBS Part No	Image	Alternative	Repair Kit	Repair Kit	Repair Kit	Repair Kit
15.01.4000	2	4757110000	EKWA.43	EKWA.74	EKWA.43.D	---
15.01.4001		4757110010	EKWA.43	EKWA.74	EKWA.43.D	---
15.01.4002		4757110020	EKWA.43	EKWA.74	EKWA.43.D	---
15.01.4003		4757110030	EKWA.43	EKWA.74	EKWA.43.D	---
15.01.4004		4757110040	EKWA.43	EKWA.74	EKWA.43.D	---
15.01.4006		4757110060	EKWA.43	EKWA.74	EKWA.43.D	---
15.01.4007		4757110070	EKWA.43	EKWA.74	EKWA.43.D	---
15.01.4008		4757110080	EKWA.43	EKWA.74	EKWA.43.D	---
15.01.4009		4757110090	EKWA.43	EKWA.74	EKWA.43.D	---
15.01.4010		4757110100	EKWA.43	EKWA.74	EKWA.43.D	---
15.01.4011		4757110110	EKWA.43	EKWA.74	EKWA.43.D	---
15.01.4012		4757110120	EKWA.43	EKWA.74	EKWA.43.D	---
15.01.4013		4757110130	EKWA.43	EKWA.74	EKWA.43.D	---
15.01.4014		4757110140	EKWA.43	EKWA.74	EKWA.43.D	---
15.01.4017		4757110170	EKWA.43	EKWA.74	EKWA.43.D	---
15.01.4020		4757110200	EKWA.43	EKWA.74	EKWA.43.D	---
15.01.4021		4757110210	EKWA.43	EKWA.74	EKWA.43.D	---
15.01.4022		4757110220	EKWA.43	EKWA.74	EKWA.43.D	---
15.01.4023		4757110230	EKWA.43	EKWA.74	EKWA.43.D	---
15.01.4024		4757110240	EKWA.43	EKWA.74	EKWA.43.D	---
15.01.4025		4757110250	EKWA.43	EKWA.74	EKWA.43.D	---
15.01.4026		4757110260	EKWA.43	EKWA.74	EKWA.43.D	---
15.01.4027		4757110270	EKWA.43	EKWA.74	EKWA.43.D	---
15.01.4028		4757110280	EKWA.43	EKWA.74	EKWA.43.D	---
15.01.4029		4757110290	EKWA.43	EKWA.74	EKWA.43.D	---
15.01.4030		4757110300	EKWA.43	EKWA.74	EKWA.43.D	---
15.01.4031		4757110310	EKWA.43	EKWA.74	EKWA.43.D	---
15.01.4032		4757110320	EKWA.43	EKWA.74	EKWA.43.D	---
15.01.4033		4757110330	EKWA.43	EKWA.74	EKWA.43.D	---
15.01.4034		4757110340	EKWA.43	EKWA.74	EKWA.43.D	---
15.01.4036		4757110360	EKWA.43	EKWA.74	EKWA.43.D	---
15.01.4037		4757110370	EKWA.43	EKWA.74	EKWA.43.D	---
15.01.4038		4757110380	EKWA.43	EKWA.74	EKWA.43.D	---
15.01.4039		4757110390	EKWA.43	EKWA.74	EKWA.43.D	---
15.01.4040		4757110400	EKWA.43	EKWA.74	EKWA.43.D	---
15.01.4041		4757110410	EKWA.43	EKWA.74	EKWA.43.D	90.01.2050
15.01.4042		4757110420	EKWA.43	EKWA.74	EKWA.43.D	90.01.2050
15.01.4045		4757110450	EKWA.43	EKWA.74	EKWA.43.D	90.01.2050
15.01.4046		4757110460	EKWA.43	EKWA.74	EKWA.43.D	90.01.2050
15.01.4051		4757110510	EKWA.43	EKWA.74	EKWA.43.D	90.01.2050
15.01.4052		4757110520	EKWA.43	EKWA.74	EKWA.43.D	90.01.2050
15.01.4054		4757110540	EKWA.43	EKWA.74	EKWA.43.D	90.01.2050
15.01.4057		4757110570	EKWA.43	EKWA.74	EKWA.43.D	90.01.2050
15.01.4058		4757110580	EKWA.43	EKWA.74	EKWA.43.D	90.01.2050
15.01.4060		4757110600	EKWA.43	EKWA.74	EKWA.43.D	90.01.2050
15.01.4063		4757110630	EKWA.43	EKWA.74	EKWA.43.D	90.01.2050
15.01.4068		4757110680	EKWA.43	EKWA.74	EKWA.43.D	90.01.2050
15.01.4071	4757110710	EKWA.43	EKWA.74	EKWA.43.D	90.01.2050	
15.01.4072	4757110720	EKWA.43	EKWA.74	EKWA.43.D	90.01.2050	
15.01.4074	4757110740	EKWA.43	EKWA.74	EKWA.43.D	90.01.2050	
15.01.4075	4757110750	EKWA.43	EKWA.74	EKWA.43.D	90.01.2050	
15.01.4076	4757110760	EKWA.43	EKWA.74	EKWA.43.D	90.01.2050	

LOAD SENSING VALVES



EBS LOAD SENSING VALVES - WABCO 475711 SERIES

EBS Part No	Image	Alternative	Repair Kit	Repair Kit	Repair Kit	Repair Kit	
15.01.4087	1	4757110870	EKWA.43	EKWA.74	EKWA.43.D	90.01.2050	
15.01.4088		4757110880	EKWA.43	EKWA.74	EKWA.43.D	90.01.2050	
15.01.4089		4757110890	EKWA.43	EKWA.74	EKWA.43.D	90.01.2050	
15.01.4090		4757110900	EKWA.43	EKWA.74	EKWA.43.D	90.01.2050	
15.01.4094		4757110940	EKWA.43	EKWA.74	EKWA.43.D	90.01.2050	
15.01.4096		4757110960	EKWA.43	EKWA.74	EKWA.43.D	---	
15.01.4097		4757110970	EKWA.43	EKWA.74	EKWA.43.D	---	
15.01.4098		4757110980	EKWA.43	EKWA.74	EKWA.43.D	---	
15.01.4099		4757110990	EKWA.43	EKWA.74	EKWA.43.D	---	
15.01.4108		4757111080	EKWA.43	EKWA.74	EKWA.43.D	---	
15.01.4109		4757111090	EKWA.43	EKWA.74	EKWA.43.D	---	
15.01.4110		4757111100	EKWA.43	EKWA.74	EKWA.43.D	---	
15.01.4111		4757111110	EKWA.43	EKWA.74	EKWA.43.D	---	
15.01.4115		2	4757111150	EKWA.43	EKWA.74	EKWA.43.D	90.01.2050
15.01.4117			4757111170	EKWA.43	EKWA.74	EKWA.43.D	---
15.01.4118	4757111180		EKWA.43	EKWA.74	EKWA.43.D	90.01.2050	
15.01.4119	4757111190		EKWA.43	EKWA.74	EKWA.43.D	90.01.2050	
15.01.4120	4757111200		EKWA.43	EKWA.74	EKWA.43.D	90.01.2050	
15.01.4121	3	4757111210	EKWA.43	EKWA.74	EKWA.43.D	90.01.2050	
15.01.4122		4757111220	EKWA.43	EKWA.74	EKWA.43.D	90.01.2050	
15.01.4125		4757111250	EKWA.43	EKWA.74	EKWA.43.D	90.01.2050	
15.01.4126		4757111260	EKWA.43	EKWA.74	EKWA.43.D	90.01.2050	
15.01.4127		4757111270	EKWA.43	EKWA.74	EKWA.43.D	90.01.2050	
15.01.4128		4757111280	EKWA.43	EKWA.74	EKWA.43.D	90.01.2050	
15.01.4129		4757111290	EKWA.43	EKWA.74	EKWA.43.D	90.01.2050	
15.01.4131		4757111310	EKWA.43	EKWA.74	EKWA.43.D	90.01.2050	
15.01.4134		4757111340	EKWA.43	EKWA.74	EKWA.43.D	90.01.2050	
15.01.4136		4757111360	EKWA.43	EKWA.74	EKWA.43.D	90.01.2050	
15.01.4137		4757111370	EKWA.43	EKWA.74	EKWA.43.D	90.01.2050	
15.01.4138		4757111380	EKWA.43	EKWA.74	EKWA.43.D	90.01.2050	
15.01.4142		4757111420	EKWA.43	EKWA.74	EKWA.43.D	90.01.2050	
15.01.4143		4757111430	EKWA.43	EKWA.74	EKWA.43.D	90.01.2050	
15.01.4145		4757111450	EKWA.43	EKWA.74	EKWA.43.D	90.01.2050	
15.01.4146	4757111460	EKWA.43	EKWA.74	EKWA.43.D	90.01.2050		
15.01.4148	4757111480	EKWA.43	EKWA.74	EKWA.43.D	90.01.2050		
15.01.4149	4757111490	EKWA.43	EKWA.74	EKWA.43.D	90.01.2050		
15.01.4150	4757111500	EKWA.43	EKWA.74	EKWA.43.D	90.01.2050		
15.01.4154	4757111540	EKWA.43	EKWA.74	EKWA.43.D	90.01.2050		
15.01.4155	4757111550	EKWA.43	EKWA.74	EKWA.43.D	90.01.2050		
15.01.4159	4757111590	EKWA.43	EKWA.74	EKWA.43.D	90.01.2050		

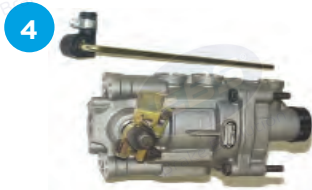

EBS LOAD SENSING VALVES - WABCO 475712 SERIES

EBS Part No	Image	Alternative	Repair Kit	Repair Kit	Repair Kit	Repair Kit
15.01.5000	4	4757120000	EKWA.44	EKWA.75	EKWA.44.D	EKWA.71.A
15.01.5004		4757120040	EKWA.44	EKWA.75	EKWA.44.D	EKWA.71.A

EBS LOAD SENSING VALVES - WABCO 475713 SERIES

EBS Part No	Image	Alternative	Repair Kit	Repair Kit	Repair Kit	Repair Kit
15.01.6000	5	4757130000	EKWA.68	EKWA.76	EKWA.68.D	EKWA.71.A
15.01.6500		4757135000	EKWA.68	EKWA.76	EKWA.68.D	EKWA.71.A
15.01.6501		4757135010	EKWA.68	EKWA.76	EKWA.68.D	EKWA.71.A

EBS LOAD SENSING VALVES - WABCO 475714 SERIES

EBS Part No	Image	Alternative	Repair Kits	Repair Kit	Repair Kit	Repair Kit
15.01.7500	6	4757145000	EKWA.69	EKWA.76	EKWA.69.D	EKWA.71.A
15.01.7503		4757145030	EKWA.69	EKWA.76	EKWA.69.D	EKWA.71.A
15.01.7504		4757145040	EKWA.69	EKWA.76	EKWA.69.D	EKWA.71.A
15.01.7509		4757145090	EKWA.69	EKWA.76	EKWA.69.D	EKWA.71.A
15.01.7510		4757145100	EKWA.69	EKWA.76	EKWA.69.D	EKWA.71.A
15.01.7511		4757145110	EKWA.69	EKWA.76	EKWA.69.D	EKWA.71.A
---		4757146000	EKWA.69	EKWA.76	EKWA.69.D	EKWA.71.A

EBS LOAD SENSING VALVES - WABCO 475715 SERIES

EBS Part No	Image	Alternative	Repair Kits	Repair Kit	Repair Kit	Repair Kit
15.01.8500	7	4757155000	EKWA.71	EKWA.75	EKWA.71.D	EKWA.71.A
15.01.8501		4757155010	EKWA.71	EKWA.75	EKWA.71.D	EKWA.71.A
15.01.8505		4757155050	EKWA.71	EKWA.75	EKWA.71.D	EKWA.71.A
15.01.8507		4757155070	EKWA.71	EKWA.75	EKWA.71.D	EKWA.71.A
15.01.8511		4757155110	EKWA.71	EKWA.75	EKWA.71.D	EKWA.71.A
15.01.8513		4757155130	EKWA.71	EKWA.75	EKWA.71.D	EKWA.71.A
15.01.8514		4757155140	EKWA.71	EKWA.75	EKWA.71.D	EKWA.71.A

For levelling valve linkages and rods see page 15.11

LOAD SENSING VALVES

EBS LOAD SENSING VALVES - WABCO 475720 SERIES



EBS Part No	15.01.9001	15.01.9002	15.01.9003	15.01.9004
Alternative Part No	4757200010	4757200020	4757200030	4757200040
EBS Part No	15.01.9005	15.01.9006	15.01.9500	
Alternative Part No	4757200050	4757200060	4757205000	
Repair Kits	EKWA.73 or 90.01.2050			

EBS LOAD SENSING VALVES - WABCO 475721 SERIES



EBS Part No	---	15.01.0001	15.01.0002	15.01.0003
Alternative Part No	4757210000	4757210010	4757210020	4757210030
EBS Part No	15.01.0004	15.01.0005	15.01.0006	15.01.0007
Alternative Part No	4757210040	4757210050	4757210060	4757210070
EBS Part No	15.01.0009	15.01.0009	15.01.0009	15.01.0009
Alternative Part No	4757210080	4757210090	4757210180	4757210190
EBS Part No	---			
Alternative Part No	4757215030			
Repair Kits	EKWA.73 or 90.01.2050			

EBS LOAD SENSING VALVES - WABCO 475722 SERIES

EBS LOAD SENSING VALVES - WABCO 475800 SERIES

Alternative Part No	4757220000
Repair Kits	---

15.01.A301	
Alternative Part No	4758003010
Repair Kits	EKWA.70

For Silencers please see page 90.9

LINKAGES, RODS & RUBBERS

EBS Part No	Alternative	Unit	EBS Part No	Alternative	Unit
14.03.1009	003575709		---	4757137102	
---	02.4901.49.00		14.03.1010	48100287	
14.03.1000	612025001	 M8 THREAD	SPRINGARM	---	
---	1111984010		14.06.3027	KW3027	 10MM THREAD
14.01.7002	4333020020		14.06.1037	KX1037/1	 10MM THREAD
---	4334010030	 M8 THREAD	---	KX1125/1	
EKWA.64.2	4410507182		---	SEB00256	 8MM THREAD
EKWA.64	4640027302	 6mm - Standard Type	---	4333003814	 8mm - Standard Type
EKWA.64.1	4757017122	 8mm - Standard Type	---	4333003834	 8mm - P Type
14.01.9730	4640067302	 6mm - P Type	---	4333003854	 6mm - P Type
	1119099		---	4334013804	 6mm - Standard Type
---	ZB3130	 8mm - P Type To suit 4757120000	---	90054630	 6 mm

LOAD SENSING VALVES

EBS BOSCH KITS



EBS BENDIX KITS



EBS DAHL KITS(Paul Dahl)



EBS HALDEX KITS



EBS KNORR BREMSE KITS



EBS WABCO KITS

475700 SERIES



475701 / 475702 SERIES



475710 SERIES



475710 SERIES



EBS WABCO KITS

475711 SERIES



475712 / 713 / 714 / 715 SERIES



LOAD SENSING VALVES

475720 / 475721 / 475722 / 475800 / 975700 SERIES

90.01.2050



EKWA.70



EKWA.73



MASTER CYLINDERS & AIR PACKS

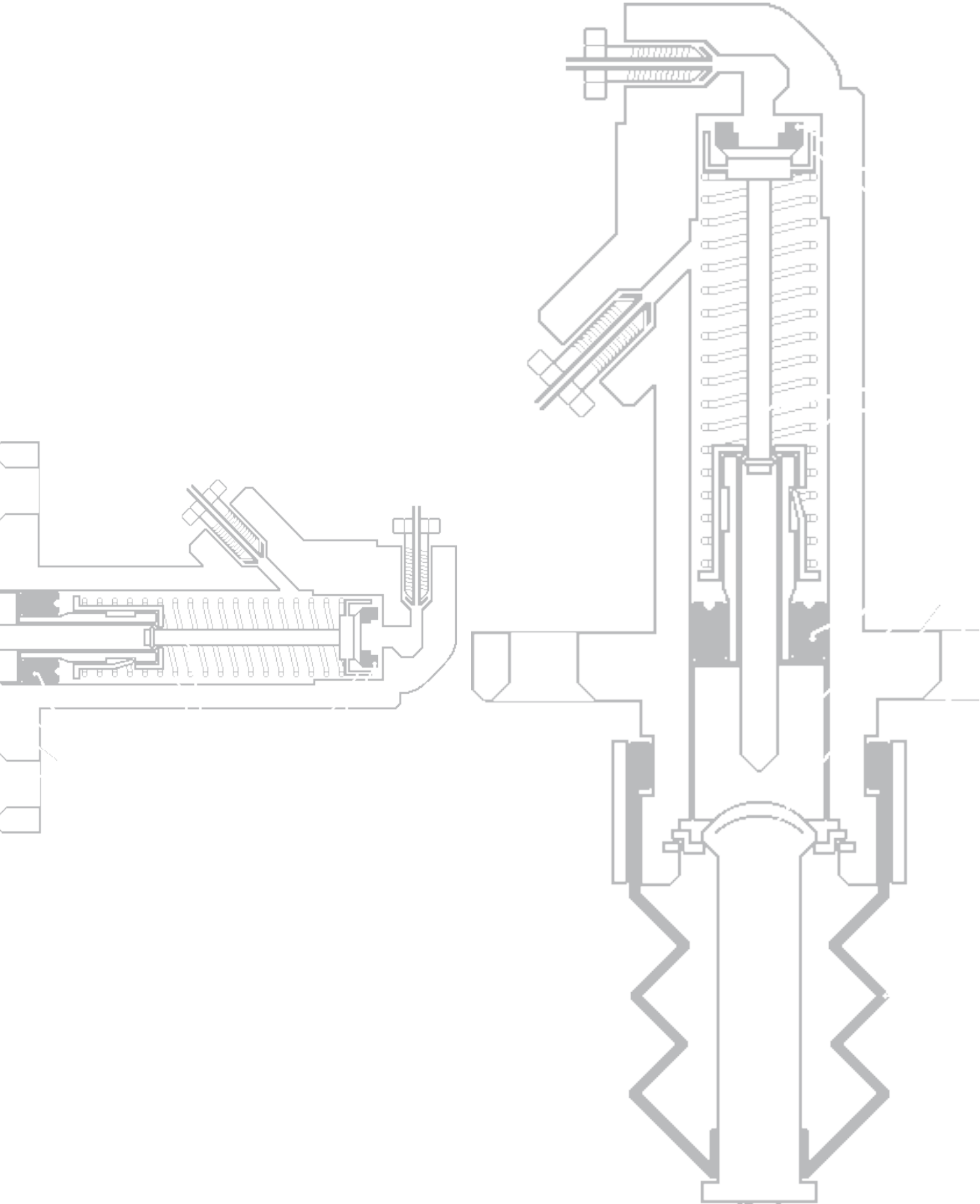

EBS MASTER CYLINDERS - BOSCH

							
Alternative Part No	0483004201000 0014318514	0483004401000 0014317214	0483004601000 0014317114	Alternative Part No	0483004501000 0014317514	0483004701000 0014317314	
Repair Kits	EKBO.6 (OE Ref = 1487010196)			Repair Kits	EKBO.6 (OE Ref = 1487010196)		

EBS MASTER CYLINDERS - FAG / FTE

16.35.1031		16.35.1030		16.35.1034		16.35.1003	
							
Alternative Part No	758188.01SP	Alternative Part No	KG190072.01 0012955206 0012959606	Alternative Part No	KG190084.0.2	Alternative Part No	KG19098.16 6672900212
Repair Kits	---	Repair Kits	---	Repair Kits	---	Repair Kits	EKFA.8 (OE Ref = RK19799 / 0002901812)
16.35.1004		16.35.1036		16.35.1005		---	
							
Alternative Part No	KG20001.0.8 0012959106	Alternative Part No	KG20001.0.10 0012959506	Alternative Part No	KG20010.0.1 0012950106	Alternative Part No	KG2201911 1278342 0012957406
Repair Kits	EKFA.2	Repair Kits	EKFA.2	Repair Kits	EKFA.6	Repair Kits	EKFA.26 (OE Ref = RK22757 / 0002901212)
16.35.1006		16.35.1000		16.35.1010		16.35.1011	
							
Alternative Part No	KG22019.1.4 6732950006	Alternative Part No	KG22026.0.1 1291190	Alternative Part No	KG22027.0.2 81307156140	Alternative Part No	KG22028.0.2 81307156141
Repair Kits	EKFA.9 (OE Ref = RK22762 / 0002904012)	Repair Kits	EKFA.5	Repair Kits	EKFA.10 (OE Ref = RK22761 / 81307156144)	Repair Kits	EKFA.11 (OE Ref = RK22760 / 81307156143)

EBS MASTER CYLINDERS - FAG / FTE



16.35.1018		16.35.1007		16.35.1026		16.35.1027	
							
Alternative Part No	KG23017.1.1 42063311	Alternative Part No	KG23021.1.3 0012952506 0012955306	Alternative Part No	KG23027.0.1 81307156119	Alternative Part No	KG23030.0.2 81307156135
Repair Kits	EKFA.30	Repair Kits	EKFA.12 (OE Ref = RK23719 / 0002902367)	Repair Kits	EKFA.13 (OE Ref = RK23722 / 81307156113)	Repair Kits	EKFA.13 (OE Ref = RK23722 / 81307156113)
16.35.1023		16.35.1028		16.35.1043		16.35.1013	
							
Alternative Part No	KG2394.1.12 1291509 0691041 42558437 02479001	Alternative Part No	KG2395.1.7 0012952906	Alternative Part No	KG2397.1.14	Alternative Part No	KG2397.1.19 3127318 3953328 6028036 6771722 6857432
Repair Kits	EKFA.35	Repair Kits	EKFA.40	Repair Kits	---	Repair Kits	EKFA.22 (OE Ref = RK23725 / 273443 / 276649 / 6771724)
---		16.35.1001		16.35.1014		---	
							
Alternative Part No	KG2397.1.20 5010136472	Alternative Part No	KG250001.0.2 109740 395161 96392	Alternative Part No	KG250004.0.2 1361136	Alternative Part No	KG250005.0.1 1255105
Repair Kits	EKFA.14 (OE Ref = RK23733 / 5001835243)	Repair Kits	EKFA.15 (OE Ref = RK25717 / 1237496 / 696264)	Repair Kits	EKFA.18	Repair Kits	EKFA.19
16.35.1012		---		---		---	
							
Alternative Part No	KG250006.0.2 81307156132	Alternative Part No	KG250009.1.1 4853409	Alternative Part No	KG25011.01	Alternative Part No	KG2595.1.5
Repair Kits	EKFA.16 (OE Ref = RK25718 / 81307156145)	Repair Kits	EKFA.20	Repair Kits	---	Repair Kits	---

MASTER CYLINDERS & AIR PACKS

EBS MASTER CYLINDERS - FAG / FTE





16.35.1015		---		16.35.1032		16.35.1021	
Alternative Part No	KG2595.1.4 292962 355973	Alternative Part No	KG259615 446414	Alternative Part No	KG260411 0012953006 0012950806	Alternative Part No	KG26703.1.1 8282211000
Repair Kits	EKFA.3 (OE Ref = RK25703 / 550440)	Repair Kits	EKFA.27 (OE Ref = RK25705 / 639088)	Repair Kits	EKFA.25 (OE Ref = RK26504 / 0005866029)	Repair Kits	EKFA.33
16.35.1002		16.35.1041		---		16.35.1017	
Alternative Part No	KG28010.0.1 223443 372589 894880	Alternative Part No	KG28011.0.1	Alternative Part No	KG28011.0.1 0260242 0390487 0751820	Alternative Part No	KG28012.0.1 1628218
Repair Kits	EKFA.17 (OE Ref = RK28706 / 1237505)	Repair Kits	---	Repair Kits	EKFA.24 (OE Ref = 1237508 / RK28707)	Repair Kits	EKFA.23 (OE Ref = RK28712)
16.35.1016		16.35.1025		16.35.1009		16.35.1008	
Alternative Part No	KG28014.1.1 1581209 1614351 1620462 1669488	Alternative Part No	KG28019.4.2 20553587 20835246 8172824	Alternative Part No	KG3106.0.1 4853408	Alternative Part No	KG3107.0.1 41211005
Repair Kits	EKFA.7 EKFA.1.1 EKFA.1	Repair Kits	EKFA.37	Repair Kits	EKFA.4	Repair Kits	EKFA.21 EKFA.21.1
16.35.1037		16.35.1029		16.35.1019		16.35.1020	
Alternative Part No	KG3107.1.1 41285356	Alternative Part No	KG3401.0.1 81307156051	Alternative Part No	KN28013.A.1 81307166020	Alternative Part No	KN28014.C.1 81307166082
Repair Kits	EKFA.21	Repair Kits	EKFA.41	Repair Kits	EKFA.31	Repair Kits	EKFA.32

EBS MASTER CYLINDERS - FAG / FTE

16.35.1042		16.35.1024		16.35.1022		16.35.1038	
							
Alternative Part No	KN28022D1	Alternative Part No	KN28027A1 0022950707	Alternative Part No	KN3406.E66	Alternative Part No	MKG190110.4.2
Repair Kits	---	Repair Kits	EKFA.36	Repair Kits	EKFA.34	Repair Kits	---

16.35.1040		16.35.1039		16.35.10000	
					
Alternative Part No	MKG20003.4.2	Alternative Part No	MKG23852.4.3	Alternative Part No	KG2597.1.2
Repair Kits	---	Repair Kits	---	Repair Kits	---

EBS MASTER CYLINDERS - KNORR BREMSE

---		---		16.02.2011		16.02.2123	
							
Alternative Part No	1189421SP	Alternative Part No	1194186	Alternative Part No	K022011N00	Alternative Part No	K032123N50
Repair Kits	---	Repair Kits	---	Repair Kits	---	Repair Kits	---

16.02.3984		16.35.1031		16.35.1033		16.35.1035	
							
Alternative Part No	K013984	Alternative Part No	758188.01SP 4804129 FBU9864	Alternative Part No	KN38017.3.5	Alternative Part No	KN38017.3.6
Repair Kits	---	Repair Kits	---	Repair Kits	---	Repair Kits	---

MASTER CYLINDERS & AIR PACKS

EBS MASTER CYLINDERS - KONGSBERG

16.62.3104		16.62.3105		16.62.3106		16.62.3109	
							
Alternative Part No	623104AM	Alternative Part No	623105AM	Alternative Part No	623106AM 5000792359	Alternative Part No	623109AM 81307156120
Repair Kits	EKPP.28.1	Repair Kits	EKPP.28.2	Repair Kits	EKPP.28.12 (OE Ref = 626243)	Repair Kits	EKPP.28.4 (OE Ref = 625977 / 81307156139)
16.62.3160		16.62.4248		16.62.4502		16.62.4503	
							
Alternative Part No	623160AM 81307156119	Alternative Part No	624248AM 5010251357	Alternative Part No	624502AM 1358801	Alternative Part No	624503AM 1361136
Repair Kits	EKPP.28.5 (OE Ref = 625976 / 81307156138)	Repair Kits	EKPP.28.6 (OE Ref = 626165)	Repair Kits	EKPP.28 (OE Ref = 623157 / 550464)	Repair Kits	EKPP.28 (OE Ref = 623157 / 550464)
16.62.5536		16.62.5826		16.62.6159		16.62.6564	
							
Alternative Part No	625536AM	Alternative Part No	625826AM ACHD274	Alternative Part No	626159AM 5001834842	Alternative Part No	626564AM ACHD722
Repair Kits	---	Repair Kits	EKPP.28.7	Repair Kits	EKPP.28.8 EKPP.28.8.RES	Repair Kits	EKPP.28.7 (OE Ref = 626608 / AMPA852)
16.62.6565		16.62.6760		16.62.6761		16.62.6762	
							
Alternative Part No	626565AM	Alternative Part No	626760AM 1339412	Alternative Part No	626761AM 1348734	Alternative Part No	626762AM 1395485
Repair Kits	---	Repair Kits	EKPP.28 (OE Ref = 627200 / 1373531))	Repair Kits	EKPP.28.10 (OE Ref = 627202 / 1373533)	Repair Kits	EKPP.28.11 (OE Ref = 627201 / 1373532)

EBS MASTER CYLINDERS - KONGSBERG

16.62.7233		16.63.1522	
			
Alternative Part No	627233AM	Alternative Part No	631522AM 1000179039AM 1800442
Repair Kits	---	Repair Kits	---

EBS MASTER CYLINDER AND RESERVOIR - RENAULT

16.62.6159COM	
	
Alternative Part No	5010260052
Repair Kits	---

EBS MASTER CYLINDERS - WABCO

16.01.1520		---		R16.01.2004		R16.01.2006	
							
Alternative Part No	4700125202	Alternative Part No	9213990120	Alternative Part No	9281000042	Alternative Part No	9281000067
Repair Kits	EKWA.18.4C	Repair Kits	EKWA.5	Repair Kits	9741005332	Repair Kits	9741005332

16.01.2006WR		16.01.3902		16.01.4008	
MASTER CYLINDER WITHOUT RESERVOIR					
Alternative Part No	9281000067 9281000042	Alternative Part No	9650019022	Alternative Part No	9740100080
Repair Kits	---	Repair Kits	---	Repair Kits	---

MASTER CYLINDERS & AIR PACKS

EBS BOSCH KITS

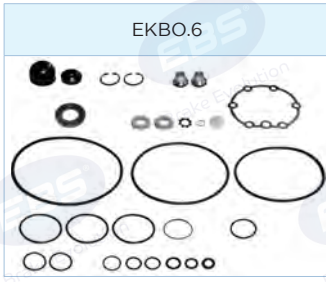

EBS FAG / FTE KITS



EBS FAG / FTE KITS



MASTER CYLINDERS & AIR PACKS

EBS KONGSBERG KITS

<p>EKPP.28</p>	<p>EKPP.28.1</p>	<p>EKPP.28.2</p>	<p>EKPP.28.4</p>	<p>EKPP.28.5</p>
<p>EKPP.28.6</p>	<p>EKPP.28.7</p>	<p>EKPP.28.8</p>	<p>EKPP.28.8.RES</p>	
<p>EKPP.28.10</p>	<p>EKPP.28.11</p>	<p>EKPP.28.12</p>	<p>EKPP.28.14</p>	

EBS KNORR BREMSE KITS

Alternative Part No	1189432
Repair Kits	---

EBS WABCO KITS

<p>EKWA.5</p>	<p>EKWA.18.4C</p>	<p>9741005332</p>
---------------	-------------------	-------------------

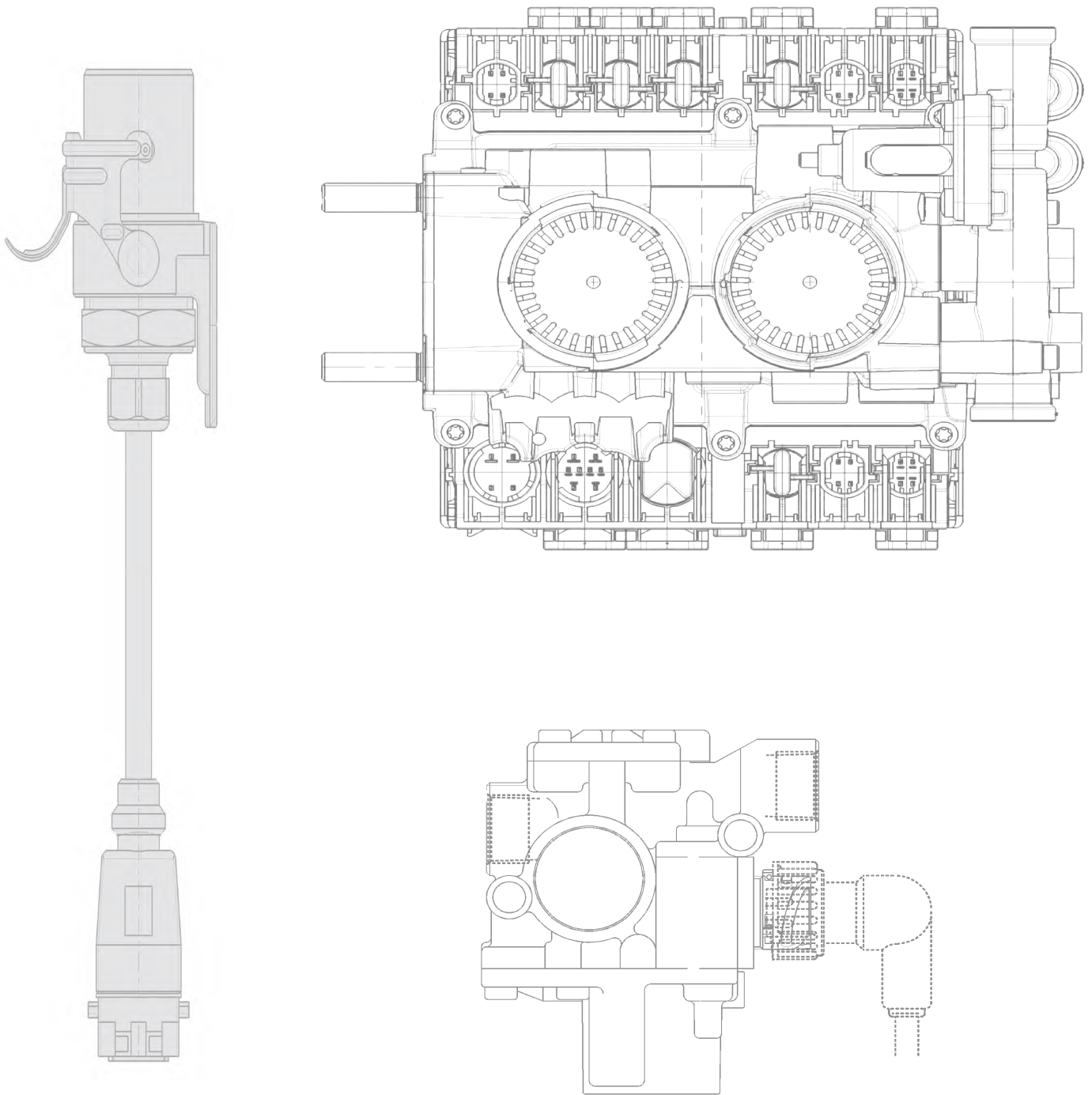

For ABS Sensors & Sensor Extension Cables - Section 30
For ABS Exciter Rings - Section 31
For EBS Coils, "N" & "S" Coils, Sockets & Plugs & Test Equipment - Section 90

ABS SYSTEM PACKAGE - WABCO

EBSVCS2A	
Alternative Part No	4461089212
System	VCS2 (2S/2M)

EBSVCS2B	
Alternative Part No	4461089232
System	VCS2 (4S/2M)

ABS ECU - HALDEX

Alternative Part No	950364081
System	ABS MODAL
Repair Kit	950364021 950364061

R950364101	
Alternative Part No	950364101
System	ABS MGX-2 (Black) 2 Sensor
Repair Kit	950364108

R950364102	
Alternative Part No	950364102
System	ABS MGX-2E (Grey) 2 Sensor
Repair Kit	950364108

R950364103	
Alternative Part No	950364103
System	ABS MGX-100 (Green) 2 Sensor
Repair Kit	950364108

Alternative Part No	950364801A
System	ABS MODULAR 1 UPGRADE 19 Pin 2 Sensor
Repair Kit	---

Alternative Part No	950364802
System	ABS MODULAR 1 UPGRADE 28 Pin 2 Sensor Colas Compatible
Repair Kit	---

Alternative Part No	950364803
System	ABS MODULAR 1 UPGRADE 28 Pin 2/4 Sensor Colas Compatible
Repair Kit	---

Alternative Part No	950364804
System	ABS MODULAR 2 ADR 28 Pin 2/4 Sensor Colas Compatible
Repair Kit	---



ABS ECU - KNORR BREMSE

EBS Part No	Alternative	System	Image	Repair Kit
---	ES1215 1133582	KB3TA		---

ABS ECU - WABCO

---		---		---		---	
Alternative Part No	4005000700	Alternative Part No	4005000810	Alternative Part No	4005001030	Alternative Part No	4460030780
System	Trailer VCS2 2S/2M 2 x ABS Relay Modulato	System	Trailer VCS2 4S/3M 2 x ABS Relay Modulator	System	Trailer VCS2 4S/3M	System	C3 U 6S/6M
Repair Kit	EKWA.57.6E	Repair Kit	EKWA.57.6E	Repair Kit	---	Repair Kit	---

---		---		---		---	
Alternative Part No	4460040650	Alternative Part No	4460040660	Alternative Part No	4460040880	Alternative Part No	4460043110
System	C3 U 4S/4M	System	C3 4S/4M	System	ABS-C3 4S/4M	System	ABS-D Basic 4S/4M
Repair Kit	---	Repair Kit	---	Repair Kit	---	Repair Kit	---

---		---		---		---	
Alternative Part No	4460043130	Alternative Part No	4460043240	Alternative Part No	4460044060	Alternative Part No	4460044160
System	ABS-D Basic 12V 4S/4M W/O ASR	System	ABS-E Basic 4S/4M ABS/ASR	System	ABS-D 4S/4M Blinkcode ASR Lamp	System	ABS-D 4S/4M Blinkcode ABS Lamp
Repair Kit	---	Repair Kit	---	Repair Kit	---	Repair Kit	---

ABS & EBS

ABS ECU - WABCO

					
Alternative Part No	4460044180	Alternative Part No	4460046070	Alternative Part No	4461080850
System	ABS-D 4S/4M	System	ABS-E Basic 4S/4M	System	Trailer VCS 2 4S/3M
Repair Kit	---	Repair Kit	---	Repair Kit	---

ABS VALVES - BOSCH

					
Alternative Part No	0265351102 K0384382N50	Alternative Part No	0265351108	Alternative Part No	0265351118
Repair Kit	---	Repair Kit	---	Repair Kit	---

ABS VALVES - HALDEX

								
Alternative Part No	950364045	Alternative Part No	950364046	Alternative Part No	950364047	Alternative Part No	950364048	
System	ABS MODAL 6 Ports c/w Cable	System	ABS MODAL 2 Ports c/w Cable	System	ABS MODULAR / MODAL 6 Ports	System	ABS MODULAR / MODAL 2 Ports	
Repair Kit	EKGH.57.6 and EKGH.57.FK		EKGH.57.6 and EKGH.57.FK		EKGH.57.6 and EKGH.57.FK		EKGH.57.6 and EKGH.57.FK	

ABS VALVES - HALDEX

17.03.1004		17.03.1005	
			
Alternative Part No	950364076	950364077	
System	ABS MODAL 3 Ports Left Hand c/w Cable	ABS MODAL 3 Ports Right Hand c/w Cable	
Repair Kit	EKGH.57.6 and EKGH.57.FK		

17.03.1000		17.03.1001	
			
Alternative Part No	950364806	950364807	
System	ABS MODULAR 3 Ports Right Hand	ABS MODULAR 3 Ports Left Hand	
Repair Kit	EKGH.57.6 and EKGH.57.FK		

17.03.1008	
	
Alternative Part No	950364104
System	MCER Valve ABS MGX
Repair Kit	EKGH.2.1A or EKGH.2.1C

R17.03.1011	
	
Alternative Part No	950364211
System	ABS DGXi
Repair Kit	EKGH.57.2

	
Alternative Part No	950364018
System	MANIFOLD KIT FOR ABS MODAL 3M SYSTEM
Repair Kit	---

	
Alternative Part No	950364075
System	MANIFOLD KIT FOR ABS MODAL 2M SYSTEM
Repair Kit	---

ABS & EBS

ABS VALVES - KNORR BREMSE

17.02.8438		17.02.9150		---		17.02.4381	
Alternative Part No	BR9154 BR9180 K038438N50 K038435N03	Alternative Part No	BR9131 I93270	Alternative Part No	K038408N50	Alternative Part No	K0384381N50
Repair Kit	---	Repair Kit	EKKB.57.8	Repair Kit	---	Repair Kit	---

17.02.9150		17.02.9151		17.02.9152		17.02.9156	
Alternative Part No	BR9150 K0384382N50	Alternative Part No	BR9151 I115687	Alternative Part No	BR9152 I116278	Alternative Part No	BR9156 I132612
Repair Kit	EKKB.57.8	Repair Kit	EKKB.57.8	Repair Kit	EKKB.57.8	Repair Kit	---

17.02.9159		---		---		---	
Alternative Part No	BR9159 I140864FN00	Alternative Part No	BR9163 I138659F	Alternative Part No	BR9190 I141053F	Alternative Part No	BR9231 I130522
Repair Kit	---	Repair Kit	EKKB.57.8	Repair Kit	EKKB.57.8	Repair Kit	EKKB.57.1.1

---		---		---	
Alternative Part No	BR9232 K125877K50	Alternative Part No	BR9233 I137090N00	Alternative Part No	BR9234 I137091N00
Repair Kit	EKKB.57.1.1	Repair Kit	EKKB.57.1.1	Repair Kit	EKKB.57.1.1

For Silencers please see page 90.8, 90.9

ABS VALVES - WABCO

---		17.01.1051		---		17.01.1004	
							
Alternative Part No	4721950000	Alternative Part No	4721950020	Alternative Part No	4721950030	Alternative Part No	4721950040
Repair Kit	EKWA.57.8	Repair Kit	EKWA.57.8	Repair Kit	EKWA.57.8	Repair Kit	EKWA.57.8

17.01.1016		17.01.1009		17.01.1004		17.01.1011	
							
Alternative Part No	4721950080	Alternative Part No	4721950090	Alternative Part No	4721950100	Alternative Part No	4721950110
Repair Kit	EKWA.57.8	Repair Kit	EKWA.57.8	Repair Kit	EKWA.57.8	Repair Kit	EKWA.57.8

---		17.01.1016		17.01.1018		17.01.1030	
							
Alternative Part No	4721950150	Alternative Part No	4721950160	Alternative Part No	4721950180	Alternative Part No	4721950300
Repair Kit	EKWA.57.8	Repair Kit	EKWA.57.8	Repair Kit	EKWA.57.8	Repair Kit	EKWA.57.6, EKWA.57.5D or EKWA.57.6B

17.01.1031		---		17.01.1040		17.01.1041	
							
Alternative Part No	4721950200 4721950310	Alternative Part No	4721950320 4721950330 4721950210	Alternative Part No	4721950400	Alternative Part No	4721950410
Repair Kit	EKWA.57.6, EKWA.57.5D or EKWA.57.6B	Repair Kit	---	Repair Kit	EKWA.57.6, EKWA.57.5D or EKWA.57.6B	Repair Kit	EKWA.57.6, EKWA.57.5D or EKWA.57.6B

ABS & EBS

ABS VALVES - WABCO

	
Alternative Part No	4721950440
Repair Kit	EKWA.57.6, EKWA.57.5D or EKWA.57.6B

17.01.1051	
	
Alternative Part No	4721950510
Repair Kit	EKWA.57.8

17.01.1055	
	
Alternative Part No	4721950550
Repair Kit	EKWA.57.8

17.01.1058	
	
Alternative Part No	4721950580
Repair Kit	EKWA.57.8

	
Alternative Part No	4721950790
Repair Kit	EKWA.57.8

17.01.1018	
	
Alternative Part No	4721950970
Repair Kit	EKWA.57.8

17.01.1016WC	
	
Universal version Includes cables EKWA.110.3 & EKWA.110.20	
Alternative Part No	4721959202 4721959212 4721959222
Repair Kit	EKWA.57.8

	
Alternative Part No	9721950450
Repair Kit	EKWA.57.8

17.01.1108	
	
Alternative Part No	4721951080
Repair Kit	---

CONVERSION CABLES

EKKB.110.32	
	
Alternative Part No	K015432N00
Repair Kit	---

EKWA.10000	
	
Alternative Part No	8946011612
Repair Kit	---

CONNECTING CABLE

EKWA.10003	
	
Alternative Part No	4493330030
Repair Kit	---



PLUG CONVERSION LEADS				
EBS Part No	Alternative Part No	Information	Unit	Plug Images
EKWA.110.3	8946011322	Length = 0.15M Adaptor Cable From Kostal Connector Into DIN Bayonet Plug = Bayonet (DIN) Port Threads = M24 x 1.5		
EKWA.110.92	8946011392	Length = 0.30M Adaptor Cable From DIN Bayonet Into Female DIN		
EKWA.110.20	---	Adaptor Cable From Square Plug Into DIN Bayonet		
EKWA.110.21	---	Adaptor Cable From Square Plug Into Round Female Plug		
EKWA.110.32	8946011332	Length = 0.15M Adaptor Cable From DIN Bayonet Cable To Kostal		
EKWA.110.62	8946011362	Length = 0.15M Conversion Cable		
EKWA.110.82	8946011382	Length = 0.75M "Y" Adaptor Cable From Male DIN to 2 x Female DIN Plugs		
30.29.2012	---	Length = 0.75M 4 Wire Adaptor Cable To Convert Into A Bayonet Plug.		

ABS & EBS



ABS MODULE - KNORR BREMSE

			
Alternative Part No	ES1301 K003236	Alternative Part No	ES1305 K004236 K004246
Repair Kit	---	Repair Kit	---

EBS CONTROL MODULE - 1 CHANNEL - BOSCH

		R17.04.1023 (MAN)	R17.04.1025 (SCANIA)	R17.04.1030 (RENAULT)	R17.04.1033 (VOLVO)
	Alternative Part No	0486203012 0486203013 0486203016 0486203023 0486203032	0486203005 0486203009 0486203025 0486203026	0486203002 0486203004 0486203017 0486203028 0486203030 0486203031 0486203034	0486203006 0486203014 0486203019 0486203022 0486203024 0486203033
	Repair Kits	EKBO.58.3	EKBO.58.3	EKBO.58.3	EKBO.58.3
		SEAL-2 (Soft Kit)	SEAL-2 (Soft Kit)	SEAL-2 (Soft Kit)	SEAL-2 (Soft Kit)
		EKBO.58CAP.B	EKBO.58CAP.A	EKBO.58CAP.A	EKBO.58CAP.C
R17.02.5415 (OE Ref= K005415)		R17.02.5415 (OE Ref = K005415)	R17.02.5415 (OE Ref = K005415)	R17.02.5415 (OE Ref = K005415)	R17.02.5415 (OE Ref = K005415)

EBS CONTROL MODULE - 2 CHANNEL - BOSCH

		R17.04.2017 (MAN)	R17.04.2019 (SCANIA)	R17.04.2021 (RENAULT)	R17.04.2025 (VOLVO)
	Alternative Part No	0486204008 0486204009 0486204012 0486204017 0486204024	0486204004 0486204006 0486204019 0486204020	0486204001 0486204002 0486204021 0486204023 0486204026	0486204005 0486204010 0486204016 0486204018 0486204025
	Repair Kits	EKBO.58.2			
		SEAL-2 (Soft Kit)			
R17.02.5417 (OE Ref= K005417)		17.02.5417 (OE Ref = K005417)			

EBS TRAILER CONTROL MODULE - BOSCH

		 <p>R17.04.3014 (SCANIA)</p>		 <p>R17.04.3022 (MAN) (RENAULT) (VOLVO)</p>	
Alternative Part No	0486205001 0486205003	0486205014 0486205020	0486205002 0486205004 0486205006 0486205010 0486205011	0486205015 0486205016 0486205017 0486205019 0486205022	
Repair Kit	EKBO.58.1		EKBO.58.1		

EBS CONTROL MODULE - 1 CHANNEL - KNORR BREMSE

		R17.02.1202 (SCANIA)	R17.02.1203 (VOLVO)	17.02.1203	R17.02.1204 (MAN)	R17.02.1203 (IVECO)
	Alternative Part No	K000085N50 K021202N50	K000914N50 K021203N50	K021203	K000913N50 K021204N50 K050211	K000914N50 K023219
Repair Kit	EKKB.49.1 and EKKB.49.CAP					

EBS CONTROL MODULE - 2 CHANNEL - KNORR BREMSE

		R17.02.0022	R17.02.0023 R17.02.1213 R17.02.1411	(IVECO) (RENAULT) (VOLVO)	17.02.0023	R17.02.0024 (MAN)	R17.02.2014 (SCANIA)
	Alternative Part No	K020022N50	K000922N50 K001411 K020022N50 K020023N50 K023213 K093192N50	K020023	K000921N50 K020024N50 K050210	K000086N50 K000088 K020020 K020020N50 K032014N50 K023217N00	
Repair Kit	EKKB.49.2, SEAL-1 and EKKB.49.CAP						

EBS TRAILER CONTROL MODULES - KNORR BREMSE

17.02.0623 / R17.02.0623 (MAN) (RENAULT) (SCANIA) (VOLVO)		R17.02.0624 (VOLVO)	
Alternative Part No	K000089 K000917	K000919 K020622 K020623	K020624
Repair Kit	EKKB.49.3		EKKB.49.3

EBS ONE CHANNEL MODULE

R17.02.2000 (MERCEDES)	
Alternative Part No	EA2000 1I37083N50
Repair Kit	EKKB.49.5

TEBS 4 TRAILER CONTROL MODULE - KNORR BREMSE

R17.02.2053		
Alternative Part No	ES2041 ES2050 ES2053	1I39782 1I39783 1I39798
Repair Kit	EKKB.58.1	

EBS SYSTEM PACKAGE - KNORR BREMSE

EBSTEBSA		
Alternative Part No	---	
System	TEBS Retrofit Kit 2S/2M Upgrade ABS to EBS	
Repair Kit	---	

EBS TRAILER CONTROL MODULE - GENERATION 2 - KNORR BREMSE

K019312V04N50		K019342V02N00		K019349V02N50		K019350V02	
							
Alternative Part No	ES2060 K019309V04 K019312V04 K019319B90 K019319V04	Alternative Part No	---	Alternative Part No	K019340	Alternative Part No	---
System	Covers All G2 & G2.1 Systems	System	G2 2S/2M c/w With Fittings	System	G2 2S/2M No Fittings	System	G2.1 No Fittings
Repair Kit	EKKB.58.2	Repair Kit	EKKB.58.2	Repair Kit	EKKB.58.2	Repair Kit	EKKB.58.2
K019350V02		K055369B90					
							
Alternative Part No	---	Alternative Part No	ES2090 K055342V01N49 K055352V00N49				
System	G2.1 c/w With Fittings	System	G2.2				
Repair Kit	EKKB.58.2	Repair Kit	EKKB.58.2				

ABS & EBS

EBS EB+ ECU - HALDEX

---		---		---		---	
							
Alternative Part No	950800201	Alternative Part No	950800202	Alternative Part No	950800203	Alternative Part No	950800204
System	EBS EB+ 5 Aux 2/4 Sensors Colas Compatible	System	EBS EB+ 5 Aux 4 Sensors Colas Compatible	System	EBS EB+ 5 Aux 4 Sensors Colas Compatible	System	EBS EB+ 5 Aux c/w RSP Function 4 Sensors Colas Compatible
Repair Kit	---	Repair Kit	---	Repair Kit	---	Repair Kit	---

EBS EB+ EPRV MODULATOR VALVES - HALDEX

---		---		---		---	
Alternative Part No	950800302	Alternative Part No	950800303	Alternative Part No	950800304	Alternative Part No	950800305
System	EBS EB+ 2M SYSTEM. DOUBLE TYPE. 6 DELIVERY PORTS.	System	EBS EB+ 1M SYSTEM. SINGLE TYPE. 6 DELIVERY PORTS.	System	EBS EB+ 1M SYSTEM. SINGLE TYPE. 6 DELIVERY PORTS.	System	EBS EB+ 2M SYSTEM. DOUBLE TYPE. 6 DELIVERY PORTS.
Repair Kit	---	Repair Kit	---	Repair Kit	---	Repair Kit	---

HALDEX EBS EB+ GENERATION 2 - HALDEX

---		---	
Alternative Part No	950800306	Alternative Part No	820007001 820008001 820019001
System	EBS EB+ 1M SYSTEM. SINGLE TYPE. 6 DELIVERY PORTS.	System	EBS EB+ GEN 2 5 Aux c/w RSP Function & Super Aux 2M - 2/4 Sensors c/w QRV & DCV
Repair Kit	---	Repair Kit	---

EBS EB+ GENERATION 3 - HALDEX

950823008		950823008K	
Alternative Part No	820007001 820008001 820019001	Alternative Part No	950823008
System	EBS EB+ GEN 3 5 Aux c/w RSP Function & Super Aux 2M - 2/4 Sensors c/w QRV & DCV	System	EBS EB+ GEN 3 5 Aux c/w RSP Function & Super Aux 2M - 2/4 Sensors c/w QRV & DCV
Repair Kit	EKGH.591	Repair Kit	---

EBS AXLE MODULATOR - 1st GENERATION - WABCO

	R17.01.4011		R17.01.4012	R17.01.4015	R17.01.4018	R17.01.4022	R17.01.4024
	Alternative Part No	4801030110	4801030120	4801030150	4801030160	4801030220	4801030240
	System	Mercedes 4x2 (1999>)	Mercedes 6x2 6x2/4 6x4 8x4 (1999 - 2003)	Mercedes Actros 2 4x2 (2001>)	Mercedes All except 4x2	Iveco (1998 - 2004)	Iveco (2000>)
	Repair Kit	EKWA.32.1 and EKWA.32.1A	EKWA.32.1 and EKWA.32.1A	EKWA.32.1 and EKWA.32.1A	EKWA.32.1 and EKWA.32.1A	EKWA.32.1 and EKWA.32.1A	EKWA.32.1 and EKWA.32.1A

	R17.01.4041		R17.01.4042	R17.01.4043	R17.01.4061	R17.01.4063
	Alternative Part No	4801030410	4801030420	4801030430	4801030610	4801030630
	System	DAF FA 4x2 (04/2001 - 10/2003)	DAF FAG / FTG 6x2 (04/2001 - 10/2003)	DAF FT 4x2 (04/2001 - 10/2003)	MERCEDES	MERCEDES
	Repair Kit	EKWA.32.1 and EKWA.32.1A	EKWA.32.1 and EKWA.32.1A	EKWA.32.1 and EKWA.32.1A	EKWA.32.1 and EKWA.32.1A	EKWA.32.1 and EKWA.32.1A

EBS AXLE MODULATOR - 2nd GENERATION - WABCO

R17.01.5001		R17.01.5002		R17.01.5003		R17.01.5005	
							
Alternative Part No	4801040010	Alternative Part No	4801040020	Alternative Part No	4801040030	Alternative Part No	4801040050
System	DAF 4x2 (10/2003>)	System	DAF 6x2 (10/2003>)	System	DAF FT 4x2 (10/2003>)	System	Iveco Stralis (2004)
Repair Kit	EKWA.32.104 OR EKWA.32.104.C	Repair Kit	EKWA.32.104 OR EKWA.32.104.C	Repair Kit	EKWA.32.104 OR EKWA.32.104.C	Repair Kit	EKWA.32.104 OR EKWA.32.104.C

R17.01.5006		R17.01.5107		R17.01.5106		R17.01.5009	
							
Alternative Part No	4801040060	Alternative Part No	4801041050 4801041070	Alternative Part No	4801041060	Alternative Part No	4801040090
System	Iveco Stralis (2004)	System	MAN Neoplan (2005)	System	MAN	System	MAN
Repair Kit	EKWA.32.104 OR EKWA.32.104.C	Repair Kit	EKWA.32.104 OR EKWA.32.104.C	Repair Kit	EKWA.32.104 OR EKWA.32.104.C	Repair Kit	EKWA.32.104 OR EKWA.32.104.C

ABS & EBS

**EBS AXLE MODULATOR
- 3rd GENERATION - WABCO**

R17.01.6006		R17.01.6007	
Alternative Part No	4801050060	Alternative Part No	4801050070
System	MERCEDES	System	MERCEDES
Repair Kit	EKWA.32.105	Repair Kit	EKWA.32.105

**EBS TRAILER MODULATOR
- GENERATION D - WABCO**

R17.01.3014		---	
Alternative Part No	480102014R 4801020100 4801020140	Alternative Part No	4801020200
System	EBS-D/RSS 4S/3M Wabco Remanufactured	System	EBS-D 4S/2M 12V
Repair Kit	EKWA.58.12	Repair Kit	EKWA.58.12

EBS TRAILER MODULATOR - GENERATION E - WABCO

---		R17.01.3031		---		R17.01.3033	
Alternative Part No	4801020300	Alternative Part No	4801020310	Alternative Part No	4801020320	Alternative Part No	4801020330
System	EBS-E (Universal Std) 2S/2M Without Fittings Without PEM Supply = M22	System	EBS-E (Standard) 2S/2M With PEM With Fittings Supply = Pipe 16x2	System	EBS-E (Standard) 2S/2M Without PEM With Fittings Supply = Pipe 15x1.5	System	EBS-E (Standard) 2S/2M With PEM With Fittings Supply = Pipe 15x1.5
Repair Kit	EKWA.32.102	Repair Kit	4615130020 and EKWA.32.102	Repair Kit	EKWA.32.102	Repair Kit	EKWA.32.102
R17.01.3034		---		---		---	
Alternative Part No	4801020340	Alternative Part No	4801020350	Alternative Part No	4801020360	Alternative Part No	4801020600
System	EBS-E (Standard) 2S/2M With PEM Without Fittings	System	EBS-E (Standard) 2S/2M With PEM With Fittings Supply = Pipe 15x1.5	System	EBS-E (Standard) 2S/2M With PEM With Fittings Supply = Pipe 15x1.5	System	EBS-E (Universal Premium) 4S/3M Without PEM Without Fittings Supply = M22
Repair Kit	4615130020 and EKWA.32.102	Repair Kit	4615130020 and EKWA.32.102	Repair Kit	4615130020 and EKWA.32.102	Repair Kit	EKWA.32.102

EBS TRAILER MODULATOR - GENERATION E - WABCO

---		---		---		R17.01.3064	
							
Alternative Part No	4801020610	Alternative Part No	4801020620	Alternative Part No	4801020630	Alternative Part No	4801020640
System	EBS-E (Premium) 4S/3M With PEM With Fittings Supply = Pipe 16x2	System	EBS-E (Premium) 4S/3M Without PEM With Fittings Supply = Pipe 15x1.5	System	EBS-E (Premium) 4S/3M With PEM With Fittings Supply = Pipe 15x1.5	System	EBS-E (Premium) 4S/3M With PEM Without Fittings
Repair Kit	EKWA.32.102	Repair Kit	EKWA.32.102	Repair Kit	4615130020 and EKWA.32.102	Repair Kit	4615130020 and EKWA.32.102

---		---		---		---	
							
Alternative Part No	4801020650	Alternative Part No	4801020660	Alternative Part No	4801020800	Alternative Part No	4615130000
System	EBS-E (Premium) 4S/3M With PEM With Fittings Supply = Pipe 15x1.5	System	EBS-E (Premium) 4S/3M With PEM With Fittings Supply = Pipe 15x1.5	System	EBS-E (Premium) 2S/2M - 4S/3M Without PEM Without fittings Supply = M 22x 1.5	System	EBS-E (Premium) 2S/2M - 4S/3M With fittings Supply = M 22x 1.5
Repair Kit	4615130020 and EKWA.32.102	Repair Kit	4615130020 and EKWA.32.102	Repair Kit	EKWA.32.102	Repair Kit	EKWA.32.102

	
Alternative Part No	4615130020
System	EBS-E (Premium) 2S/2M - 4S/3M without fittings Supply = M 22x 1.5
Repair Kit	---

ABS & EBS

AUXILLIARY CABLES - HALDEX

Alternative Part No	950800431	Alternative Part No	950800433	Alternative Part No	950800434	Alternative Part No	950800481
EBS EB+ CANBUS Length = 7M		EBS EB+ CANBUS Length = 2M		EBS EB+ CANBUS Length = 4M		EBS EB+ COLAS / ILAS Length = 7M	
Alternative Part No	950800483	Alternative Part No	950800484				
EBS EB+ COLAS / ILAS Length = 1M		EBS EB+ COLAS / ILAS Length = 2M					

DIAGNOSTIC / INFO CENTRE CABLES - HALDEX

Alternative Part No	003846709	Alternative Part No	003863709	Alternative Part No	364377001	Alternative Part No	814001601
ABS Modular To Info Centre Length = 2M		ABS Modal Diagnostic Length = 1.3M		ABS Modal To Info Centre Length = 6M		EBS EB+ Diagnostic from ECU To PC Length = 6.5M	
Alternative Part No	814001621	Alternative Part No	814010101	Alternative Part No	814011001	Alternative Part No	814019001
EBS EB+ Diagnostic from ECU To PC Length = 20M		EBS EB+ To Info Centre Length = 6.5M		EBS EB+ Diagnostic from ECU To PC Length = 6.5M		EBS EB+ To Info Centre 2 (ADR) Length = 6.5M	

DIAGNOSTIC / INFO CENTRE CABLES - HALDEX

							
Alternative Part No	814019011	Alternative Part No	814036001	Alternative Part No	814036011	Alternative Part No	814036021
EBS EB+ To Info Centre 2 Length = 0.5M		EBS EB+ Gen 3 Diagnostic from ECU To PC Length = 6.5M		EBS EB+ Gen 3 Diagnostic from ECU To PC Length = 15M		EBS EB+ Gen 3 Diagnostic from ECU To PC Length = 20M	
							
Alternative Part No	814037001	Alternative Part No	950800462	Alternative Part No	950800463		
EBS EB+ To Info Centre 2 (ADR) Length = 6.5M		EBS EB+ To DIAG+ /Info Centre Length = 2.5M		EBS EB+ To DIAG+ /Info Centre Length = 5M			

LINK CABLES - HALDEX EBS

							
Alternative Part No	950800471	Alternative Part No	950800472	Alternative Part No	950800474	Alternative Part No	950800475
EBS EB+ Length = 12M		EBS EB+ Length = 2M		EBS EB+ Length = 14M		EBS EB+ Length = 10M	
							
Alternative Part No	950800476						
EBS EB+ Length = 8M							

LOOMS - ABS - HALDEX

---		---		---		---		---	
									
Alternative Part No	364338011	Alternative Part No	364344001	Alternative Part No	364338011	Alternative Part No	950364418	Alternative Part No	950364419
ABS Modular 2 2S/2M 2 x Sensor Colas Cable - 6M 28 Pin Can Use 950364419		ABS Modular 2 2S/2M 2 x Sensor Colas Cable - 6M 28 Pin Can Use 950364419		ABS Modular 1 Upgrade 2S/1M 2 x Sensor Colas Cable - w/o 19 Pin		ABS Modular 1 Plus 2S/1M 2 x Sensor Colas Cable - 7M 28 Pin		ABS Modular 2 4S/2M 4 x Sensor Colas Cable - 7M 28 Pin	

POWER CABLES - ABS - HALDEX

---		---		---		---		---	
									
Alternative Part No	364357001	Alternative Part No	364358001	Alternative Part No	364352021	Alternative Part No	364364031	Alternative Part No	364352021
ABS Modular ISO7638 Length = 12M		ABS Modular 2 ISO1185 Length = 12M		ABS Modular ISO7638 Length = 14M		ABS Modular ISO7638 Length = 16M		ABS Modal ISO7638 Length = 12M	
---		---		---		---		---	
									
Alternative Part No	950364404	Alternative Part No	950364405	Alternative Part No	950364407	Alternative Part No	950364421	Alternative Part No	950364422
ABS Modular ISO7638 Length = 12M		ABS Modular 2 ISO1185 Length = 12M		ABS Modal ISO1185 Length = 12M		ABS Modular ISO7638 Length = 12M		ABS Modular ISO7638 Length = 12M	
---		---		---		---		---	
									
Alternative Part No	950364425	Alternative Part No	950364426	Alternative Part No	950364429	Alternative Part No	814002242	Alternative Part No	950800401
ABS Modular 1 ISO1185 Length = 12M		ABS Modular 2 ISO1185 Length = 12M		ABS Modular ISO7638 Length = 12M		EBS EB+ ISO1185 Length = 9M		EBS EB+Blue ISO7638 Length = 12M	

POWER CABLES - ABS - HALDEX

---		---		---		---		---	
									
Alternative Part No	950800402	Alternative Part No	950800403	Alternative Part No	950800404	Alternative Part No	950800405	Alternative Part No	950800406
EBS EB+ Blue ISO7638 Length = 12M		EBS EB+ Blue ISO7638 Length = 18M		EBS EB+ Blue ISO7638 Length = 9M		EBS EB+ Blue ISO7638 Length = 14M		EBS EB+ Blue ISO7638 Length = 6M	
---		---		---		---		---	
									
Alternative Part No	950800411	Alternative Part No	950800412	Alternative Part No	950800421	Alternative Part No	950800422	Alternative Part No	950800424
EBS EB+ Blue ISO7638 Length = 9M		EBS EB+ Blue ISO7638 Length = 12M		EBS EB+ Yellow ISO1185 Length = 12M		EBS EB+ Yellow ISO1185 Length = 6M		EBS EB+ Yellow ISO1185 Length = 4M	
---		---		---		---		---	
				---		---		---	
Alternative Part No	814003102	Alternative Part No	814003142	---		---		---	
EBS EB+ Blue ISO7638 Length = 12M		EB+ ISO 7638 Length = 14M		---		---		---	

PRESSURE SWITCH CABLES - EBS - HALDEX

---		---		---	
					
Alternative Part No	950800451	Alternative Part No	950800452	Alternative Part No	950800453
EBS EB+ Length = 10M		EBS EB+ Length = 2M		EBS EB+ Length = 0.75M	

ABS & EBS

PRESSURE SWITCH CABLES - EBS - HALDEX

Alternative Part No	950800454
EBS EB+ Length = 3M	

Alternative Part No	950800455
EBS EB+ Length = 5M	

Alternative Part No	950800456
EBS EB+ Length = 8M	

AUXILIARY CABLES - KNORR BREMSE

Alternative Part No	K002274
TEBS G2/2.1 & TEBS 4 Auxiliary Connecting Cable - 2 Pins Length = 2M	

Alternative Part No	K002275
TEBS G2/2.1 & TEBS 4 Auxiliary Connecting Cable - 2 Pins Length = 6.5M	

Alternative Part No	K002276N00
TEBS G2/2.1 & TEBS 4 Auxiliary Connecting Cable - 2 Pins Length = 10M	

Alternative Part No	K02277N00
TEBS G2/2.1 & TEBS 4 Auxiliary Connecting Cable - 3 Pins Length = 10M	

Alternative Part No	K002280
TEBS G2/2.1 & TEBS 4 Auxiliary Connecting Cable - 2 Pins 2 Open Ends Length = 7M	

Alternative Part No	K002281
TEBS G2/2.1 & TEBS 4 Auxiliary Connecting Cable - 2 Pins 2 Open Ends Length = 15M	

CONNECTING CABLES - KNORR BREMSE

Alternative Part No	1135417500 EK3013
For Modulator Connection M24 x 1 Length = 0.5M	

DIAGNOSTIC CABLES - KNORR BREMSE

Alternative Part No	11354183000 EK3050
Length = 3M	

Alternative Part No	K006096N00
Trailer Diagnostics Length = 0.5M	

POWER CABLES - KNORR BREMSE

	Alternative Part No II367395 EK3100	TEBS 4 Power Supply Harness ISO7638 & ISO1185 c/w Diagnostic Socket Power Cable = 0.5M Diagnostic Cable = 4M
	Alternative Part No II367397 EK3100	TEBS 4 Power Supply Harness ISO7638 & ISO1185 c/w Diagnostic Socket Power Cable = 0.5M Diagnostic Cable = 6M
	Alternative Part No II3674112000 EK3110	TEBS 4 Power Supply Cable ISO7638 Length = 12M
	Alternative Part No II3674115000 EK3110	TEBS 4 Power Supply Cable ISO7638 Length = 15M
	Alternative Part No II40391F2 EK3108	TEBS 4 Power Supply Harness ISO7638 & ISO1185 Power Cable = 0.5M Stop Lamp Cable = 12M
	Alternative Part No K008431N00	TEBS G2 Power Supply Cable ISO7638 Length = 13M

DIAGNOSTIC CABLES - WABCO

	Alternative Part No 4463003292	VCS/ECAS/VARIO C TRAILER EBS 7 Pin Length = 6M
	Alternative Part No 4496120100	VCS Length = 1M
	Alternative Part No 4496120300	VCS Length = 3M
	Alternative Part No 4496141530	TEBS Cable 1 = 6M Cable 2 = 3M
	Alternative Part No 4496142530	TEBS Cable 1 = 6M Cable 2 = 6M
	Alternative Part No 4496150300	VCS 2 Length = 3M
	Alternative Part No 4496161560	VCS 2 Diagnosis & A-modulator cable Cable 1 = 3M Cable 2 = 10M
	Alternative Part No 4496162530	VCS 2 Diagnosis & A-modulator cable Cable 1 = 6M Cable 2 = 6M

ABS & EBS

DIAGNOSTIC CABLES - WABCO

Alternative Part No	4496172530	Alternative Part No	4496172570	Alternative Part No	4496241130	Alternative Part No	4496641900
VCS 2 Cable 1 = 6M Cable 2 = 6M		VCS 2 Cable 1 = 6M Cable 2 = 12M		TEBS Diagnostic & ILS Cable 1 = 6M Cable 2 = 2M		TEBS Diagnostic & Lift Axle Cable 1 = 4M Cable 2 = 4M	
Alternative Part No	4496642530	Alternative Part No	4496720300	Alternative Part No	4496720400	Alternative Part No	4496720600
TEBS Diagnostic & Lift Axle Cable 1 = 6M Cable 2 = 6M		TEBS Length = 3M		TEBS Length = 4M		TEBS Length = 6M	
Alternative Part No	4496720800	Alternative Part No	4496843130				
TEBS Length = 8M		TEBS Diagnostic & Stop Light Cable 1 = 6M Cable 2 = 10M					

POWER SUPPLY CABLES - WABCO

						30.72.1200 	
Alternative Part No	4491121200	Alternative Part No	4491243370	Alternative Part No	4491421200	Alternative Part No	4491721200
VCS Length = 12M		VCS 2 ISO 7638 & 24 N Length = 12M		VARIO C / Truck Length = 12M		Power = ISO 24V Length = 12M	

POWER SUPPLY CABLES - WABCO

<p>30.72.1300</p>  <p>Alternative Part No 4497121300</p> <p>Power = ISO 24V Length = 13M</p>	<p>30.72.1500</p>  <p>Alternative Part No 4491721500</p> <p>Power = ISO 24V Length = 15M</p>	<p>30.73.0900</p>  <p>Alternative Part No 4491730900</p> <p>EBS-E ISO7638 Length = 9M</p>	<p>30.73.1000</p>  <p>Alternative Part No 4491731000</p> <p>EBS-E ISO7638 Length = 10M</p>
<p>30.73.1200</p>  <p>Alternative Part No 4491731200</p> <p>EBS-E ISO7638 Length = 12M</p>	<p>30.73.1300</p>  <p>Alternative Part No 4491731300</p> <p>EBS-E ISO7638 Length = 13M</p>	<p>30.73.1400</p>  <p>Alternative Part No 4491731400</p> <p>EBS-E ISO7638 Length = 14M</p>	<p>30.73.1500</p>  <p>Alternative Part No 4491731500</p> <p>EBS-E ISO7638 Length = 15M</p>
<p>---</p>  <p>Alternative Part No 4492121200</p> <p>VCS Drawbar Trailers Length = 12M</p>	<p>---</p>  <p>Alternative Part No 4492251000</p> <p>VCS Drawbar Trailers ISO 7638 Length = 10M</p>	<p>---</p>  <p>Alternative Part No 4492721200</p> <p>EBS Drawbar Trailers Length = 12M</p>	<p>---</p>  <p>Alternative Part No 4493142570</p> <p>VCS Power Supply & Diagnostic Cable 1 = 12M Cable 2 = 6M</p>
<p>---</p>  <p>Alternative Part No 4493321200</p> <p>VCS Without ISO Plug Length = 12M</p>	<p>---</p>  <p>Alternative Part No 4493330030</p> <p>TEBS Length = 0.3M</p>	<p>---</p>  <p>Alternative Part No 4493743230</p> <p>VCS 2 Cable 1 = 1M Cable 2 = 12M</p>	<p>---</p>  <p>Alternative Part No 4493861430</p> <p>VCS 2 7 Wire Y Power Cable & Diagnostic Cable Cable 1 = 1M Cable 2 = 3M</p>
<p>---</p>  <p>Alternative Part No 4494021200</p> <p>VCS Connecting Cable Length = 12M</p>			

CONNECTING CABLES - WABCO

	Alternative Part No 4493491000	Trailer EBS-E Stop Light Supply ISO 1185 Length = 10M
	Alternative Part No 4493720300	Trailer EBS For Relay Valve Connection Length = 3M
	Alternative Part No 4493720600	Trailer EBS For Relay Valve Connection Length = 6M
	Alternative Part No 4494440220	VCS For ABS Modulator Connection Cable 1 = 0.4M Cable 2 = 0.4M
	Alternative Part No 4494441900	VCS For ABS Modulator Connection Cable 1 = 4M Cable 2 = 4M
	Alternative Part No 4494442510	VCS For ABS Modulator Connection Cable 1 = 6M Cable 2 = 4.5M
	Alternative Part No 4497230230	EBS-E 2 Pin ABS Socket Length = 2.3M
	Alternative Part No 4497230300	EBS-E 2 Pin ABS Socket Length = 3M
	Alternative Part No 4497230800	EBS-E 2 Pin ABS Socket Length = 8M
	Alternative Part No 4497520300	TEBS Pressure Sensor Connection Length = 3M
	Alternative Part No 8946010112	VARIO C ABS Modulator Connection Length = 4M
	Alternative Part No 8946010142	VARIO C ABS Modulator Connection Length = 9M

PRESSURE SENSORS

EBS Part No	Alternative	Information	Image
---	950800903	Haldex EBS EB+	
---	950800907		
EKWA.32.S1	4422707002	Pressure Sensor to suit 480 105 series	

SENSOR EXTENSION CABLES

EBS Part No	Alternative	Information	Image
17.03.9401	814004401	Extension Cable LENGTH = 3M	
17.03.9411	814004411	Extension Cable LENGTH = 6M	

EBS BOSCH REPAIR KITS

<p>EKBO.58.1</p>	<p>EKBO.58.2</p>	<p>EKBO.58.3</p>	
<p>EKBO.58CAP.A</p>	<p>EKBO.58CAP.B</p>	<p>EKBO.58CAP.C</p>	<p>SEAL-2 (Soft Kit)</p>

EBS HALDEX REPAIR KITS

<p>950364021</p>	<p>950364061</p>	<p>950364108</p>	<p>EKGH.2.1A</p>
<p>EKGH.2.1C</p>	<p>EKGH.57.2</p>	<p>EKGH.57.6</p>	
<p>EKGH.57.FK</p>	<p>EKGH.59.1</p>	<p>EKGH.110.1</p>	

ABS & EBS

EBS KNORR BREMSE REPAIR KITS

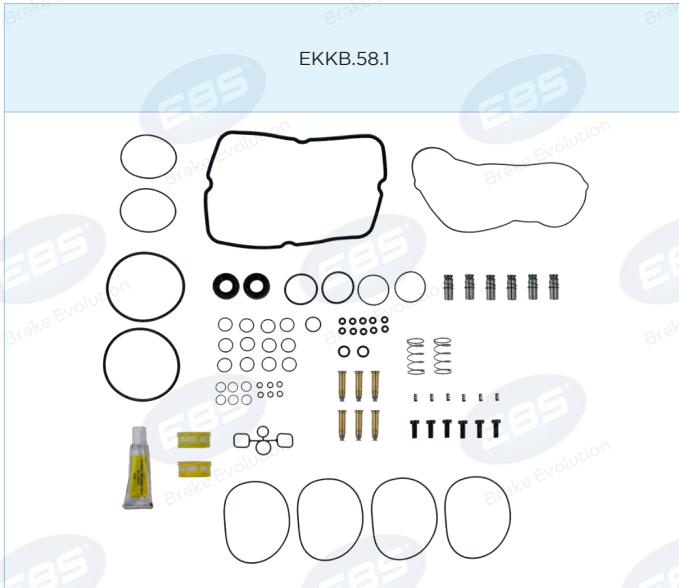

EBS WABCO REPAIR KITS

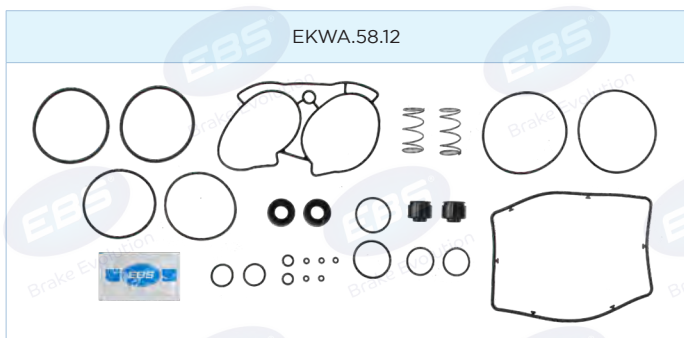
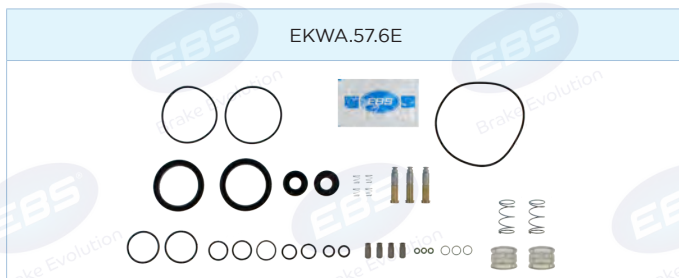
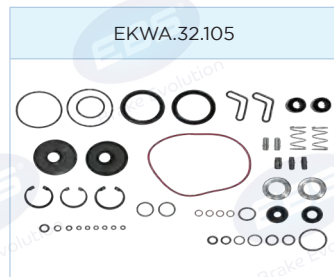
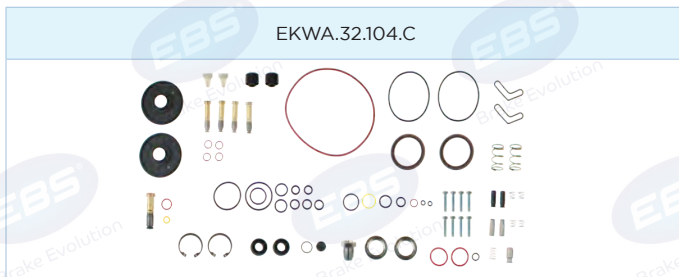

ABS & EBS

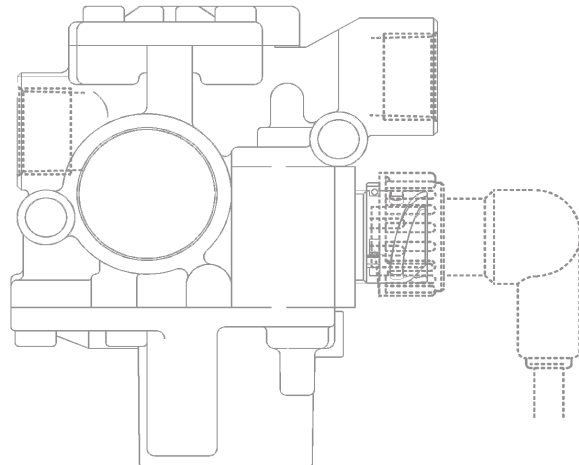
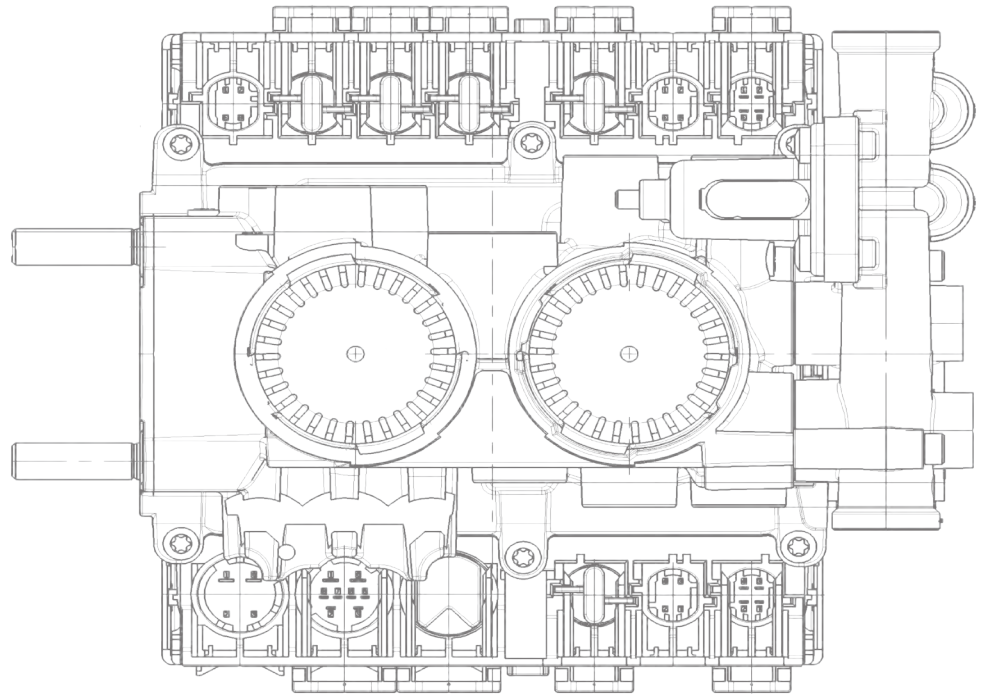
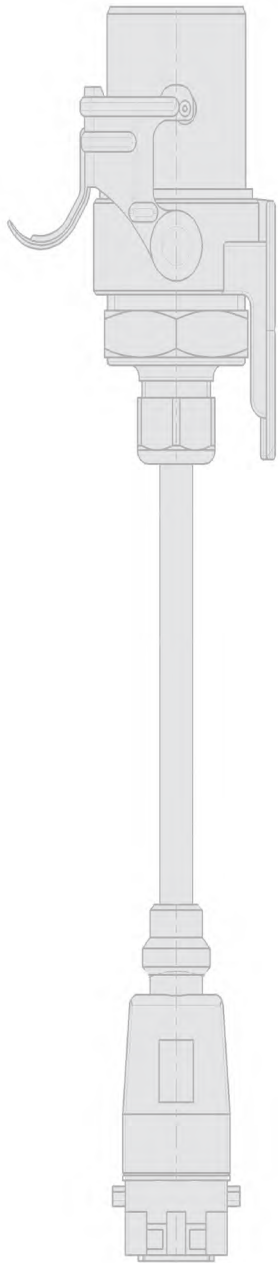

MULTI CIRCUIT PROTECTION VALVES (MCPV)

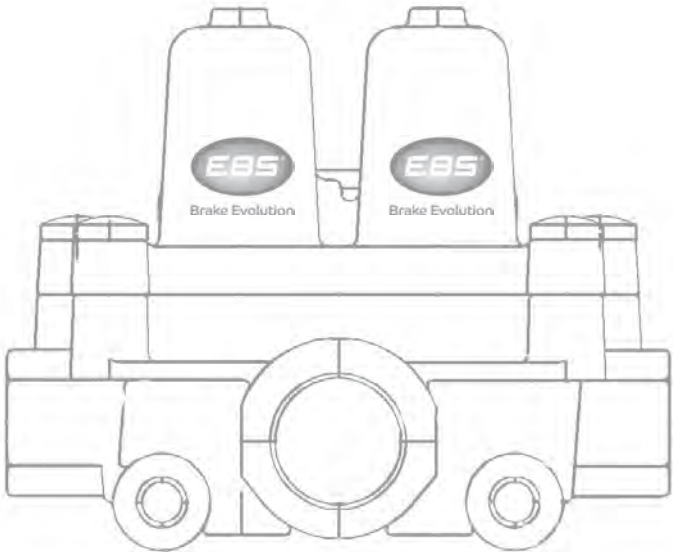
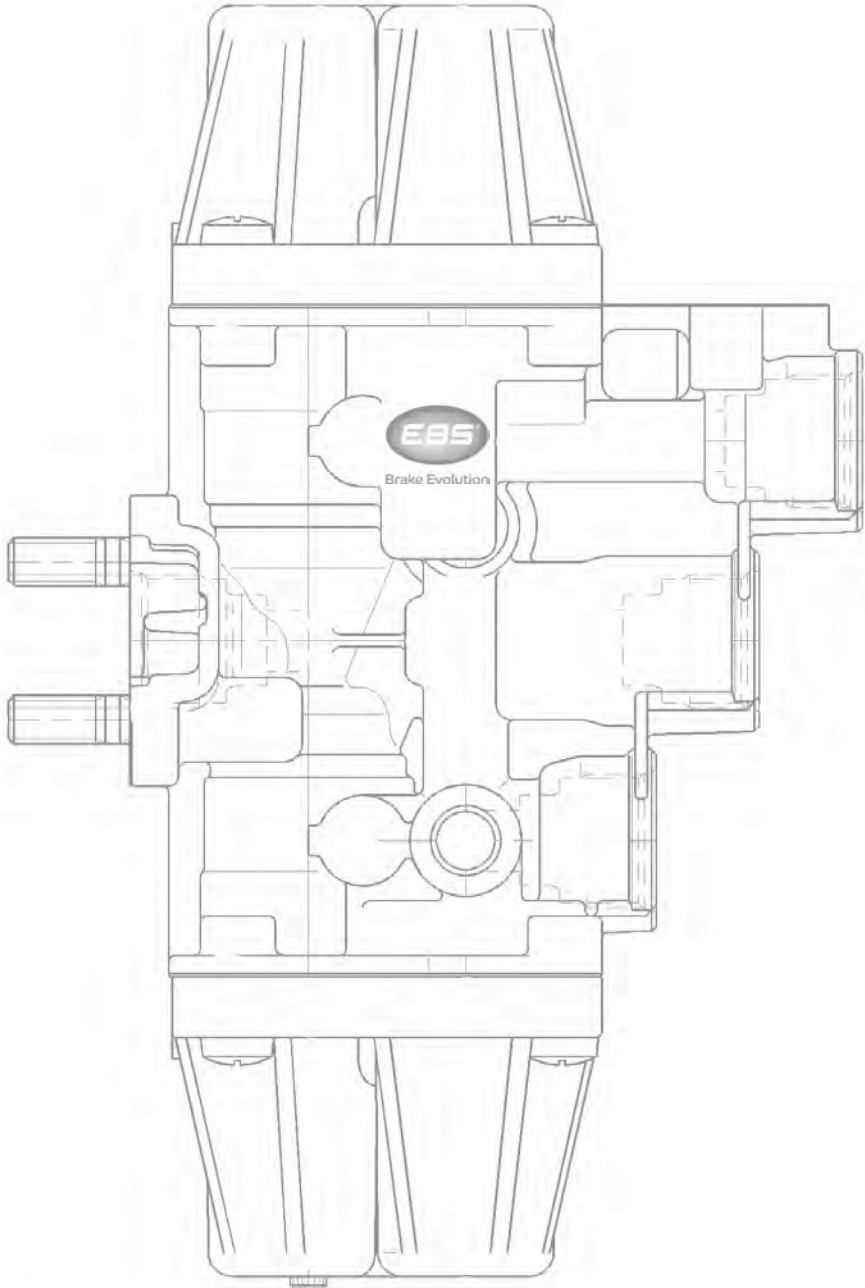

MULTI CIRCUIT PROTECTION VALVES - BOSCH

---		18.01.1210		18.04.1000			
Alternative Part No	0481062005 0481062006	Alternative Part No	0481062104				
Repair Kit	EKBO.8.1	Repair Kit	EKBO.8.1				
---		---					
Alternative Part No	0481062209 0481062413	Alternative Part No	0481062109 0481062110	Alternative Part No		0481062105 0481062107 0481062201 0481062301 0481062303 0481062307 0481062308	
Repair Kit	EKBO.8.1	Repair Kit	EKBO.8.1	Repair Kit		EKBO.8.1	
				Alternative Part No		0481062309 0481062310 0481062312 0481062317 0481062401 0481062405 0481062412	

MULTI CIRCUIT PROTECTION VALVES - HALDEX

18.03.1000	
Alternative Part No	314059001 314060001
Repair Kit	EKGH.51.3

MULTI CIRCUIT PROTECTION VALVES - HINO

18.37.1000	
Alternative Part No	S4457-01330
Repair Kit	---

MULTI CIRCUIT PROTECTION VALVES - KNORR BREMSE

18.02.1158		18.02.1162		18.02.1168		18.02.1170	
Alternative Part No	AE4158	Alternative Part No	AE4162	Alternative Part No	AE4168	Alternative Part No	AE4170
Repair Kit	EKKB.3.3	Repair Kit	EKKB.3.3	Repair Kit	EKKB.3.3	Repair Kit	EKKB.3.3

MULTI CIRCUIT PROTECTION VALVES - KNORR BREMSE

18.02.1171		18.02.1178		18.02.1179		18.02.1183	
							
Alternative Part No	AE4171	Alternative Part No	AE4178	Alternative Part No	AE4179	Alternative Part No	AE4183 179379
Repair Kit	EKKB.3.3	Repair Kit	EKKB.3.3	Repair Kit	EKKB.3.3	Repair Kit	EKKB.3.3
18.02.1186		18.02.1188		18.02.1190		18.02.1191	
							
Alternative Part No	AE4186	Alternative Part No	AE4188	Alternative Part No	AE4190	Alternative Part No	AE4191
Repair Kit	EKKB.3.3	Repair Kit	EKKB.3.3	Repair Kit	EKKB.3.3	Repair Kit	EKKB.3.3
18.02.1196		18.02.1404		18.02.1405		18.02.1407	
							
Alternative Part No	AE4196	Alternative Part No	AE4404	Alternative Part No	AE4405	Alternative Part No	AE4407
Repair Kit	EKKB.3.3	Repair Kit	EKKB.3.3	Repair Kit	EKKB.3.3	Repair Kit	EKKB.3.3
18.02.1408		18.02.1409		18.02.1427		18.02.1428	
							
Alternative Part No	AE4408	Alternative Part No	AE4409	Alternative Part No	AE4427	Alternative Part No	AE4428
Repair Kit	EKKB.3.3	Repair Kit	EKKB.3.3	Repair Kit	EKKB.3.3	Repair Kit	EKKB.3.3
18.02.1437		18.02.1440		18.02.1447		18.02.1448	
							
Alternative Part No	AE4437	Alternative Part No	AE4440	Alternative Part No	AE4447	Alternative Part No	AE4448
Repair Kit	EKKB.3.3	Repair Kit	EKKB.3.3	Repair Kit	EKKB.3.3	Repair Kit	EKKB.3.3

MULTI CIRCUIT PROTECTION VALVES (MCPV)

MULTI CIRCUIT PROTECTION VALVES - KNORR BREMSE

18.02.1449		18.02.1452		18.02.1502		18.02.1503	
Alternative Part No	AE4449	Alternative Part No	AE4452	Alternative Part No	AE4502	Alternative Part No	AE4503
Repair Kit	EKKB.3.3	Repair Kit	EKKB.3.3	Repair Kit	EKKB.80	Repair Kit	EKKB.80
Sensor	No Sensor	Sensor	No Sensor	Sensor	No Sensor	Sensor	No Sensor
18.02.1505		18.02.1506		18.02.1510		18.02.1516	
Alternative Part No	AE4505	Alternative Part No	AE4506	Alternative Part No	AE4510	Alternative Part No	AE4516
Repair Kit	EKKB.80	Repair Kit	EKKB.80	Repair Kit	EKKB.80	Repair Kit	EKKB.80
Sensor	No Sensor	Sensor	No Sensor	Sensor	EKKB.80.1 (5 Volt)	Sensor	EKKB.80.1 (5 Volt)
18.02.1525		18.02.1526		18.02.1527		18.02.1528 R18.02.1528	
Alternative Part No	AE4525	Alternative Part No	AE4526	Alternative Part No	AE4527	Alternative Part No	AE4528
Repair Kit	EKKB.80	Repair Kit	EKKB.80	Repair Kit	EKKB.80	Repair Kit	EKKB.80
Sensor	No Sensor	Sensor	EKKB.80.1 (5 Volt)	Sensor	EKKB.80.1 (5 Volt)	Sensor	EKKB.80.1 (5 Volt)
18.02.1529		18.02.1534		18.02.1535		18.02.1560	
Alternative Part No	AE4529	Alternative Part No	AE4534	Alternative Part No	AE4535	Alternative Part No	AE4560
Repair Kit	EKKB.80	Repair Kit	EKKB.80	Repair Kit	EKKB.80	Repair Kit	EKKB.82
Sensor	EKKB.80.1 (5 Volt)	Sensor	EKKB.80.1 (5 Volt)	Sensor	EKKB.80.1 (5 Volt)	Sensor	EKKB.80.1 (5 Volt)

MULTI CIRCUIT PROTECTION VALVES - KNORR BREMSE

	
Alternative Part No	AE4561
Repair Kit	EKKB.82
Sensor	EKKB.80.1 (5 Volt)

18.02.1603	
	
Alternative Part No	AE4603
Repair Kit	EKKB.3.4 EKKB.3.6

18.02.1604	
	
Alternative Part No	AE4604
Repair Kit	EKKB.3.4 EKKB.3.6

18.02.1605	
	
Alternative Part No	AE4605
Repair Kit	EKKB.3.4 EKKB.3.6

18.02.1608	
	
Alternative Part No	AE4608
Repair Kit	EKKB.3.4 EKKB.3.6

18.02.1609	
	
Alternative Part No	AE4609
Repair Kit	EKKB.3.4 EKKB.3.6

18.02.1610	
	
Alternative Part No	AE4610
Repair Kit	EKKB.3.4 EKKB.3.6

18.02.1611	
	
Alternative Part No	AE4611
Repair Kit	EKKB.3.4 EKKB.3.6

18.02.1612	
	
Alternative Part No	AE4612
Repair Kit	EKKB.3.4 EKKB.3.6

18.02.1613	
	
Alternative Part No	AE4613
Repair Kit	EKKB.3.4 EKKB.3.6

18.02.1615	
	
Alternative Part No	AE4615
Repair Kit	EKKB.3.4 EKKB.3.6

18.02.1616	
	
Alternative Part No	AE4616
Repair Kit	EKKB.3.4 EKKB.3.6

18.02.1620	
	
Alternative Part No	AE4620
Repair Kit	EKKB.3.4 EKKB.3.6







18.02.1623	
	
Alternative Part No	AE4623
Repair Kit	EKKB.3.4

18.02.1625	
	
Alternative Part No	AE4625
Repair Kit	EKKB.3.4



18.02.1642	
	
Alternative Part No	AE4642
Repair Kit	EKKB.3.4 EKKB.3.6

MULTI CIRCUIT PROTECTION VALVES (MCPV)

MULTI CIRCUIT PROTECTION VALVES - KNORR BREMSE

18.02.1643		18.02.1644		18.02.1645		18.02.1646	
							
Alternative Part No	AE4643	Alternative Part No	AE4644	Alternative Part No	AE4645	Alternative Part No	AE4646
Repair Kit	EKKB.3.4 EKKB.3.6	Repair Kit	EKKB.3.4	Repair Kit	EKKB.3.4 EKKB.3.6	Repair Kit	EKKB.3.4 EKKB.3.6
18.02.1648		18.02.1653		18.02.1654		18.02.1658	
							
Alternative Part No	AE4648	Alternative Part No	AE4653 K023347	Alternative Part No	AE4654 K023348	Alternative Part No	AE4658 K023352
Repair Kit	EKKB.3.4 EKKB.3.6	Repair Kit	EKKB.3.4	Repair Kit	EKKB.3.4 EKKB.3.6	Repair Kit	EKKB.3.4
18.02.1800		R18.02.6000					
							
Alternative Part No	AE4800	Alternative Part No	AE6000 K075170N50				
Repair Kit	EKKB.81 EKKB.80.1	Repair Kit	EKKB.83				

MULTI CIRCUIT PROTECTION VALVES - MAGNETI MARELLI

18.02.1158		18.02.1407		18.02.2001		18.02.2002	
							
Alternative Part No	VPS40C	Alternative Part No	VPS41A	Alternative Part No	VPS45A	Alternative Part No	VPS45HY
Repair Kit	SEKMM.51	Repair Kit	EKMM.51 SEKMM.51	Repair Kit	EKMM.51.1 SEKMM.51.1	Repair Kit	EKMM.51.1 SEKMM.51.1

MULTI CIRCUIT PROTECTION VALVES - MAGNETI MARELLI

18.02.2004		18.02.2005		18.02.2003		18.02.2006	
							
Alternative Part No	VPS48A	Alternative Part No	VPS48H	Alternative Part No	VPS48HI	Alternative Part No	VPS48MIY
Repair Kit	EKMM.51.1 SEKMM.51.1	Repair Kit	EKMM.51.1 SEKMM.51.1	Repair Kit	EKMM.51.1 SEKMM.51.1	Repair Kit	EKMM.51.1 SEKMM.51.1
18.02.2007		18.02.2008					
							
Alternative Part No	VPS48NIY	Alternative Part No	VPS48AI K023346				
Repair Kit	EKMM.51.1 SEKMM.51.1	Repair Kit	EKMM.51.1 SEKMM.51.1				

MULTI CIRCUIT PROTECTION VALVES - WABCO

18.01.4958		18.01.6000		---		18.01.1000	
							
Alternative Part No	9325109582	Alternative Part No	9347010000	Alternative Part No	9347010410	Alternative Part No	9347020000
Repair Kit	EKWA.81 EKWA.80.2	Repair Kit	EKWA.51	Repair Kit	EKWA.51	Repair Kit	EKWA.51
18.01.1002		18.01.1005		18.01.1040		18.01.1041	
							
Alternative Part No	9347020020	Alternative Part No	9347020050	Alternative Part No	9347020400	Alternative Part No	9347020410
Repair Kit	EKWA.51	Repair Kit	EKWA.51	Repair Kit	EKWA.51	Repair Kit	EKWA.51

MULTI CIRCUIT PROTECTION VALVES (MCPV)

MULTI CIRCUIT PROTECTION VALVES - WABCO

18.01.1042		18.01.1045		18.01.1047		18.01.1082	
Alternative Part No	9347020420	Alternative Part No	9347020450	Alternative Part No	9347020470	Alternative Part No	9347020820
Repair Kit	EKWA.51	Repair Kit	EKWA.51	Repair Kit	EKWA.51	Repair Kit	EKWA.51.6
---		18.01.1100		18.01.1101		18.01.1110	
Alternative Part No	9347020830	Alternative Part No	9347021000	Alternative Part No	9347021010	Alternative Part No	9347021100
Repair Kit	EKWA.51	Repair Kit	EKWA.51.5	Repair Kit	EKWA.51.5	Repair Kit	EKWA.51.5
18.01.1122		18.01.1191		18.01.1192		18.01.1220	
Alternative Part No	9347021220	Alternative Part No	9347021910	Alternative Part No	9347021920	Alternative Part No	9347022200
Repair Kit	EKWA.51.5	Repair Kit	EKWA.51.4	Repair Kit	EKWA.51.5	Repair Kit	EKWA.51.5
18.01.1210		18.01.1221		18.01.1223		18.01.1240	
Alternative Part No	9347022100	Alternative Part No	9347022210	Alternative Part No	9347022230	Alternative Part No	9347022400
Repair Kit	EKWA.51.5	Repair Kit	EKWA.51.5	Repair Kit	EKWA.51.5	Repair Kit	EKWA.51
18.01.1250		18.01.1252		18.01.1260		18.01.1261	
Alternative Part No	9347022500	Alternative Part No	9347022520	Alternative Part No	9347022600	Alternative Part No	9347022610
Repair Kit	EKWA.51	Repair Kit	EKWA.51	Repair Kit	EKWA.51	Repair Kit	EKWA.51

MULTI CIRCUIT PROTECTION VALVES - WABCO

	
Alternative Part No	9347022700
Repair Kit	EKWA.51

	
Alternative Part No	9347022710
Repair Kit	EKWA.51

18.01.1300	
	
Alternative Part No	9347023000
Repair Kit	EKWA.51

18.01.1302	
	
Alternative Part No	9347023020
Repair Kit	EKWA.51

18.01.1320	
	
Alternative Part No	9347023200
Repair Kit	EKWA.51

18.01.1322	
	
Alternative Part No	9347023220
Repair Kit	EKWA.51

18.01.1323	
	
Alternative Part No	9347023230
Repair Kit	EKWA.51

18.01.1330	
	
Alternative Part No	9347023300
Repair Kit	EKWA.51

18.01.1340	
	
Alternative Part No	9347023400
Repair Kit	EKWA.51.5

18.01.1342	
	
Alternative Part No	9347023420
Repair Kit	EKWA.51.5

18.01.1380	
	
Alternative Part No	9347023800
Repair Kit	EKWA.51.6

18.01.1381	
	
Alternative Part No	9347023810
Repair Kit	EKWA.51.6

18.01.1387	
	
Alternative Part No	9347023870
Repair Kit	EKWA.51.6

18.01.1388	
	
Alternative Part No	9347023880
Repair Kit	EKWA.51

18.01.1391	
	
Alternative Part No	9347023910
Repair Kit	EKWA.51

18.01.2002	
	
Alternative Part No	9347050020
Repair Kit	EKWA.80

18.01.2003	
	
Alternative Part No	9347050030
Repair Kit	EKWA.80 EKWA.80.1A

18.01.2004	
	
Alternative Part No	9347050040
Repair Kit	EKWA.80

18.01.2005	
	
Alternative Part No	9347050050
Repair Kit	EKWA.80 EKWA.80.1

18.01.2006	
	
Alternative Part No	9347050060
Repair Kit	EKWA.80

MULTI CIRCUIT PROTECTION VALVES (MCPV)

MULTI CIRCUIT PROTECTION VALVES - WABCO

18.01.2008		18.01.3003		18.01.3004		18.01.3019	
Alternative Part No	9347050080	Alternative Part No	9347130030	Alternative Part No	9347130040	Alternative Part No	9347130190
Repair Kit	EKWA.80 EKWA.80.1A	Repair Kit	EKWA.51.7	Repair Kit	EKWA.51.7	Repair Kit	EKWA.51.7
18.01.3001		18.01.3003		18.01.3004		18.01.3006	
Alternative Part No	9347140010	Alternative Part No	9347140030	Alternative Part No	9347140040	Alternative Part No	9347140060
Repair Kit	EKWA.51.14	Repair Kit	EKWA.51.14	Repair Kit	EKWA.51.14	Repair Kit	EKWA.51.14
18.01.3010		18.01.3011		18.01.3012		18.01.3014	
Alternative Part No	9347140100	Alternative Part No	9347140110	Alternative Part No	9347140120	Alternative Part No	9347140140
Repair Kit	EKWA.51.14	Repair Kit	EKWA.51.14	Repair Kit	EKWA.51.14	Repair Kit	EKWA.51.14
18.01.3015		18.01.3016		18.01.3018		18.01.3019	
Alternative Part No	9347140150	Alternative Part No	9347140160	Alternative Part No	9347140180	Alternative Part No	9347140190
Repair Kit	EKWA.51.14	Repair Kit	EKWA.51.14	Repair Kit	EKWA.51.14	Repair Kit	EKWA.51.14
18.02.3211		18.01.3030		18.01.3037		18.01.3110	
Alternative Part No	9347140280	Alternative Part No	9347140300	Alternative Part No	9347140370	Alternative Part No	9347141100
Repair Kit	EKWA.51.14	Repair Kit	EKWA.51.14	Repair Kit	EKWA.51.14	Repair Kit	EKWA.51.14

MULTI CIRCUIT PROTECTION VALVES - WABCO

18.01.3119		18.01.3123		18.01.3125		18.01.3126	
							
Alternative Part No	9347141190	Alternative Part No	9347141230	Alternative Part No	9347141250	Alternative Part No	9347141260
Repair Kit	EKWA.51.14	Repair Kit	EKWA.51.14	Repair Kit	EKWA.51.14	Repair Kit	EKWA.51.14
18.02.3211		18.01.3732		18.01.3137		18.01.3145	
							
Alternative Part No	9347141280	Alternative Part No	9347141320	Alternative Part No	9347141370	Alternative Part No	9347141450
Repair Kit	EKWA.51.14	Repair Kit	EKWA.51.14	Repair Kit	EKWA.51.14	Repair Kit	EKWA.51.14
18.01.3150		18.01.3151		18.01.3152		18.01.3211	
							
Alternative Part No	9347141500	Alternative Part No	9347141510	Alternative Part No	9347141520	Alternative Part No	9347142110
Repair Kit	EKWA.51.14	Repair Kit	EKWA.51.14	Repair Kit	EKWA.51.14	Repair Kit	EKWA.51.14
18.01.3400		18.01.3401		18.01.3403		18.01.3730	
							
Alternative Part No	9347144000	Alternative Part No	9347144010	Alternative Part No	9347144030	Alternative Part No	9347147300
Repair Kit	EKWA.51.14	Repair Kit	EKWA.51.14	Repair Kit	EKWA.51.14	Repair Kit	EKWA.51.14
18.01.3732		18.01.3740		18.01.3320			
							
Alternative Part No	9347147320	Alternative Part No	9347147400	Alternative Part No	9347143200		
Repair Kit	EKWA.51.14	Repair Kit	EKWA.51.15	Repair Kit	EKWA.51.14		

MULTI CIRCUIT PROTECTION VALVES (MCPV)

EBS BOSCH KITS

EKBO.8.1



EBS HALDEX KITS

EKGH.51.3

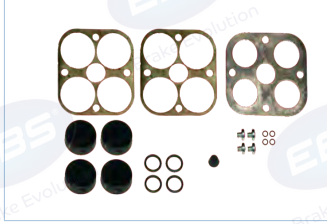

EBS MAGNETI MARELLI KITS

EKMM.51



EKMM.51.1

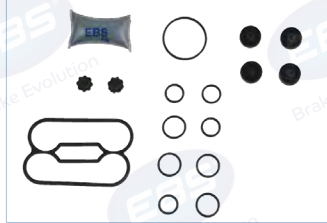

EBS KNORR BREMSE KITS

EKKB.3.3



EKKB.3.4



EKKB.3.6



EKKB.80



EKKB.80.1 (5V)



EKKB.80.1A (24V)



EKKB.81



EKKB.82



EKKB.83



EKKB.83.1



EBS WABCO KITS

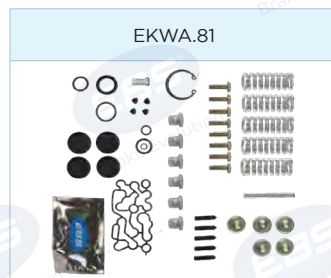
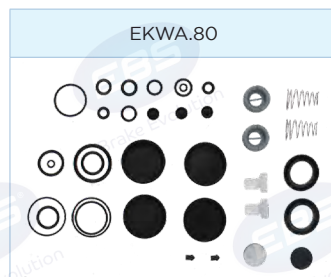

MULTI CIRCUIT PROTECTION VALVES (MCPV)

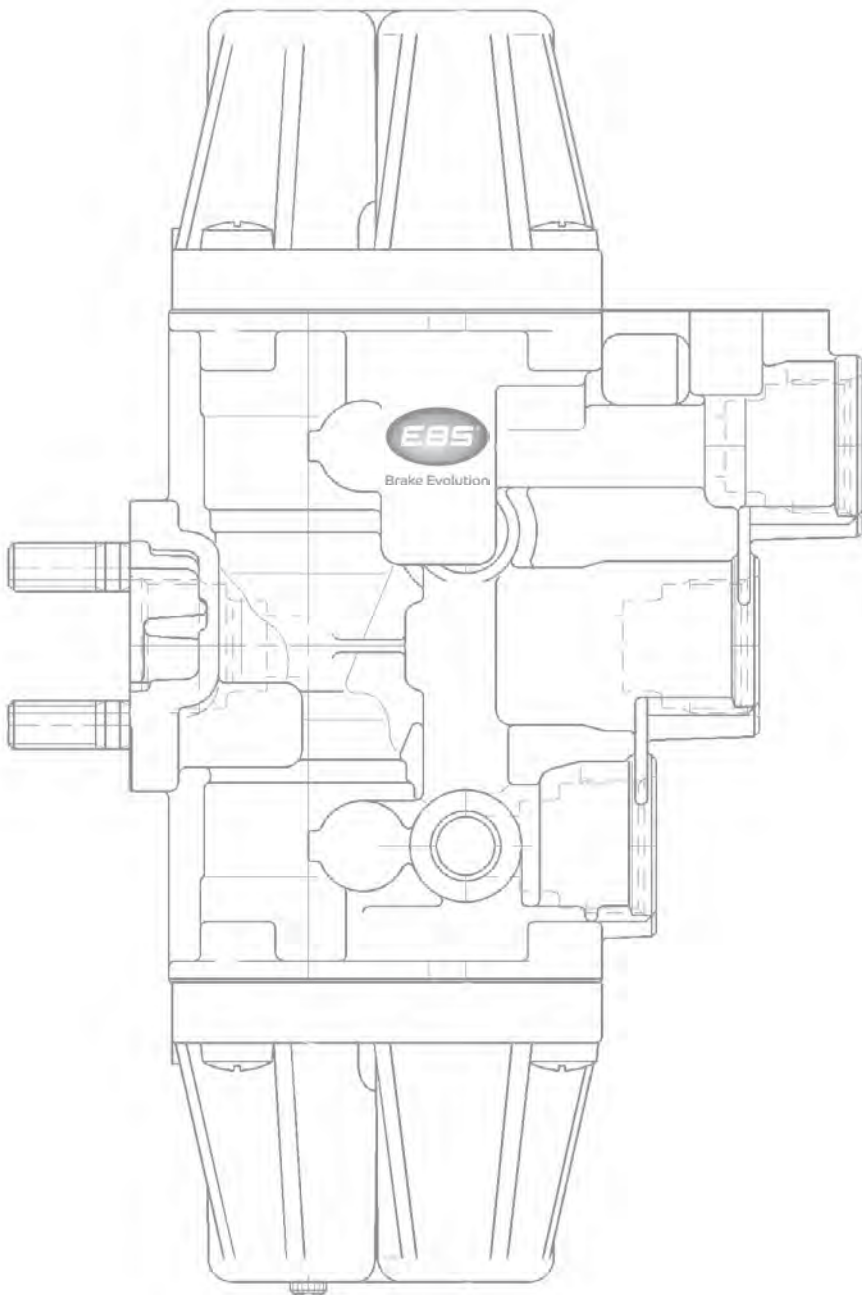

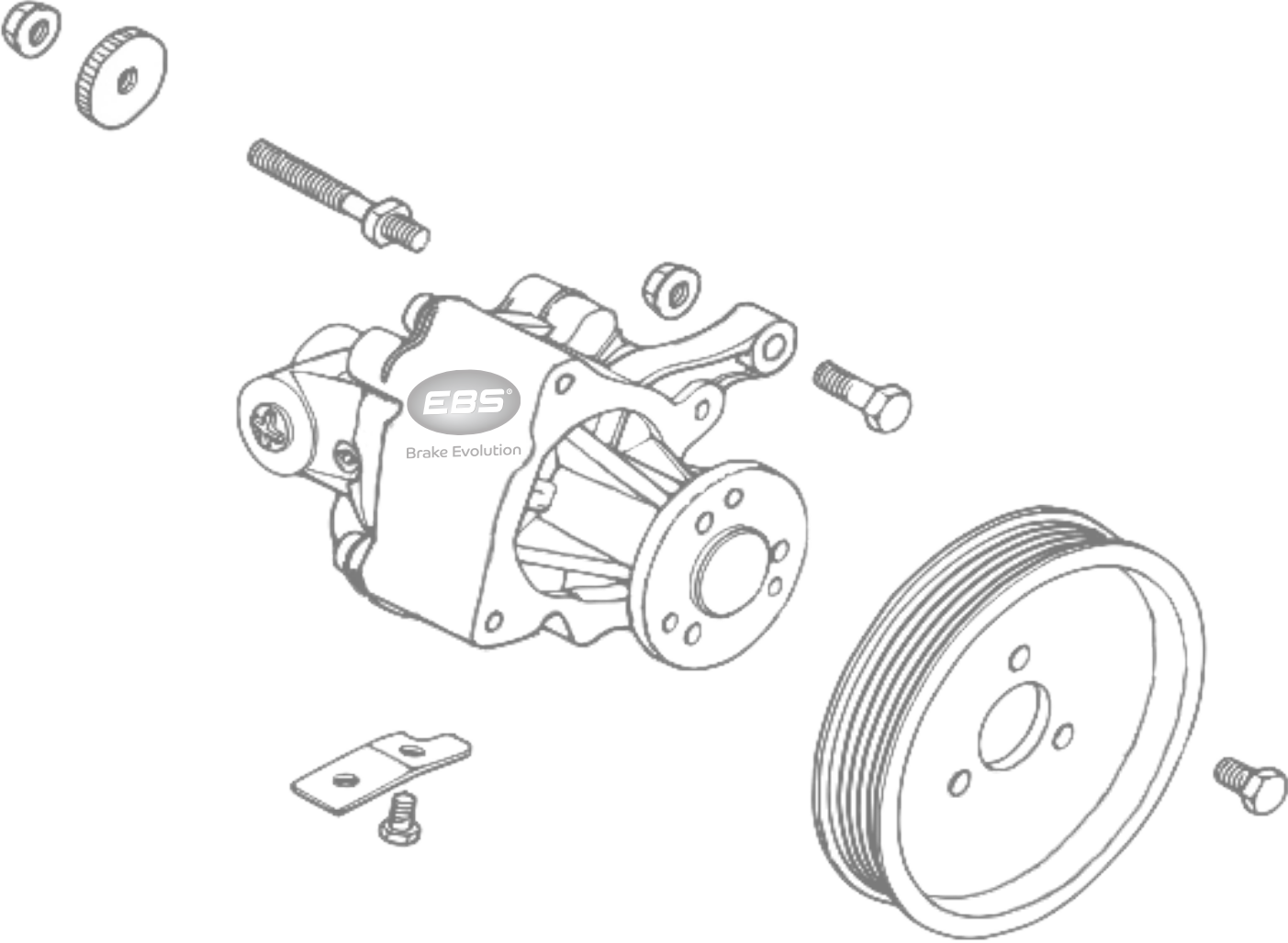

FUEL & POWER STEERING PUMPS

FUEL FILTER - MERCEDES

20.27.2000		
	Alternative Part No	A0000906050
	Pressure	---
	Rotation Direction	---
	Repair Kit	---

FUEL PUMPS - DAF

20.03.1001		
	Alternative Part No	1695495 1797650 8695671113
	Pressure	10 bar
	Rotation Direction	Anticlockwise
	Repair Kit	---

FUEL PUMPS - MACK

20.03.1003		
	Alternative Part No	0440020036 322GC45 322GC49A 332GC45
	Pressure	80 bar
	Rotation Direction	Anticlockwise
	Repair Kit	---

FUEL PUMPS - MERCEDES

20.01.1118		
	Alternative Part No	0014603080 0034601980 8695955147
	Pressure	200 bar
	Rotation Direction	Clockwise
	Repair Kit	---

20.27.1000		
	Alternative Part No	0040910501
	Pressure	10 bar
	Rotation Direction	Clockwise
	Repair Kit	---

FUEL PUMPS - SCANIA



20.03.1005		
	Alternative Part No	1518142
	Pressure	25 bar
	Rotation Direction	Anticlockwise
	Repair Kit	---

20.29.2000			
	Alternative Part No	1539298 1397682	1414025 1422449
	Pressure	6 Bar	
	Rotation Direction	Clockwise	
	Repair Kit	---	

FUEL FILTER - IVECO

20.25.2000		
	Alternative Part No	42545831
	16mm Ports	
	Repair Kit	---

FUEL PUMPS - VOLVO

20.01.1065		20.01.1066		---		20.30.2000/ SHORT ROD VERSION	
							
This is a combined Power Steering Pump & Fuel Pump							
Alternative Part No	20453450 20902690 7421017710 8694974519	Alternative Part No	20997341 8001860 85103778	Alternative Part No	7018955153 85103778	Alternative Part No	20440372 20441871 21539993 3092459 3165985 3964418 8148465 8148567
Pressure	---	Pressure	10 bar	Pressure	10 bar	Pressure	---
Rotation Direction	Anticlockwise	Rotation Direction	Anticlockwise	Rotation Direction	Anticlockwise	Rotation Direction	---
Repair Kit	---	Repair Kit	---	Repair Kit	---	Repair Kit	---
20.30.2001/ LONG ROD VERSION		20.30.2002					
							
Alternative Part No	20752310	Alternative Part No	21067551				
Pressure	---	Pressure	---				
Rotation Direction	---	Rotation Direction	---				
Repair Kit	---	Repair Kit	---				

POWER STEERING PUMPS - DAF

	20.01.1006	20.01.1007	20.01.1020	20.01.1028	20.01.1035	20.01.1044
						
Alternative Part No	0526663 1239411 1291227 1942001 2105576 542001410 8001449	542001710	7672955287	0647602 1955801 7673955217 8001455	624702 7674955207 8001468	7685955104 WAK7373Y39
Pressure	150 bar	---	150 bar	100 bar	---	150 bar
Rotation Direction	Anticlockwise	---	Anticlockwise	Anticlockwise	Anticlockwise	clockwise
Seals Kit	EKLU.2	EKLU.2	EKLU.2	---	---	---
Rotor Kit	---	---	---	---	---	---
Shaft & Bearing Kit	---	---	---	---	---	---
Plates Kit	---	---	---	---	---	---
Pressure Valve Kit	EKLU.21	EKLU.21	EKLU.21	---	---	---

FUEL & POWER STEERING PUMPS

POWER STEERING PUMPS - DAF

	20.01.1079	20.01.1130	20.01.1131	20.01.1132	20.01.1133	20.01.1134	20.01.1135
							
Alternative Part No	1375507 5420433H1 542043310 LH2110004	1375507	1450054	1401813 7684900111	1401926 7685900104	1687826 8695955139	1797644 7685955331
Pressure	---	---	---	200 bar	200 bar	180 bar	180 bar
Rotation Direction	Anticlockwise	Anticlockwise	Anticlockwise	Anticlockwise	Anticlockwise	Anticlockwise	Anticlockwise
Seals Kit	---	---	---	---	---	---	---
Rotor Kit	---	---	---	---	---	---	---
Shaft & Bearing Kit	---	---	---	---	---	---	---
Plates Kit	---	---	---	---	---	---	---
Pressure Valve Kit	---	---	---	---	---	---	---

POWER STEERING PUMPS - DEUTZ

EBS Part No	Alternative Part No	Pressure	Rotation Direction	Repair Kit				
				Seals Kit	Rotor Kit	Shaft & Bearing Kit	Plates Kit	Pressure Valve Kit
20.01.1111	01175656 5106153333	175 bar	Anticlockwise	---	---	---	---	---



POWER STEERING PUMPS - IVECO

	20.01.1032	20.01.1033	20.01.1036	20.01.1097	20.01.1098	20.01.1099	20.01.1100
							
Alternative Part No	42498432 42531697 7673955311	19632 42498433 4833411 7673955322 8001461	42498096 4708327 7674955232 8001469	4896314 7685900103 8001873	7673955702	7672955253	7674955306
Pressure	---	135 bar	135 bar	180 bar	100 bar	130 bar	---
Rotation Direction	Anticlockwise	Anticlockwise	Clockwise	Anticlockwise	Anticlockwise	Clockwise	Clockwise

	20.01.1101	20.01.1102	20.01.1126	20.01.1127	20.01.1128	20.01.1129	20.01.1141
							
Alternative Part No	7673955580	7673955572	7672955253	41211223 8695955116	41211093 7688955505	500327378 7683955126	4831152 7673955294
Pressure	130 bar	130 bar	130 bar	150 bar	165 bar	100 bar	180 bar
Rotation Direction	Clockwise	Clockwise	Clockwise	Anti-Clockwise	Anticlockwise	Anticlockwise	Anticlockwise

	20.01.10000	20.01.10001
		
Alternative Part No	504140125	504078368
Pressure	---	180 bar
Rotation Direction	Clockwise	Anti-Clockwise

FUEL & POWER STEERING PUMPS

POWER STEERING PUMPS - MAN







	20.01.1010	20.01.1011	20.01.1038	20.01.1043	20.01.1045	20.01.1054	20.01.1103
Alternative Part No	542002210 81471016136 81471016140 81471019082 81471019103	2107185 542002310 81471016122 81471016137 81471016162	2155201 7674955519 81471016031 81471016039 81471019189	542005910 7685955102 81471016181 8147106122	7685955152 81471016013 81471016031 81471016189 81471019189	7685955180 81471016162 81471016181 8147101916	542006710
Pressure	180 bar	150 bar	150 bar	150 bar	150 bar	150 bar	150 bar
Rotation Direction	Anticlockwise	Clockwise	Clockwise	Clockwise	Clockwise	Clockwise	Clockwise
Repair Kits	---	---	---	---	---	---	---

	20.01.1104	20.01.1105	20.01.1106	20.01.1120	20.01.1121	20.01.1122	20.01.1123
Alternative Part No	7685955184	7685955153	7674955245	7685955347 81471016219	7686955113	81471016186	7685955181 81471016136
Pressure	150 bar	150 bar	130 bar	180 bar	100 bar	165 bar	180 bar
Rotation Direction	Clockwise	Anticlockwise	Clockwise	Clockwise	Clockwise	Clockwise	Anticlockwise
Repair Kits	---	---	---	---	---	---	---

	20.01.1124	20.01.1141	20.01.1142	20.01.1159	20.01.1160
Alternative Part No	7685955154 542006710	542002210 7673955294 81471016082 81471016086 81471016090 81471016103 81471016116 81471016140	542043910 81471016186	7684955148	7687955123
Pressure	130 bar	180 bar	165 bar	000 bar	000 bar
Rotation Direction	Clockwise	Anticlockwise	Clockwise	Clockwise	Anticlockwise
Repair Kits	---	---	---	---	---

POWER STEERING PUMPS - MERCEDES

	20.01.1012	20.01.1014	20.01.1015	20.01.1021	20.01.1022	20.01.1034	20.01.1040
							
Alternative Part No	0004611480 0004666701 0014664301 0024665701 0986897 50420032H1 542003210 7673955116 7684955189	0014603080 0014605180 0024600880 0024603980 0034601980 542004710 8695955113 LH2112160	00146031800 0014605280 0034605180 542004810 8001902	0004602480 0004666701 5000504322 542003210 7673955116	004667101 1148301 7673955127	0014661301 1515101 7673955534	0004602680 0004606880 0014602880 542005010 7685955134
Pressure	100 bar	180 bar	180 bar	100 bar	100 bar	120 bar	120 bar
Rotation Direction	Clockwise	Clockwise	Clockwise	Clockwise	Clockwise	Anticlockwise	Clockwise
Seals Kit	---	---	---	EKZF.7	---	---	---
Rotor Kit	---	---	---	EKZF.9	---	---	---
Shaft & Bearing Kit	---	---	---	---	---	---	---
Plates Kit	---	---	---	---	---	---	---
Pressure Valve Kit	---	---	---	---	---	---	---

	20.01.1041	20.01.1052	20.01.1059	20.01.1060	20.01.1061	20.01.1071	20.01.1072
							
Alternative Part No	0004601480 0004606680 0004612480 0014606080 0024604080 0516280 1148201 542003210 7684955198	0014662701 001466280 7673955554	0014600580 001460058080 0014667601 7677955163 7677955201 8001511 955163	0014607080 0024606580 542005110	0024608880 0024608980 0034604980 542045310	0004601580 0014605980 0014664401 0024607580 542003110 7684955190	7684955921
Pressure	100 bar	100 bar	---	---	180 bar	83 bar	120 bar
Rotation Direction	Clockwise	Clockwise	Clockwise	Clockwise	Clockwise	Clockwise	Anticlockwise
Seals Kit	---	---	---	---	---	---	---
Rotor Kit	---	---	---	---	---	---	---
Shaft & Bearing Kit	---	---	---	---	---	---	---
Plates Kit	---	---	---	---	---	---	---
Pressure Valve Kit	---	---	---	---	---	---	---

FUEL & POWER STEERING PUMPS

POWER STEERING PUMPS - MERCEDES

	20.01.1073	20.01.1074	20.01.1075	20.01.1080	20.01.1082	20.01.1084	20.01.1085
Alternative Part No	3454660001 7673955908	0014662701 0014662801 0004667001 7673955125	7684955903	0014608580 0024605380 7685955149 7685955247	0014608480 7684955913	7684955911	7684955190
Pressure	130 bar	100 bar	100 bar	150 bar	---	80 bar	90 bar
Rotation Direction	Clockwise	Clockwise	Clockwise	Anticlockwise	Anticlockwise	Anticlockwise	Clockwise
Seals Kit	---	---	---	---	---	---	---
Rotor Kit	---	---	---	---	---	---	---
Shaft & Bearing Kit	---	---	---	---	---	---	---
Plates Kit	---	---	---	---	---	---	---
Pressure Valve Kit	---	---	---	---	---	---	---

	20.01.1086	20.01.1087	20.01.1088	20.01.1089	20.01.1090	20.01.1091	20.01.1092
Alternative Part No	3454660001 7673955908	542045310	7673955125	7673955125	7673955913	0014606880 001460688080 0014607280 0024604680 0004606180 5420050100	7684955903
Pressure	130 bar	180 bar	100 bar	100 bar	100 bar	155 bar	100 bar
Rotation Direction	Clockwise	Clockwise	Clockwise	Clockwise	Clockwise	Clockwise	Clockwise
Seals Kit	---	---	---	---	---	---	---
Rotor Kit	---	---	---	---	---	---	---
Shaft & Bearing Kit	---	---	---	---	---	---	---
Plates Kit	---	---	---	---	---	---	---
Pressure Valve Kit	---	---	---	---	---	---	---

POWER STEERING PUMPS - MERCEDES

	20.01.1093	20.01.1094	20.01.1095	20.01.1114	20.01.1116	20.01.1117	20.01.1118
							
Alternative Part No	542003810	7677955201	7677955163	7685955164	0024667501 0024667601 0034667201 7692900510	0024603180 0024605180 7685955251	0014603080 0034601980 8695955147
Pressure	80 bar	---	---	180 bar	---	165 bar	180 bar
Rotation Direction	Clockwise	Clockwise	Clockwise	Anticlockwise	Clockwise	Anticlockwise	Clockwise
Seals Kit	---	---	---	---	---	---	---
Rotor Kit	---	---	---	---	---	---	---
Shaft & Bearing Kit	---	---	---	---	---	---	---
Plates Kit	---	---	---	---	---	---	---
Pressure Valve Kit	---	---	---	---	---	---	---

	20.01.1119	20.01.1143	20.01.1144	20.01.1145	20.01.1146	20.01.1147	20.01.1148
							
Alternative Part No	0014603180 0034602280 8695955149	4574600280 7685955908	0034600380 542045410	0014664001 7673955545	0024601580 542009210	0014608080 542004910	0014604480 7684955139
Pressure	150 bar	---	180 bar	---	180 bar	---	---
Rotation Direction	Clockwise	Anticlockwise	Clockwise	Clockwise	Anticlockwise	Anticlockwise	Anticlockwise
Seals Kit	---	---	---	---	---	---	---
Rotor Kit	---	---	---	---	---	---	---
Shaft & Bearing Kit	---	---	---	---	---	---	---
Plates Kit	---	---	---	---	---	---	---
Pressure Valve Kit	---	---	---	---	---	---	---

FUEL & POWER STEERING PUMPS







POWER STEERING PUMPS - MERCEDES







	20.01.1149	20.01.1150	20.01.1151	20.01.1156	20.01.1161	20.01.1169
						
Alternative Part No	0024601380 7684955915	0024605580 7684955955	0034667201 7692900510	7685955249	8696955112	A9604600280
Pressure	---	130 bar	120 bar	150 bar	200 bar	Unlimited pressure
Rotation Direction	Anticlockwise	Anticlockwise	Clockwise	Anticlockwise	Clockwise	Anticlockwise
Seals Kit	---	---	---	---	---	---
Rotor Kit	---	---	---	---	---	---
Shaft & Bearing Kit	---	---	---	---	---	---
Plates Kit	---	---	---	---	---	---
Pressure Valve Kit	---	---	---	---	---	---

POWER STEERING PUMPS - RENAULT

	20.01.1062	20.01.1157	20.01.1158	20.01.1162	20.01.1166	20.01.1170
						
Alternative Part No	5001865396 5010600054	5001865386	542044310	5010600046	7421789078	7686.955.174
Pressure	225 bar	225 bar	000 bar	225 bar	165 bar	000 bar
Rotation Direction	Clockwise	Clockwise	Clockwise	Clockwise	Anticlockwise	Clockwise
Seals Kit	---	---	---	---	---	---
Rotor Kit	---	---	---	---	---	---
Shaft & Bearing Kit	---	---	---	---	---	---
Plates Kit	---	---	---	---	---	---
Pressure Valve Kit	---	---	---	---	---	---

POWER STEERING PUMPS - SCANIA

	20.01.1002	20.01.1003	20.01.1004	20.01.1005	20.01.1037	20.01.1039	20.01.1046
							
Alternative Part No	10571382 1308495 1457708 1571382 2105277 542000810 571382 571434	10571432 10571435 132422 1421273 1457709 1571432 1571435 542001010	10571297 10571437 1332653 1421628 1457711 1571297 1571437 542001210 571297	10571431 10571436 1333790 1422417 1439958 1457710 1571397 542001310 571436	0348792 0394443 10571370 1571370 7674955217 7674955284	10571028 10571364 1571364 255028 7677955106	10571394 112050 1123466 1305349 1571394 542000410
Pressure	---	---	---	---	130 bar	130 bar	---
Rotation Direction	Clockwise	Clockwise	Clockwise	Clockwise	Anticlockwise	Clockwise	Anticlockwise
Seals Kit	---	---	EKLU.2	EKLU.2	---	---	---
Rotor Kit	EKLU.3	EKLU.3	EKLU.3	EKLU.3	---	---	---
Shaft & Bearing Kit	EKLU.12	EKLU.12	EKLU.12	EKLU.12	---	---	---
Plates Kit	EKLU.17	EKLU.17	EKLU.17	EKLU.17	---	---	---
Pressure Valve Kit	EKLU.21	EKLU.21	EKLU.21	EKLU.21	---	---	---

	20.01.1058	20.01.1067	20.01.1068	20.01.1069	20.01.1070	20.01.1107	20.01.1108
							
Alternative Part No	571365 7677955108	571366 7677955107	7677955116	7677955110	0863297 10571393 1123465 1305348 1571393 50420003H1 542000310 571390 571393	7677955107	10571370 1571370 348792 394443 571369 571370 7674955217
Pressure	---	130 bar	130 bar	85 bar	130 bar	---	---
Rotation Direction	Clockwise	Anticlockwise	Clockwise	Clockwise	Anticlockwise	Clockwise	Anticlockwise
Seals Kit	---	---	---	---	---	---	---
Rotor Kit	---	---	---	---	---	---	---
Shaft & Bearing Kit	---	---	---	---	---	---	---
Plates Kit	---	---	---	---	---	---	---
Pressure Valve Kit	---	---	---	---	---	---	---

FUEL & POWER STEERING PUMPS

POWER STEERING PUMPS - SCANIA

	---	20.01.1110	20.01.1136	20.01.1137	20.01.1138
Alternative Part No	7673955110	1371404 1504006 7685955787	300130 7677955129	7685955956	1123465 542000310 571393
Pressure	---	---	130 bar	140 bar	130 bar
Rotation Direction	Clockwise	Clockwise	Anticlockwise	Clockwise	Anticlockwise
Seals Kit	---	---	---	---	---
Rotor Kit	---	---	---	---	---
Shaft & Bearing Kit	---	---	---	---	---
Plates Kit	---	---	---	---	---
Pressure Valve Kit	---	---	---	---	---

POWER STEERING PUMPS - VOLVO

	20.01.1000	20.01.1001	20.01.1008	20.01.1013	20.01.1016	20.01.1017	20.01.1019
Alternative Part No	1082959 2108165 3172199 542000110 8112286 8113432 8118286 8119432	542000710 50420007H1 2108142 3172499 6795109 8112342 8113461 8119461	3172197 542001810 8112963	1628208 2105480 3172193 542003710 8112593 8113268 8118593 8119268	3172490 542042510 8113282	2108156 2879901 3172488 542042610 85000047	20350652 3182312 50420434H1 542043410 8113586 8119586 LH2110006
Pressure	135 bar	---	---	---	---	---	---
Rotation Direction	Anticlockwise	Clockwise	Clockwise	Clockwise	Clockwise	Clockwise	Clockwise
Seals Kit	EKLU.2	---	---	---	---	EKLU.2	EKLU.2
Rotor Kit	---	---	EKLU.3	---	---	---	---
Shaft & Bearing Kit	---	---	EKLU.11	EKLU.11	EKLU.11	EKLU.11	---
Plates Kit	---	EKLU.17	EKLU.17	EKLU.17	EKLU.17	EKLU.17	EKLU.17
Pressure Valve Kit	---	EKLU.21	EKLU.21	EKLU.21	EKLU.21	EKLU.21	EKLU.21

POWER STEERING PUMPS - VOLVO

	20.01.1023	20.01.1024	20.01.1025	20.01.1026	20.01.1027	20.01.1029	20.01.1030
							
Alternative Part No	364642 5001454 7673955139	1195701 1589925 5001933 5007933 6879899 7673955202 8001453	1591014 5002281 7673955209	1585013 5001934 5007934 7673955211 8133047	1587787 1954301 5001938 5007938 7673955213	1195901 1587788 1591098 2225901 5007939 5008280 7673955219 8001456	1195601 1589231 1610367 5001935 5007935 7673955225 7673955963 8001457
Pressure	100 bar	135 bar	100 bar	135 bar	120 bar	120 bar	135 bar
Rotation Direction	Anticlockwise	Clockwise	Anticlockwise	Anticlockwise	Anticlockwise	Anticlockwise	Anticlockwise
Seals Kit	---	---	---	---	---	---	EKZF.1
Rotor Kit	---	---	---	---	---	---	EKZF.2
Shaft & Bearing Kit	---	---	---	---	---	---	---
Plates Kit	---	---	---	---	---	---	---
Pressure Valve Kit	---	---	---	---	---	---	---

	20.01.1031	20.01.1042	20.01.1057	20.01.1063	20.01.1064	20.01.1065	20.01.1081
							
Alternative Part No	1089887 7673955243 8001458 8113174 8119174	3986328 7684974704 8001514 85000031 85000180	1195801 1605904 5003175 5009175 7674955247 8001472	7684955763 8001872 85000094 85000972 85103704 85114316 85117316 8695671106	24424075 85000096 85000973 85006096 85103705 85114317 85999769 7685955791 8001883 8695671105	This is a combined Power Steering Pump & Fuel Pump	20902965 21188995 24424123 24424124 7686955729 85000256 85000770 85000974 85114318
Pressure	150 bar	---	---	---	---	---	200 bar
Rotation Direction	Anticlockwise	Clockwise	Anticlockwise	Anticlockwise	Anticlockwise	Anticlockwise	Anticlockwise
Seals Kit	---	---	---	---	---	---	---
Rotor Kit	---	---	---	---	---	---	---
Shaft & Bearing Kit	---	---	---	---	---	---	---
Plates Kit	---	---	---	---	---	---	---
Pressure Valve Kit	---	---	---	---	---	---	---

FUEL & POWER STEERING PUMPS

POWER STEERING PUMPS - VOLVO

	---	20.01.1113	20.01.1152	20.01.1153
				
Alternative Part No	7685955791 85103705 85114317	24424124 7686955729 85000770 85000974 85114318	7673955963	7673955395
Pressure	---	---	---	115 bar
Rotation Direction	Anticlockwise	Anticlockwise	Anticlockwise	Anticlockwise
Seals Kit	---	---	---	---
Rotor Kit	---	---	---	---
Shaft & Bearing Kit	---	---	---	---
Plates Kit	---	---	---	---
Pressure Valve Kit	---	---	---	---

	20.01.1154	20.01.1155	20.01.1167	20.01.1168
				
Alternative Part No	3986330 7685974704	4786919 7673955190	7685955628	7673955395
Pressure	---	120 bar	---	115 bar
Rotation Direction	Clockwise	Clockwise	Anticlockwise	Clockwise
Seals Kit	---	---	---	---
Rotor Kit	---	---	---	---
Shaft & Bearing Kit	---	---	---	---
Plates Kit	---	---	---	---
Pressure Valve Kit	---	---	---	---

POWER STEERING PUMPS - VW

20.01.1076		
	Alternative Part No	7673955816
	Pressure	---
	Rotation Direction	Anticlockwise
	Repair Kit	---

20.01.1077		
	Alternative Part No	7674975960
	Pressure	---
	Rotation Direction	Clockwise
	Repair Kit	---

EBS DAF REPAIR KITS



EBS MERCEDES REPAIR KITS

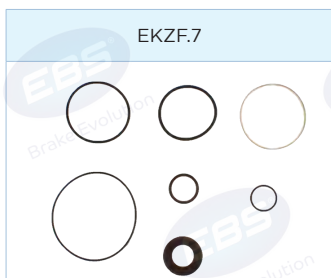

EBS SCANIA/VOLVO REPAIR KITS



FUEL & POWER STEERING PUMPS

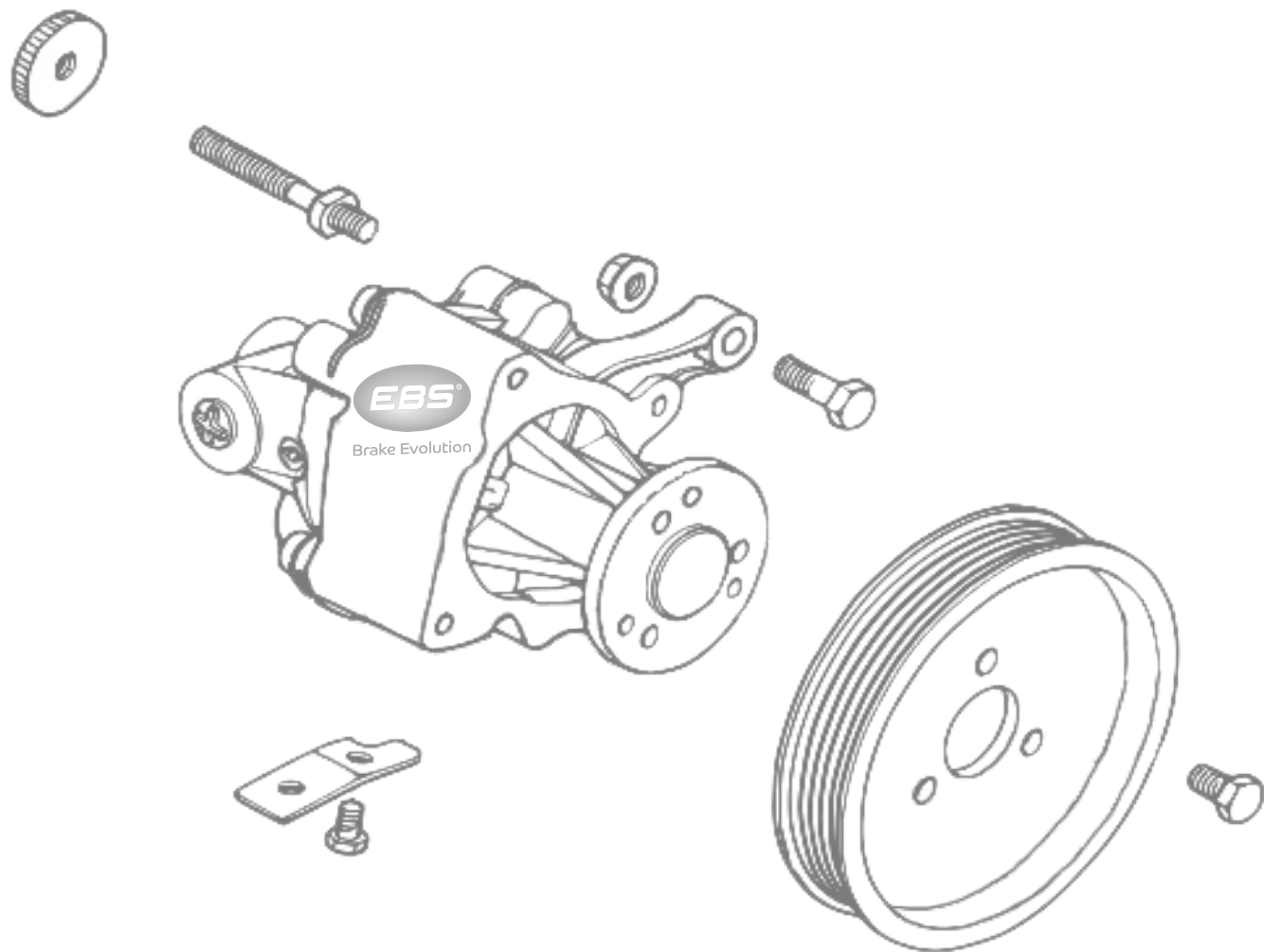

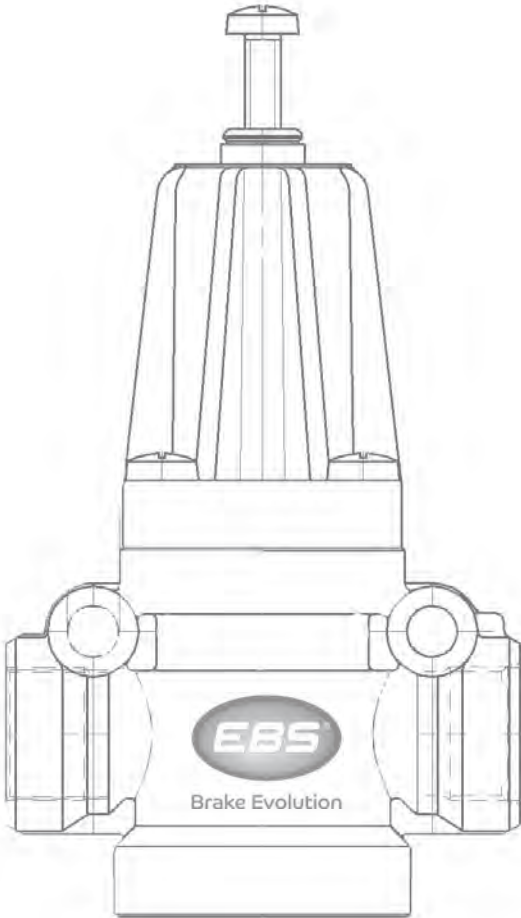
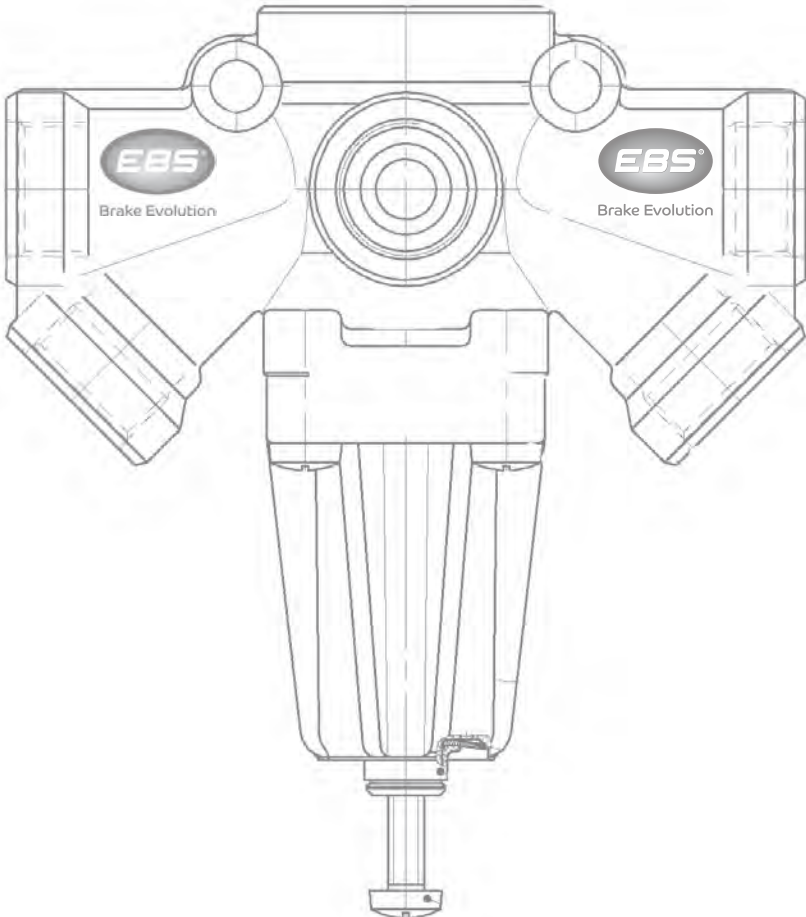



PRESSURE LIMITING VALVES - BENDIX

EBS Part No	Alternative Part No	Image	Info	Repair Kit
21.06.1011	217380	1	65 PSI	---
21.06.1012	220222	1	85 PSI	---
21.06.1013	228078	1	60 PSI	---
21.06.1014	271906	1	80 PSI	---
21.06.1015	274785	1	70 PSI	---
21.06.1007	277147	2	65 PSI	---
21.06.1009	277144	3	80 PSI	---
21.06.1008	277148	2	85 PSI	---
21.06.1010	277227	2	75 PSI	---
21.06.1023	277971	2	80 PSI	---
21.06.1024	281857	3	20 PSI	---
21.06.1025	278426	3	65 PSI	---
21.06.1026	1188664	3	42 PSI	---
21.06.1018	295035	3	60 PSI	---
21.06.1019	295393	3	30 PSI	---
21.06.1020	295452	3	100 PSI	---
21.06.1001	KX175/1	4(1/4 Nat)	155 PSI	---
21.06.1022	KX175/4	4 (1/4 Nat)	125 PSI	---

EBS Part No	Alternative Part No	Image	Info	Repair Kit
21.06.1002	KX1729/1	4(M16)	135 PSI	---
21.06.1003	KX1729/2	4 (M16)	150 PSI	---
21.06.1004	KX1729/3	4 (M16)	156 PSI	---
21.06.1005	KX175/5	4 (1/4 Nat)	135 PSI	---
21.06.1000	KX1729/4	4 (M16)	200 PSI	---
21.06.1006	KX1729/5	4 (M16)	180 PSI	---
21.06.1016	KX2045/16	5	110 PSI	---
21.06.1021	KX2045/17	5	40 PSI	---
21.06.1028	KX2073/10	4	180 PSI	---
21.06.1029	KX2073/13	4	200 PSI	---

LOW PRESSURE INDICATOR

EBS Part No	Alternative Part No	Image	Info	Repair Kit
21.06.1017	295472	6	55 PSI	---

PRESSURE LIMITING VALVES - BERTOCCO

EBS Part No	Alternative Part No	Image	Repair Kit
---	V2080165		---

PRESSURE LIMITING VALVES - BOSCH

EBS Part No	Alternative Part No	Image	Info	Repair Kit
21.04.9014	0481009014000	7	3.5 BAR	EKBO.5.8
21.04.9015	0481009015000	7	5.0 BAR	
21.04.9017	0481009017000	7	5.9 BAR	
21.04.9018	0481009018000	7	7.3 BAR	
21.04.9019	0481009019000	7	7.3 BAR	
21.04.9020	0481009020000	7	7.3 BAR	
21.04.9021	0481009021000	7	9.5 BAR	
21.04.9022	0481009022000	7	7.3 BAR	
21.04.9023	0481009023000	7	8.1 BAR	
21.04.9026	0481009026000	7	5.9 BAR	

7



8



9



10



11



PRESSURE LIMITING VALVES - BOSCH

EBS Part No	Alternative Part No	Image	Info	Repair Kit
21.04.9027	0481009027000	7	5.6 BAR	EKBO.5.8
21.04.9029	0481009029000	7	8.0 BAR	
21.04.9030	0481009030000	7	7.4 BAR	
21.04.9034	0481009034000	7	2.4 BAR	
21.04.9036	0481009036000	7	4.2 BAR	
21.04.9039	0481009039000	7	8.5 BAR	
21.04.9047	0481009047000	7	7.5 BAR	
21.04.9050	0481009050000	7	7.4 BAR	
21.04.9055	0481009055000	7	8.0 BAR	
21.04.9059	0481009059000	7	7.0 BAR	
21.04.9061	0481009061000	7	8.1 BAR	
21.04.9063	0481009063000	7	7.4 BAR	
21.04.9069	0481009069000	7	8.5 BAR	
21.04.9101	0481009101000	7	7.3 BAR	
21.04.9102	0481009102000	7	10.3 BAR	

ENGINE OVERFLOW VALVE - VOLVO

EBS Part No	Alternative	Image	Info
21.30.1000	21458307		---
21.30.1001	20941236		20 BAR

SAFETY VALVE- KNORR BREMSE

EBS Part No	Alternative Part No	Image
21.02.5118	184414 DR5118	12
21.02.5125	199812 DR5125	12

12



PRESSURE LIMITING VALVES - KNORR BREMSE

EBS Part No	Alternative	Image	Info	Repair Kit
21.01.4026	DB1102	8	5.7 BAR	---
21.01.4001	DB1103		5.3 BAR	---
21.07.2114	DB2114		2=1 RATIO	---
21.07.2115	186154 / DB2115	9	1.5=RATIO	---
21.07.2116	DB2116		1.15=1 RATIO	---
21.07.2118	186156 / DB2118		1.35=RATIO	---
21.07.2121	186157 / DB2121		1.8=RATIO	---
21.07.2122	186158 / DB2122		1.25=RATIO	---
21.07.2123	186159 / DB2123		2.7=RATIO	---
21.01.5004	DB1151	10	3.5 BAR	---
21.04.9030	DB1237 SEB01183		8.0 BAR	---
21.02.1240	DB1240 SEB01258	11	8.0 BAR	EKMM.36.40

SAFETY VALVE- WABCO

EBS Part No	Alternative Part No	Image
21.01.8226	4346082260	
21.01.8220	4346082200	
21.01.B004	4346120040	

PRESSURE LIMITING VALVES

13



14



15



16



17



PRESSURE LIMITING VALVES - MAGNETI MARELLI

EBS Part No	Alternative Part No	Image	Info	Repair Kit
21.07.152D	AC152DA	13	7.3 BAR	---
	AC152DX		7.3 BAR	
21.07.155F	AC155F	14	3.0 BAR	EKMM.36
	AC155FA		3.0 BAR	
21.07.156A	AC156A	14	7.5 BAR	
21.07.156B	AC156B	14	8.5 BAR	
21.07.156C	AC156C	14	9.5 BAR	
21.07.156D	AC156D	14	6.7 BAR	
21.07.156E	AC156E	14	11.0 BAR	
21.07.157C	AC157C	15	8.0 BAR	
21.07.157G	AC157G	15	4.2 BAR	
21.07.157L	AC157L	15	3.6 BAR	
21.07.157M	AC157M	15	7.0 BAR	
21.07.157P	AC157P	15	10.0 BAR	

PRESSURE LIMITING VALVES - WABCO

EBS Part No	Alternative Part No	Image	Repair Kit	EBS Part No	Alternative Part No	Image	Repair Kit						
21.01.5061	4213559312 4750150601	16	EKWA.36.1	21.01.3026	4750090260	21	EKWA.36.3						
---	4733000030	17	---	21.01.4000	4750100000		EKWA.36						
---	4733000130		---	21.01.4001	4750100010								
---	4733010000		---	21.01.4002	4750100020								
---	4733010010		---	21.01.4003	4750100030								
---	4733010030		---	21.01.4006	4750100060								
---	4733010130	18	EKWA.35.2	21.01.4008	4750100080								
---	4733020000			19	---			21.01.4009	4750100090				
---	4733020010							20	EKWA.36.3	21.01.4010	4750100100		
---	4733020020									21	EKWA.36.3	21.01.4011	4750100110
---	4750060100											21	EKWA.36.3
21.01.3000	4750090000	21	EKWA.36.3										
21.01.3004	4750090040			21	EKWA.36.3								
21.01.3005	4750090050							21	EKWA.36.3				
21.01.3008	4750090080									21	EKWA.36.3		
21.01.3022	4750090220					21						EKWA.36.3	21.01.4017

18



19



20



21



22



23



24



25



26



27



PRESSURE LIMITING VALVES - WABCO

EBS Part No	Alternative Part No	Image	Repair Kit
21.01.4021	4750100210	21	EKWA.36
21.01.4023	4750100230	21	EKWA.36
21.01.4024	4750100240	21	EKWA.36
21.01.4025	4750100250	21	EKWA.36
21.01.4026	4750100260	21	EKWA.36
21.01.4027	4750100270	21	EKWA.36
21.01.4032	4750100320	21	EKWA.36
21.01.4200	4750102000	22	EKWA.36.2
21.01.4201	4750102010	22	EKWA.36.2
21.01.4300	4750103000	22	EKWA.36.2
21.01.4305	4750103050	22	EKWA.36.2
21.01.4330	4750103300	22	EKWA.36.2
21.01.4301	4750103010	22	EKWA.36.2
21.01.4302	4750103020	22	EKWA.36.2
21.01.4304	4750103040	22	EKWA.36.2
21.01.4306	4750103060	22	EKWA.36.2
21.01.4307	4750103070	22	EKWA.36.2
21.01.4308	4750103080	22	EKWA.36.2
21.01.4309	4750103090	22	EKWA.36.2
21.01.4310	4750103100	22	EKWA.36.2
21.01.4311	4750103110	22	EKWA.36.2
21.01.4312	4750103120	22	EKWA.36.2
21.01.4313	4750103130	22	EKWA.36.2
21.01.4314	4750103140	22	EKWA.36.2
21.01.4315	4750103150	22	EKWA.36.2
21.01.4317	4750103170	22	EKWA.36.2
21.01.4318	4750103180	22	EKWA.36.2
21.01.4322	4750103220	22	EKWA.36.2
21.01.4324	4750103240	22	EKWA.36.2
21.01.4325	4750103250	22	EKWA.36.2
21.01.4328	4750103280	22	EKWA.36.2
21.01.4331	4750103310	22	EKWA.36.2
21.01.4332	4750103320	22	EKWA.36.2
21.01.4333	4750103330	22	EKWA.36.2
21.01.4335	4750103350	22	EKWA.36.2
21.01.4339	4750103390	22	EKWA.36.2
21.01.4400	4750104000	23	EKWA.36.2
21.01.5001	4750150010	24	EKWA.36.1
21.01.5004	4750150040	24	EKWA.36.1

EBS Part No	Alternative Part No	Image	Repair Kit
21.01.5005	4750150050	24	EKWA.36.1
21.01.5007	4750150070	24	EKWA.36.1
21.01.5008	4750150080	24	EKWA.36.1
21.01.5009	4750150090	24	EKWA.36.1
21.01.5010	4750150100	24	EKWA.36.1
21.01.5014	4750150140	24	EKWA.36.1
21.01.5015	4750150150	24	EKWA.36.1
21.01.5016	4750150160	24	EKWA.36.1
21.01.5018	4750150180	24	EKWA.36.1
21.01.5020	4750150200	24	EKWA.36.1
21.01.5026	4750150260	24	EKWA.36.1
21.01.5028	4750150280	24	EKWA.36.1
21.01.5029	4750150290	24	EKWA.36.1
21.01.5030	4750150300	24	EKWA.36.1
21.01.5031	4750150310	24	EKWA.36.1
21.01.5032	4750150320	24	EKWA.36.1
21.01.5033	4750150330	24	EKWA.36.1
21.01.5035	4750150350	24	EKWA.36.1
21.01.5036	4750150360	24	EKWA.36.1
21.01.5037	4750150370	24	EKWA.36.1
21.01.5039	4750150390	24	EKWA.36.1
21.01.5041	4750150410	24	EKWA.36.1
21.01.5045	4750150450	24	EKWA.36.1
21.01.5046	4750150460	24	EKWA.36.1
21.01.5048	4750150480	22	EKWA.36.1
21.01.5049	4750150490	24	EKWA.36.1
21.01.5060	4750150600	24	EKWA.36.1
21.01.5063	4750150630	24	EKWA.36.1
21.01.5065	4750150650	24	EKWA.36.1
21.01.5068	4750150680	24	EKWA.36.1
21.01.5072	4750150720	24	EKWA.36.1
21.01.5073	4750150730	24	EKWA.36.1
21.01.5300	4750153000	24	EKWA.36.1
21.01.5400	4750154000	24	EKWA.36.1
21.01.5501	4750155010	24	EKWA.36.1
21.01.5500	4750155000	24	EKWA.36.1
21.01.5503	4750155030	24	EKWA.36.1
21.01.5512	4750155120	24	EKWA.36.1
R21.01.A012	4750180120	25	EKWA.36.1

PRESSURE LIMITING VALVES

PRESSURE LIMITING VALVES - WABCO

EBS Part No	Alternative Part No	Image	Repair Kit
21.01.6000	9750010000	26	EKWA.59.1
21.01.6001	9750010010	26	EKWA.59.1
21.01.6002	9750010020	26	EKWA.59.1
21.01.7001	9750020010	27	EKWA.59
---	9750020020	27	EKWA.59
---	9750020050	27	EKWA.59
21.01.7017	9750020170	27	EKWA.59
21.01.7071	9750020170	27	EKWA.59
21.01.9001	9750090010	28	EKWA.59.4 EKWA.59.4.C

27



28



PRESSURE PROTECTION VALVES - HALDEX

21.03.3001

Alternative Part No
90554107

EBS BOSCH REPAIR KITS

EKBO.5.8

EKMM.36.40

EBS MAGNETI MARELLI REPAIR KITS

EKMM.36

EBS WABCO REPAIR KITS

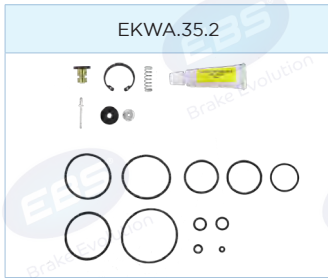

PRESSURE LIMITING VALVES

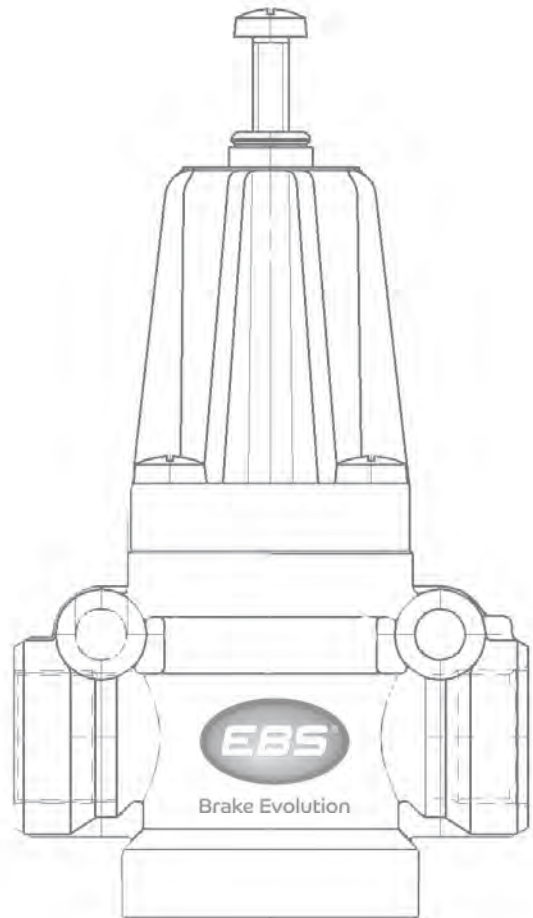
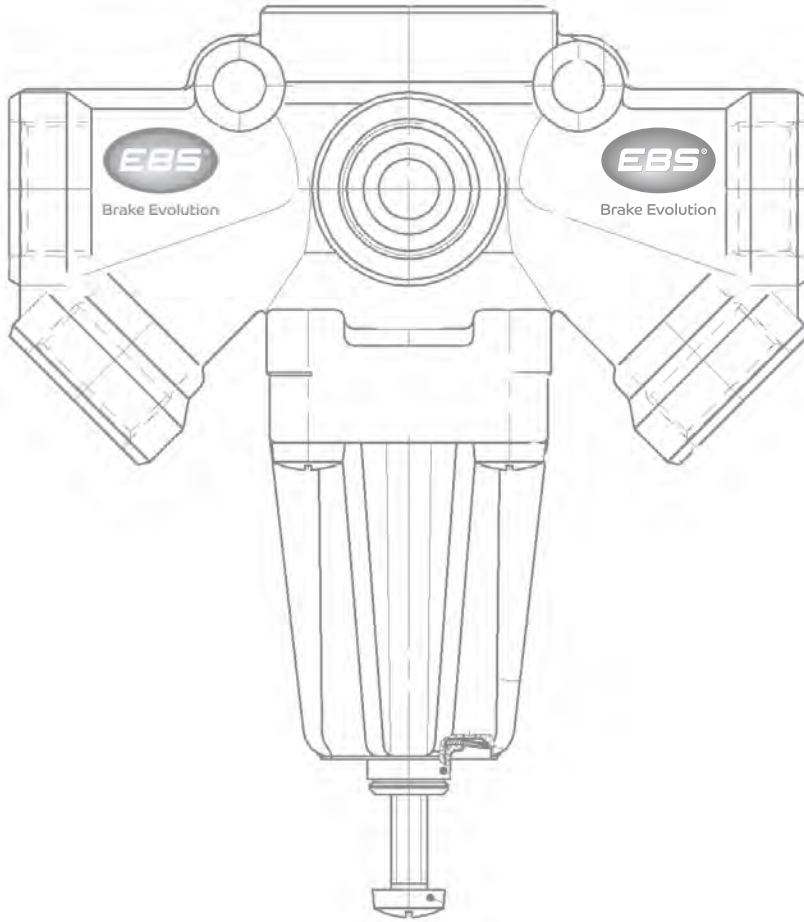

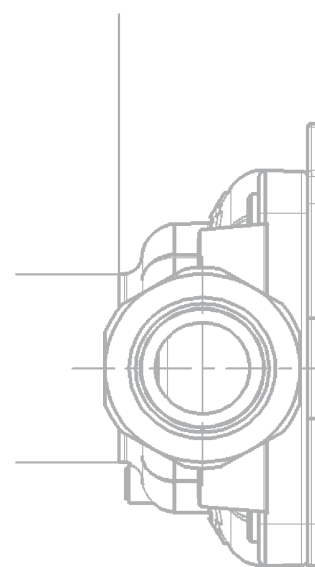
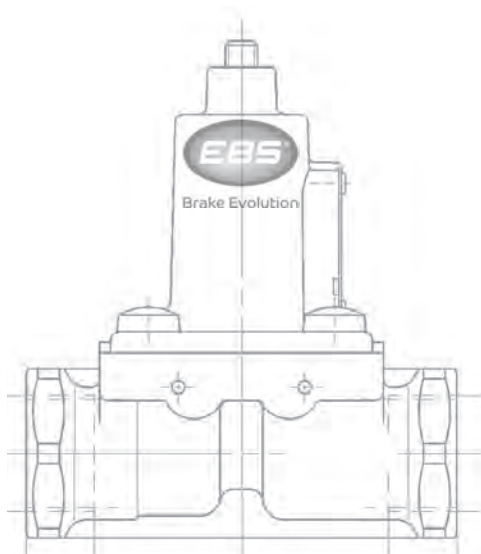
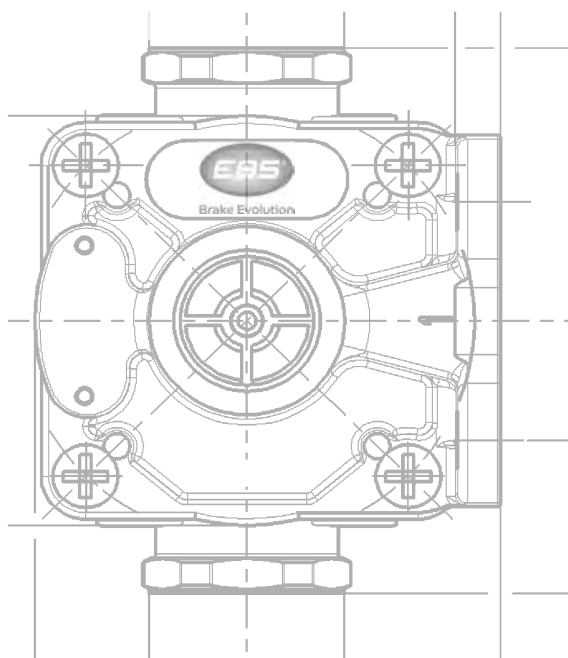
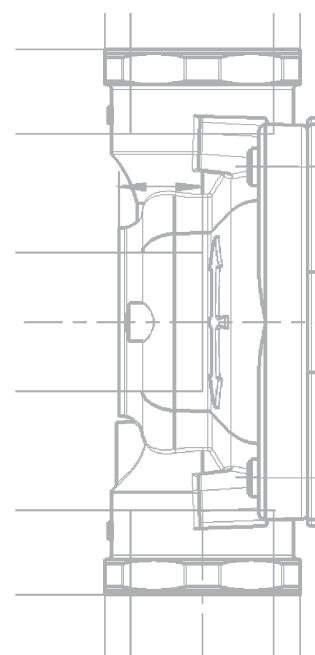
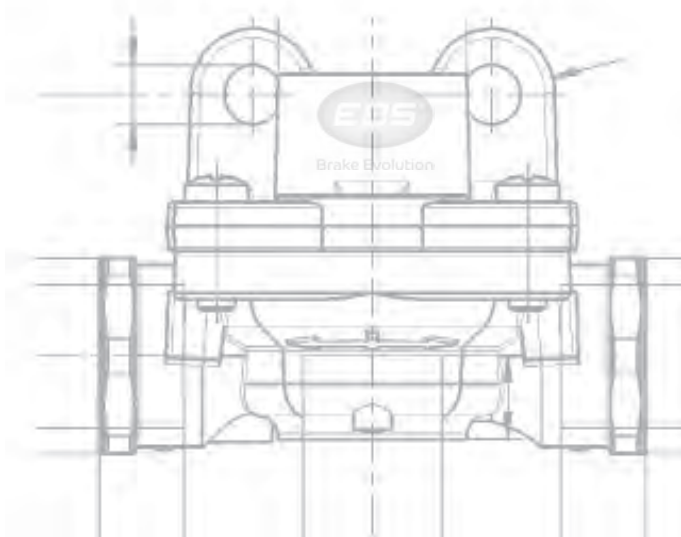

QUICK RELEASE & CHECK VALVES

EBS CHARGING VALVES - BOSCH

22.04.1001	
ALT. Part No.	0481063036000
Info	Without Backflow M22
Repair Kit	---

22.04.1000	
ALT. Part No.	0481063037000
Info	With Backflow M22
Repair Kit	---

22.04.1002	
ALT. Part No.	0481063041000
Info	Without Backflow M22
Repair Kit	---

EBS CHARGING VALVES HALDEX

22.03.1000	
ALT. Part No.	314014031
Info	Limited Backflow M22
Repair Kit	---

EBS CHARGING VALVES - KNORR BREMSE

22.02.1000	
ALT. Part No.	DR4132
Info	With Backflow M22 6.7 BAR
Repair Kit	---

22.02.1001	
ALT. Part No.	DR4156
Info	With Backflow M22 5.5 BAR
Repair Kit	---

EBS CHARGING VALVES - WABCO



EBS Part No	Alternative Part No	Information	Repair Kit
22.01.3020	4341000200	With Backflow M22 - 3.0 BAR	EKWA.13
22.01.3021	4341000210	With Backflow M22 - 3.5 BAR	EKWA.13
22.01.3022	4341000220	With Backflow M22 - 4.5 BAR	EKWA.13
22.01.3023	4341000230	With Backflow M22 - 5.5 BAR	EKWA.13
22.01.3024	4341000240	With Backflow M22 - 6.0 BAR	EKWA.13
22.01.3025	4341000250	With Backflow M22 - 6.5 BAR	EKWA.13

EBS Part No	Alternative Part No	Information	Repair Kit
22.01.3026	4341000260	With Backflow M22 - 1.0 BAR	EKWA.13
22.01.3027	4341000270	With Backflow M22 - 0.5 BAR	EKWA.13
22.01.3028	4341000280	With Backflow M22 -5.0 BAR	EKWA.13
22.01.3032	4341000320	With Backflow M22 - 10.5 BAR	EKWA.13
22.01.3033	4341000330	With Backflow M22 - 7.3 BAR	EKWA.13
22.01.3034	4341000340	With Backflow M22 - 6.8 BAR	EKWA.13
22.01.3035	4341000350	With Backflow M22 - 7.8 BAR	EKWA.13
22.01.3037	4341000370	With Backflow M22 - 1.6 BAR	EKWA.13
22.01.3039	4341000390	With Backflow M22 - 8.3 BAR	EKWA.13
22.01.3047	4341000470	With Backflow M22 - 10.3 BAR	EKWA.13
22.01.3048	4341000480	With Backflow M22 - 8.8 BAR	EKWA.13
22.01.3049	4341000490	With Backflow M22 - 9.2 BAR	EKWA.13
22.01.3051	4341000510	With Backflow M22 - 10.9 BAR	EKWA.13

EBS CHARGING VALVES - WABCO

EBS Part No	Alternative Part No	Information	Repair Kit	EBS Part No	Alternative Part No	Information	Repair Kit
22.01.3120	4341001200	Without Backflow M22 - 3.5 BAR	EKWA.13	22.01.3223	4341002230	Limited Backflow M22 - 4.0 BAR	EKWA.13
22.01.3122	4341001220	Without Backflow M22 - 4.5 BAR	EKWA.13	22.01.3224	4341002240	Limited Backflow M22 - 1.7 BAR	EKWA.13
22.01.3123	4341001230	Without Backflow M22 - 5.0 BAR	EKWA.13	22.01.3225	4341002250	Limited Backflow M22 - 6.8 BAR	EKWA.13
22.01.3124	4341001240	Without Backflow M22 - 5.5 BAR	EKWA.13	22.01.3227	4341002270	Limited Backflow M22 - 5.5 BAR	EKWA.13
22.01.3125	4341001250	Without Backflow M22 - 6.0 BAR	EKWA.13	22.01.3228	4341002280	Limited Backflow M22 - 6.4 BAR	EKWA.13
22.01.3126	4341001260	Without Backflow M22 - 6.5 BAR	EKWA.13	22.01.3230	4341002300	Limited Backflow M22 - 6.8 BAR	EKWA.13
22.01.3127	4341001270	Without Backflow M22 - 6.7 BAR	EKWA.13	22.01.3232	4341002320	Limited Backflow M22 - 8.5 BAR	EKWA.13
22.01.3128	4341001280	Without Backflow M22 - 5.3 BAR	EKWA.13	22.01.3234	4341002340	Limited Backflow M22 - 8.0 BAR	EKWA.13
22.01.3130	4341001300	Without Backflow M22 - 7.0 BAR	EKWA.13	22.01.3235	4341002350	Limited Backflow M22 - 4.2 BAR	EKWA.13
22.01.3131	4341001310	Without Backflow M22 - 7.3 BAR	EKWA.13	22.01.3236	4341002360	Limited Backflow M22 - 1.1 BAR	EKWA.13
22.01.3133	4341001330	Without Backflow M22 - 7.8 BAR	EKWA.13	22.01.3240	4341002400	Limited Backflow M22 - 5.5 BAR	EKWA.13
22.01.3134	4341001340	Without Backflow M22 - 8.3 BAR	EKWA.13	22.01.3244	4341002440	Limited Backflow M22 - 7.5 BAR	EKWA.13
22.01.3136	4341001360	Without Backflow M22 - 10.0 BAR	EKWA.13	22.01.3246	4341002460	Limited Backflow M22 - 7.3 BAR	EKWA.13
22.01.3139	4341001390	Without Backflow M22 - 8.5 BAR	EKWA.13	22.01.3249	4341002490	Limited Backflow M22 - 10.0 BAR	EKWA.13
22.01.3143	4341001430	Without Backflow M22 - 9.0 BAR	EKWA.13	22.01.3253	4341002530	Limited Backflow M22 - 6.1 BAR	EKWA.13
22.01.3144	4341001440	Without Backflow M22 - 10.8 BAR	EKWA.13	22.01.3257	4341002570	Limited Backflow M22 - 5.6 BAR	EKWA.13
22.01.3153	4341001530	Without Backflow M22 - 7.3 BAR	EKWA.13	22.01.3505	4341005050	Limited Backflow M22 - 6.7 BAR	EKWA.13
22.01.3220	4341002200	Limited Backflow M22 - 4.5 BAR	EKWA.13	22.01.3507	4341005070	Limited Backflow M22 - 5.5 BAR	EKWA.13
22.01.3221	4341002210	Limited Backflow M22 - 5.0 BAR	EKWA.13	22.01.3600	4341006000	Without Backflow M22 - 8.0 BAR	EKWA.13
22.01.3222	4341002220	Limited Backflow M22 - 6.2 BAR	EKWA.13				

EBS CHECK VALVES - SINGLE - BENDIX

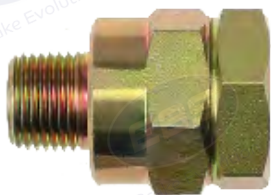
22.06.1000		22.06.1001		22.06.1002		22.06.1003		22.06.1004	
									
ALT. Part No.	295036	295358		ALT. Part No.	205001001 KW2966/1 KW3205/1	KW4455/1	KW4648/1		
Info	3/8" NPTF	M16		Info	1/2" - 14 NPTF	M22	M22		
Repair Kit	---	---		Repair Kit	EKBE.24				

QUICK RELEASE & CHECK VALVES

EBS CHECK VALVE - SINGLE - KNORR BREMSE

22.02.5131	
	
ALT. Part No.	K001349/ AE5131
Info	M22
Repair Kit	---

EBS CHECK VALVES - DOUBLE - KNORR BREMSE / P.D (DAHL)

22.02.4146	
	
ALT. Part No.	AE4146
Info	M16
Repair Kit	---

	
ALT. Part No.	AE4105/140405
Info	M16
Repair Kit	---

22.08.1000	
	
ALT. Part No.	1111419000/295358 333001201
Info	M16
Repair Kit	---

EBS CHECK VALVES - VOLVO

22.30.1000	
	
ALT. Part No.	85104850
Info	M16
Repair Kit	---

EBS CHECK VALVES - DOUBLE - WABCO

22.01.4000	22.01.4100	
		
ALT. Part No.	4342020000	4342021000
Info	M22 10 BAR	M22 10 BAR
Repair Kit	---	---

EBS CHECK VALVES - DOUBLE - WABCO

22.01.5000	22.01.5009	
		
ALT. Part No.	4342080000	4342080090
Info	M22 10 BAR	M16 10 BAR
Repair Kit	---	---

22.01.5021	22.01.5027	22.01.5029	
			
ALT. Part No.	4342080210	4342080270	4342080290
Info	M22 10 BAR	M22	M2210 BAR
Repair Kit	---	---	---

22.01.5050	
	
ALT. Part No.	4342080500
Info	M16 & M14 10 BAR
Repair Kit	---

22.01.5055	
	
ALT. Part No.	4342080550
Info	M16 10 BAR
Repair Kit	---

EBS CUT - OFF VALVE - DOUBLE - WABCO

22.01.9003	
	
ALT. Part No.	4345000030
Information	M22 10 BAR
Repair Kit	---

EBS DIFFERENTIAL PROTECTION VALVES - BENDIX

22.06.1058	
	
ALT.Part No.	KX1058/1
Information	3/8" NPTF
Repair Kit	---

EBS LINE FILTERS - WABCO

22.01.1020	
	
ALT.Part No.	4325000200
Information	M22 20 BAR
Repair Kit	---

EBS NON RETURN VALVES - WABCO

EBS Part No	Alternative Part No	Information	Image	Repair Kit
22.01.2000	4340140000	M22 18 BAR		---
22.01.2001	4340140010			---
22.01.7009	5340170090	14MM		N/A

QUICK RELEASE & CHECK VALVES

EBS PILOT VALVES - HALDEX

22.03.1003		22.03.1004	
			
ALT. Part No.	90554614	ALT. Part No.	90554615
Information	3 Way Port A = M12 Port B = M10 8.5 BAR	Information	3 Way Ports = 1/4" 8.5 BAR
Repair Kit	---	Repair Kit	---

EBS TWO CIRCUIT PROTECTION VALVE - WABCO

22.01.6003	
	
ALT. Part No.	4347000030
Information	M22 Ports Without Backflow 8 BAR
Repair Kit	EKWA.15

EBS QUICK RELEASE VALVE (WITH CHECK VALVE) - BENDIX

22.06.4000	
	
ALT. Part No.	289714N
Supp. (S)	1/4 NPT
Del. (D)	3/8 NPT
Exh. (E)	1/4 NPT
Repair Kit	---

EBS QUICK RELEASE VALVES - STD & PARALLEL 2 PORT & 4 PORT

EBS Part No	Alternative Part No	Image	Supp. (S)	Del. (D)	Exh. (E)	Repair Kit	
QRV1	274996	 <p>2 Port</p> <p>S</p> <p>D</p> <p>D</p> <p>E</p>	3/8	1/4	3/8		
	9735000110						
QRV2	274997		3/8	3/8	3/8		
	9735000030						
QRV3	274998		1/2	1/4	3/8		
QRV4	208002001		1/2	3/8	3/8		EKWA.59.2
	274999						
	9735000140						
QRV5	KX1294/1		M22	M16	M16		
QRV6	KX2000/1		 <p>4 Port</p> <p>S</p> <p>D</p> <p>D</p> <p>E</p>	M22	M22		M22
	9735000000						
QRV8	KX1294/2			M16	M16		M16
	9735000060 211171988						
QRV9	208003001	M16		M16	M16	---	
QRV10	208003031	M22		M22	M22	---	
QRV11	208003041	M22		M16	M22	---	
QRV12	208004021	1/2		1/4	3/8	---	

QUICK RELEASE & CHECK VALVES

EBS QUICK RELEASE VALVES - HALDEX

22.03.1001

ALT. Part No.	350036011
Supp. (s)	M16
Del. (D)	M16
Exh. (E)	M22
Repair Kit	---

ALT. Part No.	350036211
Supp. (s)	M22
Del. (D)	M16
Exh. (E)	M22
Repair Kit	---

ALT. Part No.	356001011
Supp. (s)	M22
Del. (D)	M22
Exh. (E)	M22
Repair Kit	---

QRV13

4 PORT PARALLEL

ALT. Part No.	356022001 356022011 1194339	356022031
Supp. (s)	M22	M22
Del. (D)	M16	M16
Exh. (E)	M22	M22
Repair Kit	---	---

QRV16

4 PORT PARALLEL

ALT. Part No.	356023001
Supp. (s)	M22
Del. (D)	M16
Exh. (E)	w/oThread
Repair Kit	---

QRV18

4 PORT PARALLEL

ALT. Part No.	356022031
Supp. (s)	M22
Del. (D)	M16
Exh. (E)	M22
Repair Kit	---

EBS QUICK RELEASE VALVES - KNORR BREMSE

QRV14

ALT. Part No.	1186892
Supp. (s)	M22
Del. (D)	M16
Exh. (E)	M22
Repair Kit	EKWA.59.2

QRV17

ALT. Part No.	KX2552/3
Supp. (s)	M22
Del. (D)	M16 (x2)
Exh. (E)	M22
Repair Kit	EKWA.59.2

EBS QUICK RELEASE VALVES - WABCO

ALT. Part No.	4735012010
Supp. (s)	M22
Del. (D)	M22
Exh. (E)	M22
Repair Kit	EKWA.59.2

ALT. Part No.	4735012030
Supp. (s)	M22
Del. (D)	M22
Exh. (E)	M22
Repair Kit	EKWA.59.2

QRV14	
ALT. Part No.	9735000180
Supp. (s)	M22
Del. (D)	M16
Exh. (E)	M22
Repair Kit	EKWA.59.2

22.01.8028	
ALT. Part No.	9735000280
Supp. (s)	M22
Del. (D)	M22(x3)
Exh. (E)	SnapOn
Repair Kit	EKWA.59.2

22.01.8031	
ALT. Part No.	9735000310
Supp. (s)	M22
Del. (D)	M22 (x2) M16 (x1)
Exh. (E)	Snap On
Repair Kit	EKWA.59.2

22.01.8034	
ALT. Part No.	9735000340
Supp. (s)	M22
Del. (D)	M22
Exh. (E)	Snap On
Repair Kit	EKWA.59.2

22.01.8038	
ALT. Part No.	9735000380/ 119439/ QRV7
Supp. (s)	M22
Del. (D)	M16
Exh. (E)	M22
Repair Kit	EKWA.59.2

22.01.8039	
ALT. Part No.	9735000390
Supp. (s)	M22
Del. (D)	M22
Exh. (E)	M22
Repair Kit	EKWA.59.2

22.01.8042	
ALT. Part No.	9735000420
Supp. (s)	M22
Del. (D)	M22
Exh. (E)	M22
Repair Kit	EKWA.59.2

QUICK RELEASE & CHECK VALVES

EBS QUICK RELEASE VALVES - WABCO

QRV15

Coated in Protection Paint

ALT. Part No.	9735000440
Supp. (s)	M22
Del. (D)	M22
Exh. (E)	M22
Repair Kit	EKWA.59.2

22.01.8045

ALT. Part No.	9735000450
Supp. (s)	M22
Del. (D)	M22
Exh. (E)	c/w Silencer
Repair Kit	EKWA.59.2

22.01.8051

ALT. Part No.	9735000510
Supp. (s)	M22
Del. (D)	M16
Exh. (E)	M22
Repair Kit	----

22.01.8053

ALT. Part No.	9735000530
Supp. (s)	M16
Del. (D)	M16
Exh. (E)	c/w Silencer
Repair Kit	----

22.01.8057

ALT. Part No.	9735000570
Supp. (s)	M16
Del. (D)	M16
Exh. (E)	M16
Repair Kit	----

22.01.8059

ALT. Part No.	9735000590
Supp. (s)	M22
Del. (D)	M22 (x2)
Exh. (E)	c/w Silencer
Repair Kit	EKWA.59.2

For Silencers please see page 90.8, 90.9

EBS BENDIX REPAIR KITS

EKBE.24

EBS WABCO REPAIR KITS

EKWA.13

EKWA.15

EKWA.59.2

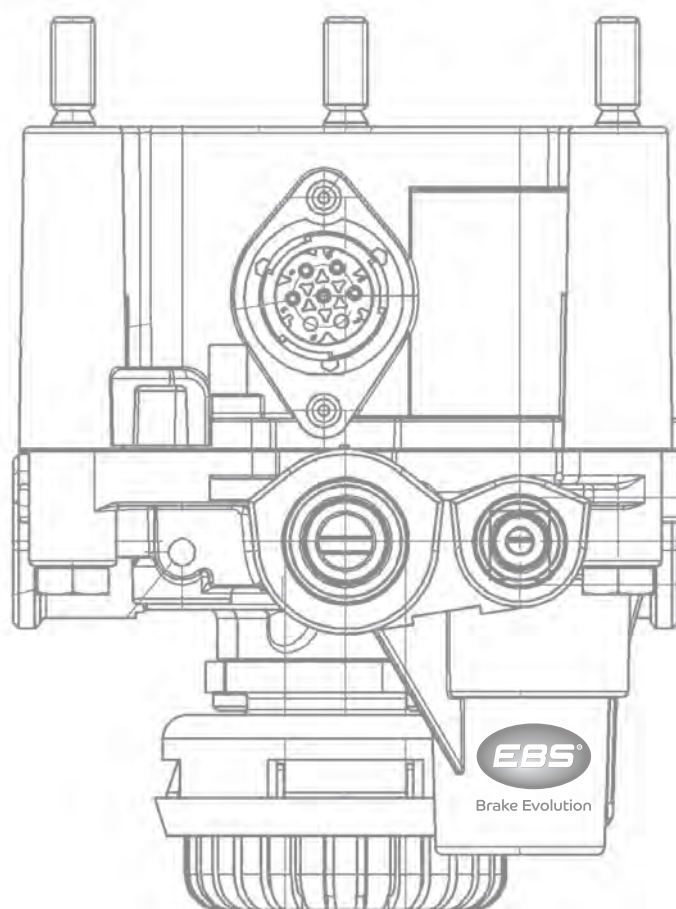
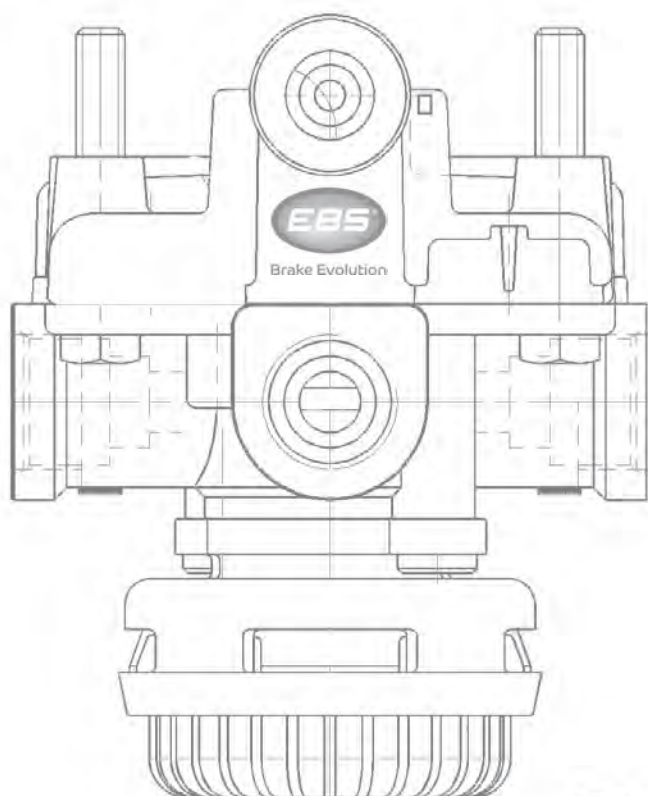

RELAY VALVES - AMERICAN BENDIX

---		---		---		---	
Alternative Part No	102166	Alternative Part No	102998	Alternative Part No	103833	Alternative Part No	109264
Port 1 & 2: 1/2" NPTF Port 4: 1/4" NPTF		Port 1 & 2: 1/2" NPTF Port 4: 1/4" NPTF		Port 1 & 2: 1/2" NPTF Port 4: 1/4" NPTF		Port 1 & 2: 1/2" NPTF Port 4: 1/4" NPTF	
Repair Kit	EKBE.71	Repair Kit	EKBE.71	Repair Kit	EKBE.71	Repair Kit	EKBE.71

SUPPLY DUMP VALVE - BENDIX

R6 RELAY VALVES - BENDIX

R23.06.2001		R23.06.2002		23.06.1005		23.06.1000	
Alternative Part No	KY1482/1	Alternative Part No	KY1482/8	Alternative Part No	280375DK	Alternative Part No	295071
(IMPERIAL)		(METRIC)		Port 1: 1/2" NPTF Port 2: 3/8" NPTF Port 4: 1/4" NPTF		Port 1: 1/2" NPTF Port 2: 3/8" NPTF Port 4: 1/4" NPTF	
Repair Kit	SK2788/1	Repair Kit	SK2788/1	Repair Kit	EKBE.45 or EKBE.45.C	Repair Kit	EKBE.45 or EKBE.45.C

R6 RELAY VALVES - BENDIX

23.06.1011		23.06.1002		23.06.1008		23.06.1009	
Alternative Part No	295198	Alternative Part No	295199	Alternative Part No	295249	Alternative Part No	295295
Port 1: Plugged Port 2: 3/8" NPTF Port 4: 1/4" NPTF Reservoir Mount: 3/4" NPTF		Port 1: M22 Port 2: M16 Port 4: M12		Port 1: 1/2" NPTF Port 2: 3/8" NPTF Port 4: 1/4" NPTF		Port 1: 1/2" NPTF Port 2: 3/8" NPTF Port 4: 1/4" NPTF	
Repair Kit	EKBE.45 or EKBE.45.C	Repair Kit	EKBE.45 or EKBE.45.C	Repair Kit	EKBE.45 or EKBE.45.C	Repair Kit	EKBE.45 or EKBE.45.C

R6 & RE6 RELAY VALVES BENDIX

23.06.1001		---		23.06.1006	
					
Alternative Part No	295528	Alternative Part No	KY992/1	Alternative Part No	281672 281865N
Port 1: M22 Port 2: M16 Port 4: M12		Port 1: 1/2" NPTF Port 2 & 4: 3/8" NPTF		Port 1: 1/2" NPTF Port 2: 3/8" NPTF Port 4: 1/4" NPTF	
Repair Kit	EKBE.45 or EKBE.45.C	Repair Kit	EKBE.45 or EKBE.45.C	Repair Kit	EKBE.46 or EKBE.46.1

R8 RELAY VALVES - BENDIX

23.06.1003		23.06.1004	
			
Alternative Part No	101930N	Alternative Part No	KY1810/1
R8 Port 1 & 2: M22 Port 4: M12		R8A Port 1 & 2: 3/8" NPTF Port 4: 1/4" NPTF	
Repair Kit	EKBE.65.1 or EKBE.65.2	Repair Kit	EKBE.65.1 or EKBE.65.2

R9A RELAY VALVES BENDIX

R23.06.1007	
	
Alternative Part No	267114
R9A Port 1 & 2: 3/8" NPTF Port 4: 1/4" NPTF	
Repair Kit	---

RELAY VALVES - BENDIX

---		---	
			
Alternative Part No	271483	279919	
Port 1 & 4: 1/4" NPTF Port 2: 3/4" NPTF & 1/4" NPTF			
Repair Kit	EKBE.43		

23.07.1000	
	
Alternative Part No	KY2308/1
All Ports: M22	
Repair Kit	---

23.06.2071	
	
Alternative Part No	272071
All Ports: M22	
Repair Kit	---

	
Alternative Part No	M2310000
All Ports: M22	
Repair Kit	---

RELAY VALVES

RELAY VALVES - BOSCH

23.01.3020		23.04.1001		23.04.1002		23.04.1003	
Alternative Part No	0481026005000	Alternative Part No	0481026019000 0481026021000	Alternative Part No	0481026022000 0481026032000	Alternative Part No	0481026023000
Port 1: M22 Port 2 & 4: M16		Port 1 & 2: M22 Port 4: M16		Port 1 & 2: M22 Port 4: M16		Port 1 & 2: M22 Voss Port 4: M16 Voss	
Repair Kit	EKBO.10.1	Repair Kit	EKBO.10.4	Repair Kit	EKBO.10.4	Repair Kit	EKBO.10.11
23.04.1004		23.04.1005		23.04.1000		23.04.1008	
Alternative Part No	0481026026000	Alternative Part No	0481026027000	Alternative Part No	0481026302000	Alternative Part No	0481026303000
Port 1 & 2: M22 Port 4: M16		Port 1: M22 Port 2: 3xM16 1xM22 Port M16		Port 1: M22 Port 2 & 4: M16		Port 1 & 2: M22 Voss Port 4: M16 Voss	
Repair Kit	EKBO.10.11	Repair Kit	EKBO.10.5	Repair Kit	EKBO.57.3	Repair Kit	EKBO.57.3 or EKBO.10.10
23.04.1007		23.04.1008					
Alternative Part No	0481026306000	Alternative Part No	0481026307000				
Port 1 & 2: M22 Voss Port 4: M16 Voss		Port 1 & 2: M22 Voss Port 4: M16 Voss					
Repair Kit	EKBO.57.3	Repair Kit	EKBO.57.3 or EKBO.10.10				

RELAY VALVES - CLAYTON DEWANDRE

EBS Part No	Alternative Part No	Information	Repair Kit	Image
23.09.1000	APSA10473/1	Mini Relay	EKCD.104.73	

RELAY VALVES - HALDEX

23.03.1000		23.03.1001		23.03.1003		---	
							
Alternative Part No	201002001	Alternative Part No	201020020	Alternative Part No	KN30400	Alternative Part No	350026002
Ports: Imperial		Port 1 & 2:M22 Port 4:M16		Service ¼ NPT Emer ¼ NPT Del ⅜ NPT Supply ¼ NPT		All Ports: M22	
Repair Kit	EKGH.46	Repair Kit	---	Repair Kit	---	Repair Kit	---

23.01.2150		---		23.01.2150		---	
							
Alternative Part No	351008022	Alternative Part No	351008023	Alternative Part No	351008122	Alternative Part No	351008123
Universal Version All Ports: M22		UniversalVersion All Ports:M22		Universal Version All Ports: M22		Universal Version Ports: 1 x M16 4 x M22	
Repair Kit	EKGH.2	Repair Kit	EKGH.2	Repair Kit	EKGH.2	Repair Kit	EKGH.2

---		---		23.01.2152		---	
							
Alternative Part No	351009021	Alternative Part No	351009121	Alternative Part No	351022001	Alternative Part No	351033001
Universal Version All Ports:M22		Universal Version Ports: 1 x M16 4 x M22		Ports: 5 x M16 4 x M22		Relay Emergency For EB+	
Repair Kit	EKGH.2	Repair Kit	EKGH.2	Repair Kit	EKGH.2	Repair Kit	---

23.03.1002		23.01.3010		23.01.3010	
					
Alternative Part No	355018001	Alternative Part No	355018011	Alternative Part No	355023061
Port 1 & 2: M22 Port 4: M16		All Ports: M22		All Ports: M22	
Repair Kit	EKGH.34	Repair Kit	---	Repair Kit	---

RELAY VALVES

RELAY VALVES - HINO

EBS Part No	Alternative Part No	Information	Image
23.37.1000	44540-1290	Port 1 & 2: M24 Port 4: 1/4" NPTF	

RELAY VALVES - KNORR BREMSE (APU)

23.02.10001	
Alternative Part No	K035696K50

RELAY VALVES - KNORR BREMSE (APU)

23.02.1001	---	23.02.1000	---
Alternative Part No AC579BK/ K008433	Alternative Part No AS3000A-B	Alternative Part No AS3012	Alternative Part No AS3018
All Ports: M22	All Ports: M22	Port 1: M22 Port 2: M22 & M16 Port 4: M22	Port 1: M16 & M22 Port 2: M16 & M22 Port 4: M22
Repair Kit ---	Repair Kit EKPD.2	Repair Kit EKPD.2	Repair Kit EKPD.2

---	23.01.2152	---	---
Alternative Part No AS3050A	Alternative Part No AS3054	Alternative Part No AS3100A	Alternative Part No AS3250 K109377N00
All Ports: M22	Port 1: M16 & M22 Port 2: M16 & M22 Port 4: M16	All Ports: M22	Ports 1: M16 & M22 Ports 2: M16 & M22 Port 4: M16
Repair Kit EKPD.2	Repair Kit EKPD.2	Repair Kit EKPD.2	Repair Kit EKPD.2

---	---	---	---
Alternative Part No RE1100	Alternative Part No RE1102	Alternative Part No RE1104	Alternative Part No RE1105
All Ports: M22	All Ports: M22	All Ports: M22	All Ports: M22
Repair Kit EKKB.4	Repair Kit EKKB.4	Repair Kit EKKB.4	Repair Kit EKKB.4

RELAY VALVES - KNORR BREMSE

---		23.01.3020		---		23.01.3020	
							
Alternative Part No	RE1108	Alternative Part No	RE1115	Alternative Part No	RE1119	Alternative Part No	RE1121
All Ports: M22		Port 1: M22 Other Ports: M16		Ports 1 & 2: M22 Other Ports: M16		Ports 1 & 3: M22 Other Ports: M16	
Repair Kit	EKKB.4	Repair Kit	EKKB.4	Repair Kit	EKKB.4	Repair Kit	EKKB.4
---		---		---		---	
							
Alternative Part No	RE1126	Alternative Part No	RE1132	Alternative Part No	RE1137	Alternative Part No	RE1138
Port 1: M22 Other Ports: M16		Ports 1 & 2: M22 Other Ports: M16		Port 1: M22 Other Ports: M16		Ports 1 & 2: M22 Other Ports: M16	
Repair Kit	EKKB.4	Repair Kit	EKKB.4	Repair Kit	EKKB.4	Repair Kit	EKKB.4
---		---		---		---	
							
Alternative Part No	RE1141	Alternative Part No	RE1201	Alternative Part No	RE2221	Alternative Part No	RE2224
Port 1: M22 Other Ports: M16		Port 1: M22 Other Ports: M16		All Ports: M22		All Ports: M22	
Repair Kit	EKKB.4	Repair Kit	EKKB.4	Repair Kit	EKKB.4	Repair Kit	EKKB.4
---		---		---		---	
							
Alternative Part No	RE2225	Alternative Part No	RE2228	Alternative Part No	RE3312	Alternative Part No	K016654 RP2B
Ports 1 & 2: M22 Port 4: M14		All Ports: M22		All Ports: M22		All Ports: M22	
Repair Kit	EKKB.4.6	Repair Kit	EKKB.4	Repair Kit	EKKB.4	Repair Kit	---

RELAY VALVES

RELAY VALVES - MAGNETI MARELLI

---		---		23.07.1000	
Alternative Part No	AC571AX	Alternative Part No	AC574AA	Alternative Part No	AC574AXY
					W/O Stud Nuts
				Alternative Part No	AC574CXY
					C/W Stud Nuts
Port 1 & 2:M22		Port 1 & 2: M22		Port1& 2: M22	
	Port 41: M16		Port 4: M16	Port 4: M16	
Repair Kit	EKMM.2.2	Repair Kit	EKMM.2.3	Repair Kit	EKMM.2.3

23.07.1003		23.07.1004		---		23.07.1002	
Alternative Part No	AC574BYW	Alternative Part No	AC586AY	Alternative Part No	AC575A	Alternative Part No	AC577A
Port 1 & 2: M22 Voss		All Ports: M22		Ports 1,2&3: M22		Ports 1 & 2: M22 Voss	
Port 4: M16 Voss				Port 4: M16		Port 4: M16 Voss	
Repair Kit	EKMM.2.3	Repair Kit	---	Repair Kit	---	Repair Kit	EKMM.3.1

23.07.1001		23.01.7000		23.01.7000	
Alternative Part No	AC577B	Alternative Part No	AC586A	Alternative Part No	AC586AAX
Port 1: M22		All Ports: M22		All Ports: M22	
Ports 2 & 4: M16					
Repair Kit	EKMM.3.1	Repair Kit	EKMM.3	Repair Kit	EKMM.3

RELAY VALVES - WABCO



---		---		23.01.1520		23.01.1531	
							
Alternative Part No	4710030200	Alternative Part No	4710030240	Alternative Part No	4710050200	Alternative Part No	4710055310
All Ports: M22		All Ports: M22		All Ports: M22		All Ports: M22	
Repair Kit	---	Repair Kit	---	Repair Kit	EKWA.30	Repair Kit	EKWA.30 EKWA.30.1

---		23.01.7000		23.01.7001		---	
							
Alternative Part No	4730110000	Alternative Part No	4730170000	Alternative Part No	4730170010	Alternative Part No	4750190000
All Ports: M22		All Ports: M22		All Ports: M22		All Ports: M22 Voss	
Repair Kit	---	Repair Kit	EKWA.33.1 or EKWA.57	Repair Kit	---	Repair Kit	EKWA.33.1

23.01.8004		23.01.8005		23.01.8009		---	
							
Alternative Part No	4802020040	Alternative Part No	4802020050	Alternative Part No	4802020090	Alternative Part No	4802020120
Port 1 & 2: M22 Voss Port 4: M16 Voss Exhaust: Silencer		Port 1 & 2: M22 Voss Port 4: M16 Voss Exhaust: Silencer		Port 1 & 2: M22 Voss Port 4: M16 Voss Exhaust: Silencer		Port 1 & 2: M22 Voss Port 4: M16 Voss Exhaust: Silencer	
Repair Kit	EKWA.58.9 or 90.01.2050	Repair Kit	EKWA.58.9 or 90.01.2050	Repair Kit	EKWA.58.9	Repair Kit	EKWA.58.9 or 90.01.2050

RELAY VALVES

RELAY VALVES - WABCO

<p>23.01.9001</p>  <p>Alternative Part No 4802050010</p> <p>Port 1 & 2: M22 Voss Port 4: M16 Voss Exhaust: Rubber Flap</p> <p>Repair Kit EKWA.5714</p>	<p>23.01.9010</p>  <p>Alternative Part No 4802050100</p> <p>Port 1: M16 Port 2: M22 Port 4: M16</p> <p>Repair Kit EKWA.56.C or 26.01.H012</p>	<p>23.01.9103</p>  <p>Alternative Part No 4802051030</p> <p>Port 1 & 2: M22 Voss Port 4: M16 Voss Exhaust: Rubber Flap</p> <p>Repair Kit EKWA.5714</p>	<p>23.01.9106</p>  <p>Alternative Part No 4802051040</p> <p>Port 1 & 2: M22 Voss Port 4: M16 Voss Exhaust: Span On</p> <p>Repair Kit EKWA.5714</p>
<p>23.01.9106</p>  <p>Alternative Part No 4802051060</p> <p>Port 1 & 2: M22 Voss Port 4: M16 Voss Exhaust: Span On</p> <p>Repair Kit EKWA.5714</p>	<p>23.01.A001</p>  <p>Alternative Part No 4802070010</p> <p>Manufacturer changed the connectors on this item: 1 x 8946011342 & 1 x 8946011322 may be needed</p> <p>Repair Kit EKWA.5715</p>	<p>23.01.2000</p>  <p>Alternative Part No 97100200000</p> <p>All Ports: M22</p> <p>Repair Kit SEKWA.56.C EKWA.56.C</p>	<p>23.01.2150</p>  <p>Alternative Part No 9710021500</p> <p>All Ports: M22</p> <p>Repair Kit SEKWA.56.C EKWA.56.C</p>
<p>23.01.2152</p>  <p>Alternative Part No 9710021520</p> <p>Port 1 & 2: M16 & M22 Port 4: M16</p> <p>Repair Kit SEKWA.56.C EKWA.56.C</p>	<p>23.01.2150</p>  <p>Alternative Part No 9710021550</p> <p>All Ports: M22</p> <p>Repair Kit SEKWA.56.C EKWA.56.C</p>	<p>23.01.2157</p>  <p>Alternative Part No 9710021570</p> <p>Port 1 & 2: M16 & M22 Port 4: M16</p> <p>Repair Kit SEKWA.56.C EKWA.56.C</p>	<p>23.01.2200</p>  <p>Alternative Part No 9710022000</p> <p>All Ports: M22</p> <p>Repair Kit SEKWA.56.C EKWA.56.C</p>

RELAY VALVES - WABCO

23.01.2300	
	
Alternative Part No	9710023000
Port 1 & 2: M22 Port 4: M16	
Repair Kit	EKWA.56.3

23.01.2301	
	
Alternative Part No	9710023010
Port 1 & 2: M22 Port 4: M16	
Repair Kit	EKWA.56.3

23.01.2303	
	
Alternative Part No	9710023030
All Ports: M22	
Repair Kit	EKWA.56.3

23.01.2304	
	
Alternative Part No	9710023040
All Ports: M22	
Repair Kit	EKWA.56.3

23.01.2307	
	
Alternative Part No	9710023070
All Ports: M22	
Repair Kit	EKWA.56.3

23.01.2308	
	
Alternative Part No	9710023080
All Ports: M22	
Repair Kit	EKWA.56.3

23.01.2530	
	
Alternative Part No	9710025300
All Ports: M22	
Repair Kit	EKWA.56.C or 26.01.H013

23.01.2531	
	
Alternative Part No	9710025310
All Ports: M22	
Repair Kit	EKWA.56.C or 26.01.H013

23.01.2532	
	
Alternative Part No	9710025320
All Ports: M22	
Repair Kit	EKWA.56.C or 26.01.H013

23.01.2533	
	
Alternative Part No	9710025330
All Ports: M22	
Repair Kit	EKWA.56.C or 26.01.H013

23.01.2570	
	
Alternative Part No	9710025700
All Ports: M22	
Repair Kit	EKWA.56.C or EKWA.36

23.01.2620	
	
Alternative Part No	9710026200
All Ports: M22	
Repair Kit	EKWA.56.C, EKWA.36 or 26.01.H012

RELAY VALVES

RELAY VALVES - WABCO

23.01.2700		23.01.2701		---		R23.01.2802	
Alternative Part No	9710027000	Alternative Part No	9710027010	Alternative Part No	9710027040	Alternative Part No	9710028020
Port 1 & 2:M22 Port 4:M16		Port 1: M16 Port 2: M22 Port 4: M16		Port 1: M16 Port 2: M22 Port 4: M16		Port 1: M16 Port 2: M22 Port 4: M16	
Repair Kit	EKWA.56.C or 26.01.H013	Repair Kit	EKWA.56.C or 26.01.H012	Repair Kit	EKWA.56.C or 26.01.H012	Repair Kit	EKWA.56.3

23.01.2805		23.01.3010		23.01.3020		23.01.3210	
Alternative Part No	9710028050	Alternative Part No	9730010100	Alternative Part No	9730010200	Alternative Part No	9730012100
Port 1: M16 Port 2: M22 Port 4: M16		All Ports: M22		Port 1: M16 Port 2: M22 Port 4: M16		All Ports: M22	
Repair Kit	EKWA.56.3, 9710029212 or EKWA.56.4	Repair Kit	EKWA.33.1 or EKWA.57	Repair Kit	EKWA.33.1 or EKWA.57	Repair Kit	EKWA.33.1 or EKWA.57

23.01.3211		23.01.3221		23.01.4000		23.01.4002	
Alternative Part No	9730012110	Alternative Part No	9730012210	Alternative Part No	9730030000	Alternative Part No	9730030020
All Ports: M22		Port 1 & 3: M22 Port 2 & 4:M16		All Ports: M22		All Ports: M22	
Repair Kit	EKWA.33.1 or EKWA.57	Repair Kit	EKWA.33.1 or EKWA.57	Repair Kit	EKWA.58.7	Repair Kit	EKWA.58.7

RELAY VALVES - WABCO

23.01.4006	
	
Alternative Part No	9730030060
All Ports: M22	
Repair Kit	EKWA.58.7 and 90.01.2050

23.01.4007	
	
Alternative Part No	9730030070
All Ports: M22	
Repair Kit	EKWA.58.7

23.01.4008	
	
Alternative Part No	9730030080
All Ports: M22	
Repair Kit	EKWA.58.7 and 90.01.2050

23.01.4010	
	
Alternative Part No	9730030100
All Ports: M22 Voss	
Repair Kit	EKWA.58.7 or 90.01.2050

23.01.4012	
	
Alternative Part No	9730030120
All Ports: M22 Voss	
Repair Kit	EKWA.58.7 or 90.01.2050

23.01.5000	
	
Alternative Part No	9730060000
Port 1: M22 Port 2 & 4: M16 Port 3: Snap-on	
Repair Kit	EKWA.57.3

23.01.5001	
	
Alternative Part No	9730060010
Port 1 & 2: M22 Voss Port 4: M16 Voss Port 3: Snap-on	
Repair Kit	EKWA.57.3

23.01.5003	
	
Alternative Part No	9730060030
Port 1 & 2: M22 Voss Port 4: M16 Voss	
Repair Kit	EKWA.57.3 and 90.01.2050

23.01.6000	
	
Alternative Part No	9730110000
Port 1 & 2: M22 Port 4: M16 Port 3: Snap-on	
Repair Kit	EKWA.57.5

23.01.6001	
	
Alternative Part No	9730110010
Port 1 & 2: M22 Voss Port 4: M16 Voss Port 3: Snap-on	
Repair Kit	EKWA.57.5

23.01.6002	
	
Alternative Part No	9730110020
Port 1,2 & 3: M22 Port 4: M16	
Repair Kit	EKWA.57.5

23.01.6004	
	
Alternative Part No	9730110040
Port 1 & 2: M22 Voss Port 4: M16 Voss Port 3: With silence	
Repair Kit	EKWA.57.5 and 90.01.2050

RELAY VALVES

RELAY VALVES - WABCO

23.01.6008		23.01.6009		23.01.6010		23.01.6011	
Alternative Part No	9730110080	Alternative Part No	9730110090	Alternative Part No	9730110100	Alternative Part No	9730110110
Port 1 & 2: M22 Port 4:M22 Port 3:With Silencer		Port 1 & 2: M22 Voss Port 4: M16 Voss Port 3: Snap-on		Port 1 & 2: M22 Port 4:M16 Port 3:With Silencer		Port 1 & 2:M22 Port 4:M16 Port 3:Snap-on	
Repair Kit	EKWA.57.5 and 90.01.2050	Repair Kit	EKWA.57.5 and 90.01.2050	Repair Kit	EKWA.57.5 and 90.01.2050	Repair Kit	EKWA.57.5

23.01.6014		23.01.6050		23.01.6067		23.01.6100	
Alternative Part No	9730110140	Alternative Part No	9730110500	Alternative Part No	9730110670	Alternative Part No	730111000
Port 1 & 2: M22 Voss Port 4: M16 Voss Port 3: Snap-on		Port 1 & 3: M22 Port 2: M16 Port 4:M16		Port 1 & 2: M22 Port 4:M16 Voss Port 3:With Silencer		Port 1 & 2:M22 Port 3 & 4:M16 Port 3:with silencer	
Repair Kit	EKWA.57.5	Repair Kit	EKWA.57.7	Repair Kit	EKWA.57.7	Repair Kit	EKWA.57.5 and 90.01.2050

23.01.6101		23.01.6107		23.01.6105		23.01.6106	
Alternative Part No	9730111010	Alternative Part No	9730111040	Alternative Part No	9730111050	Alternative Part No	9730111060
Port 1 & 2: M22 Port 4:M16 Port 3:With Silencer		Port 1 & 2: M22 Port 3 & 4: M16 Port 3:Snap-on		Port 1 & 2:M22 Port 41 & 42:M16 Port 3:Snap-on		Port 1 & 2:M22 Voss Port 41 & 42:M16 Voss Port 3:With Silencer	
Repair Kit	EKWA.57.7	Repair Kit	EKWA.57.5 and 90.01.2050	Repair Kit	EKWA.57.7	Repair Kit	EKWA.57.5 and 90.01.2050

RELAY VALVES - WABCO

23.01.6107	
	
Alternative Part No	973011070
Port 1 & 2: M22 Voss Port 41 & 42: M16 Voss Port 3: With Silencer	
Repair Kit	EKWA.57.5 and 90.01.2050

23.01.6109	
	
Alternative Part No	973011090
Port 1 & 2: M22 Voss Port 41 & 42: M16 Voss Port 3: With Silencer	
Repair Kit	EKWA.57.5 and 90.01.2050

23.01.6110	
	
Alternative Part No	973011100
Port 1 & 2: M22 Voss Port 41 & 42: M16 Voss Port 3: With Silencer	
Repair Kit	EKWA.57.5 and 90.01.2050

23.01.6200	
	
Alternative Part No	9730112000
Port 1 & 2: M22 Voss Port 4: M16 Voss Exhaust: Snap-on	
Repair Kit	EKWA.57.7

23.01.6201	
	
Alternative Part No	9730112010
Port 1: M22 Port 2 & 4: M16 Exhaust: Snap-on	
Repair Kit	EKWA.57.7

23.01.6203	
	
Alternative Part No	9730112030
Port 1 & 2: M22 Port 4: M16 Exhaust: Snap-on	
Repair Kit	EKWA.57.7

23.01.6205	
	
Alternative Part No	9730112050
Port 1 & 2: M22 Voss Port 4: M16 Voss Port 3: With silencer	
Repair Kit	EKWA.57.5 and 90.01.2050

23.01.6206	
	
Alternative Part No	9730112060
Port 1 & 2: M22 Voss Port 4: M16 Voss Port 3: With silencer	
Repair Kit	EKWA.57.5 and 90.01.2050

23.01.6208	
	
Alternative Part No	9730112080
Port 1: M22 Voss Port 2 & 4: M16 Voss Port 3: With silencer	
Repair Kit	EKWA.57.7 or 90.01.2050



23.01.6250	
	
Alternative Part No	9730112500
Port 1 & 2: M22 Voss Port 41 & 42: M16 Voss Port 3: Snap-on	
Repair Kit	EKWA.57.7

23.01.6300	
	
Alternative Part No	9730113000
Port 1, 2 & 3: M22 Voss Port 4: M16 Voss Exhaust: Snap-on	
Repair Kit	EKWA.57.12

For Silencers please see page 90.8

RELAY VALVES

EBS ELECTRO VALVE CABLES

EBS Part No	Alternative Part No	Unit	Plug Images	
EKWA.110.3	8946011322			
EKWA.110.20	Adaptor Cable From Square Plug Into DIN Bayonet			
EKWA.110.21	Adaptor Cable From Square Plug Into Round Female Plug			
EKWA.110.32	8946011332			
EKWA.110.82	8946011382			
EKWA.110.92	8946011392			
EKWA.110.212	9710029212			



EBS BENDIX REPAIR KITS



EBS BOSCH REPAIR KITS



EBS HALDEX REPAIR KITS



RELAY VALVES

EBS KNORR BREMSE REPAIR KITS

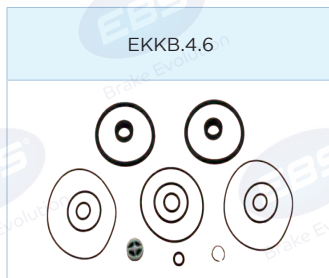

RELAY VALVES KITS - CLAYTON DEWANDRE



RELAY VALVES KITS - MAGNETI MARELLI



RELAY VALVES KITS - WABCO



RELAY VALVES KITS - WABCO

EKWA.57.3

When used on 9710025330
this kit is for the Relay Valve Only

EKWA.57.5

EKWA.57.7

EKWA.57.12

EKWA.57.14

EKWA.57.15

EKWA.58.7

EKWA.58.9

26.01.H012

26.01.H013

90.01.2050

RELAY VALVES

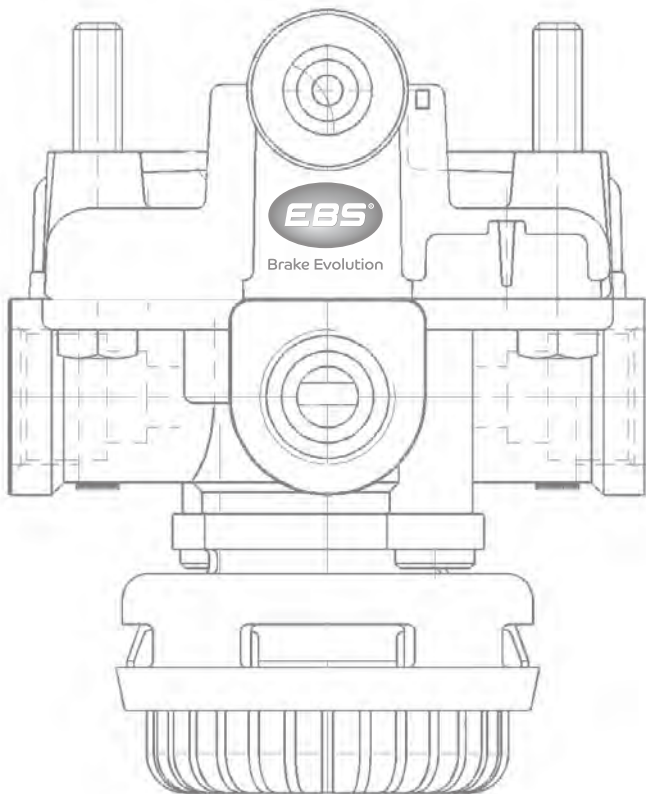
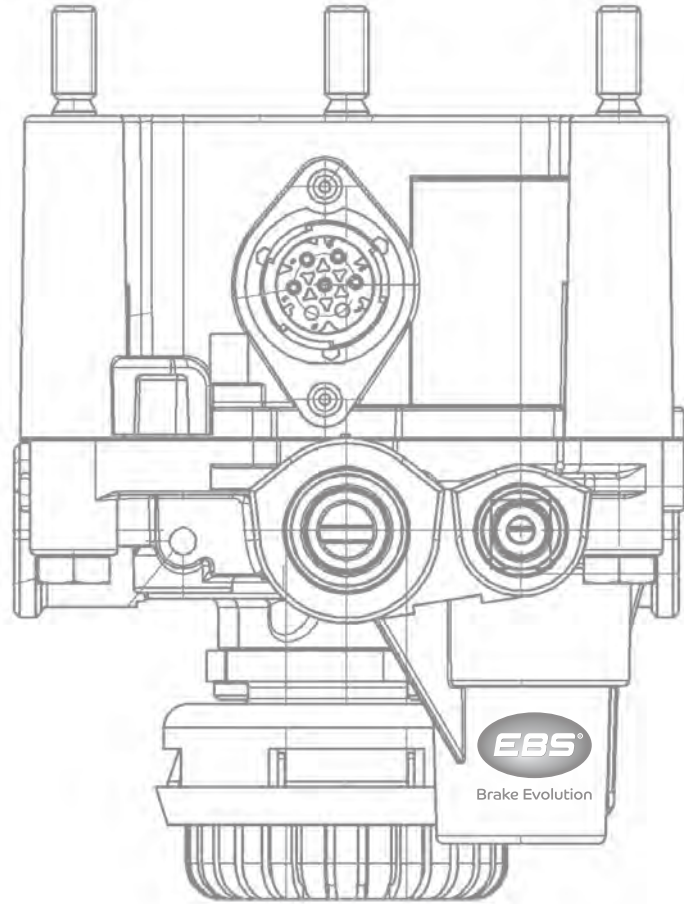

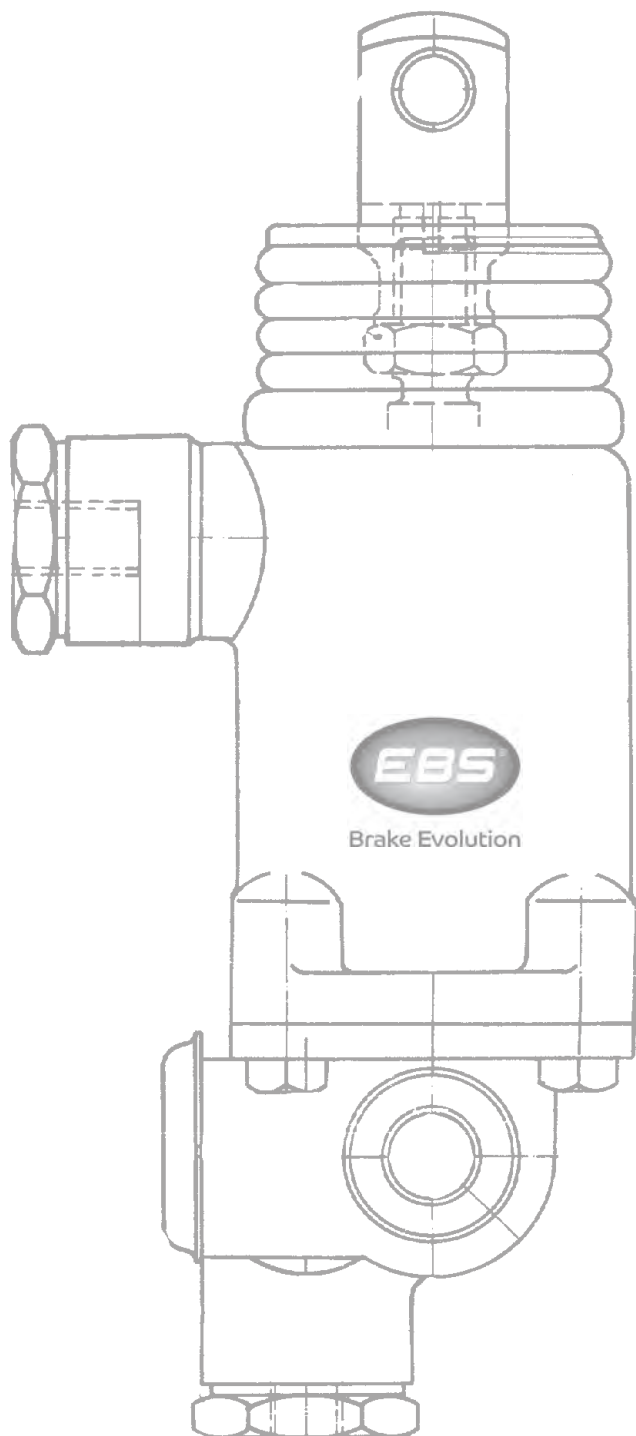

EBS OPERATING & POSITION CYLINDERS - BERTOCCHI

---		
Alternative Part No	C3110002	
Locking Cylinder Piston: 28mm dia		
Repair Kit	---	

EBS OPERATING & POSITION CYLINDERS - BOSCH

---		---		---		---	
							
Alternative Part No	0482005018000	Alternative Part No	0482006006000	Alternative Part No	0482018002000	Alternative Part No	0482020002000
Operating Cylinder Piston: 30mm dia Stroke: 80mm		Operating Cylinder Piston: 35mm dia Stroke: 85mm		Operating Cylinder Piston: 35mm dia Stroke: 85mm		Operating Cylinder Piston: 18mm dia Stroke: 30mm	
Repair Kit	---	Repair Kit	---	Repair Kit	---	Repair Kit	---

EBS OPERATING & POSITION CYLINDERS - HALDEX

---		---		---		---	
							
Alternative Part No	3400034201	Alternative Part No	340005001	Alternative Part No	340011001 4210050200 BZ1700	Alternative Part No	340079003
Piston Cylinder Piston: 90mm dia Stroke: 32mm Length: 156mm		Piston Cylinder Piston: 100mm dia Stroke: 135mm Length: 300mm		Piston Cylinder Piston: 140mm dia Stroke: 155mm Length: 355mm		Piston Cylinder Piston: 150mm dia Stroke: 60mm Length: 199mm	
Repair Kit	EKGH.10	Repair Kit	---	Repair Kit	---	Repair Kit	---

EBS OPERATING & POSITION CYLINDERS - HALDEX

---		---		---	
					
Alternative Part No	341011021	Alternative Part No	341032011	Alternative Part No	541033011
Control Cylinder Piston: 35mm dia Stroke: 50mm Length: 193mm		Control Cylinder Piston: 35mm dia Stroke: 35mm Length: 132mm		Piston Cylinder Piston: 80mm dia Stroke: 70mm Length: 275mm	
Repair Kit	---	Repair Kit	---	Repair Kit	---

EBS OPERATING & POSITION CYLINDERS - KNORR BREMSE

---		24.02.0195		24.02.0198		---	
							
Alternative Part No	K009936 SC4A	Alternative Part No	K010195 SC1C	Alternative Part No	K010198 SC2CK	Alternative Part No	SZ1117 I63748
Operating Cylinder		Operating Cylinder Piston: 36mm dia Stroke: 67mm		Operating Cylinder Piston: 36mm dia Stroke: 97mm		Operating Cylinder Piston: 24mm dia Stroke: 50mm	
Repair Kit	---	Repair Kit	---	Repair Kit	---	Repair Kit	---

24.02.5564		---		24.02.1399	
					
Alternative Part No	I85564 SZ1159	Alternative Part No	SZ1211 SEB00014	Alternative Part No	AC399A
Operating Cylinder		Operating Cylinder		Operating Cylinder Piston: 30mm dia Stroke: 40mm	
Repair Kit	---	Repair Kit	---	Repair Kit	---

OPERATING & POSITION CYLINDERS

EBS OPERATING & POSITION CYLINDERS - VOLVO

24.30.1000	
Alternative Part No	1616808
Operating Cylinder	
Repair Kit	---

24.30.1001	
Alternative Part No	22889891
Operating Cylinder	
Repair Kit	---

EBS OPERATING & POSITION CYLINDERS - WABCO

24.01.1025	
Alternative Part No	4214100250
Operating Cylinder Piston: 30mm dia Stroke: 50mm Length: 193mm	
Repair Kit	---

24.01.1039	
Alternative Part No	4214100390
Operating Cylinder Piston: 35mm dia Stroke: 25mm Length: 107mm	
Repair Kit	---

Alternative Part No	4214100410
Operating Cylinder Piston: 30mm dia Stroke: 45mm Length: 172mm	
Repair Kit	---

Alternative Part No	4214100590
Operating Cylinder Piston: 30mm dia Stroke: 30mm Length: 153mm	
Repair Kit	---

Alternative Part No	4214110210
Operating Cylinder Piston: 35mm dia Stroke: 65mm Length: 185mm	
Repair Kit	---

Alternative Part No	4214110940
Operating Cylinder Piston: 35mm dia Stroke: 85mm Length: 228mm	
Repair Kit	---

24.01.2020	
Alternative Part No	4214113000
Operating Cylinder Piston: 30mm dia Stroke: 45mm Length: 172mm	
Repair Kit	---

24.01.2301	
Alternative Part No	4214113010
Operating Cylinder Piston: 35mm dia Stroke: 78mm Length: 187mm	
Repair Kit	---

Alternative Part No	4214113060
Operating Cylinder Piston: 35mm dia Stroke: 85mm Length: 227mm	
Repair Kit	---

Alternative Part No	4214113080
Operating Cylinder Piston: 35mm dia Stroke: 85mm Length: 227mm	
Repair Kit	---

Alternative Part No	4214113110
Operating Cylinder Piston: 35mm dia Stroke: 73mm Length: 187mm	
Repair Kit	---

24.01.2314	
Alternative Part No	4214113140
Operating Cylinder Piston: 35mm dia Stroke: 60mm Length: 180mm	
Repair Kit	---

EBS OPERATING & POSITION CYLINDERS - WABCO

24.01.2316		Alternative Part No	4214113160	Operating Cylinder Piston: 35mm dia Stroke: 60mm Length: 180mm	Repair Kit	---
24.01.2500		Alternative Part No	4214115000	Operating Cylinder Piston: 50mm dia Stroke: 53mm Length: 180.5mm	Repair Kit	---
24.01.3000		Alternative Part No	4214120000	Operating Cylinder Piston: 50mm dia Stroke: 65mm Length: 221mm	Repair Kit	EKWA.2.2
24.01.9003		Alternative Part No	4214290030 SZ1114	Operating Cylinder Piston: 28mm dia Stroke: 48mm Length: 171mm	Repair Kit	---
---		Alternative Part No	4214410030	Operating Cylinder Piston: 35mm dia Stroke: -32/+50 Length: 172mm	Repair Kit	EKWA.1.1
24.01.4000		Alternative Part No	4214420000	Operating Cylinder Piston: 35mm dia Stroke: 40mm Length: 163mm	Repair Kit	---
24.01.4008		Alternative Part No	4214420080	Operating Cylinder Piston: 35mm dia Stroke: 40mm Length: 193mm	Repair Kit	---
---		Alternative Part No	4214420180	Operating Cylinder Piston: 35mm dia Stroke: 60mm Length: 226mm	Repair Kit	---
24.01.6000		Alternative Part No	4214450000	Operating Cylinder Piston: 32mm dia Stroke: 52mm Length: 169.5mm	Repair Kit	EKWA.2.3
24.01.7010		Alternative Part No	4220100100 00026035630080	Gearbox Multi Position Cylinder (DAF). Piston: 54mm dia Stroke: 65mm	Repair Kit	EKWA.1.1
24.01.7012		Alternative Part No	0002604663 1517945 4220100120 81327356041	Gearbox Multi Position Cylinder (DAF / MAN / MERC) Piston: 62mm dia. Stroke: 65mm	Repair Kit	EKWA.1.1
24.01.7014		Alternative Part No	4220100140	Gearbox Multi Position Cylinder Piston: 62mm dia Stroke: 65mm	Repair Kit	EKWA.1.1
24.01.8402		Alternative Part No	4228024020 0007633001	Gearbox Multi Position Cylinder (MERCEDES) Piston: 60mm dia. Stroke: 180mm Length: 380mm	Repair Kit	EKWA.2
---		Alternative Part No	4228140000	Door Cylinder Piston: 50mm dia Stroke: 140mm Length: 288mm	Repair Kit	---

OPERATING & POSITION CYLINDERS

EBS SPRING BRAKE CYLINDERS - WABCO

	24.01.9004	
Alternative Part No	4253110040	
	Piston: 65mm dia Stroke: 50mm	
Repair Kit	EKWA.10.1	

EBS HALDEX REPAIR KITS



EBS WABCO REPAIR KITS



SLACK ADJUSTERS

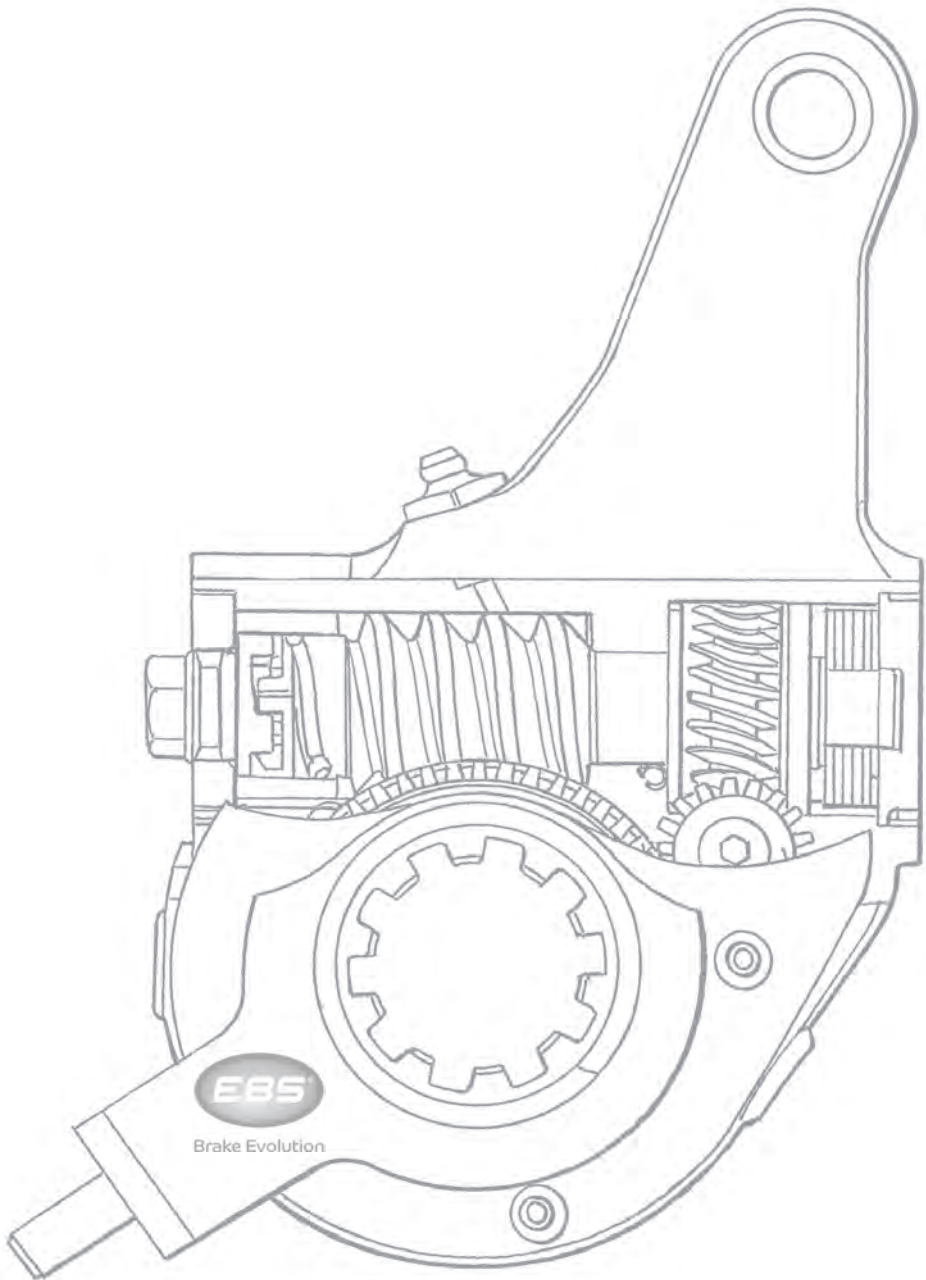

Why Choose EBS Automatic Slack Adjusters:

- Comprehensive Range with ex-stock availability.
- Competitive pricing.
- All EBS Slack Adjusters will directly replace numerous other brands.
- Greater interchangeability gives the ability to stock fewer part numbers.
- Higher versatility - less limitation on the control arm installation angle.
- Cost saving - EBS offers an “Intelligent Automatic Slack Adjuster” with the control arm automatically finding the initial position, reducing set up times.

Testing:

- Durability Testing.
- Torsional Fatigue Strength Testing.
- Waterproof Testing.

Conformity:

- ISO/TS16949:2009.
- ISO/9001-2008.
- First purpose built testing facility of it's kind.
- New application patent certificates.
- Invention certificate for Automatic Adjusting Device.



High quality brass bushes.

All EBS Automatic Slack Adjusters are fitted with grease nipples.

Fully branded.

EBS Part Reference for ease of identification and traceability.

High quality strengthened cover plate and fixing screws.

Intelligent Control Arm*
- Automatically finds its initial position.

*Only on the Self Adjusting Versions

TRUCK & BUS FITMENT POSITION GUIDE

FOR TRAILER APPLICATIONS - SEE PAGES 25.30 TO 25.36

Where possible EBS has detailed to which side of the vehicle the EBS slack adjuster reference is fitted.

The information we have provided within this section should only be used as a guide. The guaranteed way of selecting the correct replacement EBS product is to identify the actual reference of the item that is being removed from the vehicle itself.

Please note - as the information is not always available this is only an indication of the applications suited for each EBS reference.













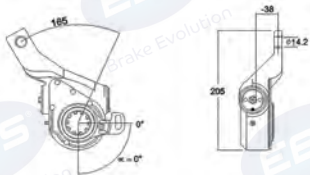

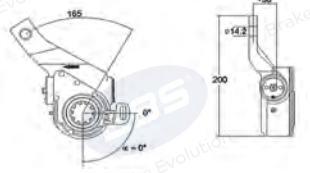

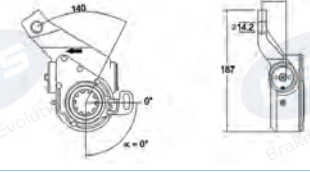

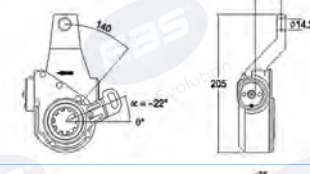
1 = Right Hand Side Of Vehicle Fitment

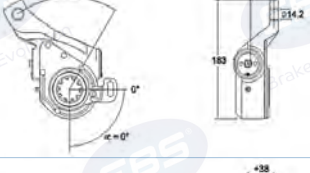
2 = Left Hand Side Of Vehicle Fitment

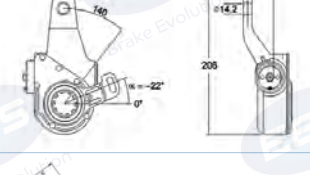
EBS AUTOMATIC SLACK ADJUSTERS - TRUCK & BUS - DAF

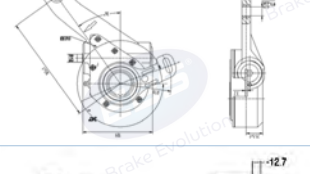

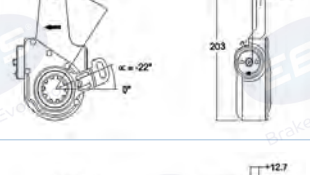

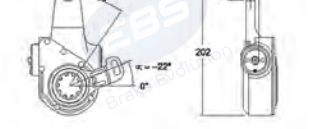





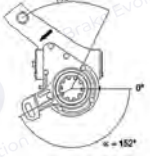

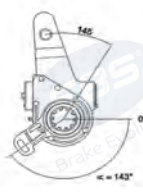

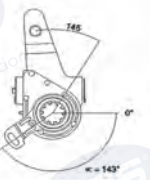
EBS Part No.	Application	Fitment Position (Chart - P25.4)	Spline Teeth No	Alternative	Opposite Hand	Image		
EBS2010	DAF TRUCK OE: 0159556	2	10	4W2010	EBS2015			
		Left		KB2010				
				72523				
EBS2015	DAF TRUCK OE: 0159557	1	10	4W2015	EBS2010			
		Right		KB2015				
				72524				
EBS2020	DAF TRUCK OE: 0159589	1	10	4W2020	EBS2025			
		Right		KB2020				
				72538				
EBS2025	DAF TRUCK OE: 0159590	2	10	4W2025	EBS2020			
		Left		KB2025				
				72539				
EBS2030	DAF TRUCK & BUS OE: 0537538	1 & 2	10	4W2030	N/A			
		Right & Left		KB2030				
				72534				

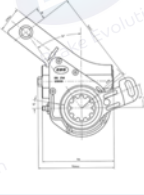
EBS AUTOMATIC SLACK ADJUSTERS - TRUCK & BUS - DAF

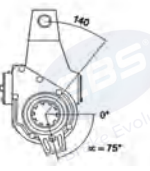

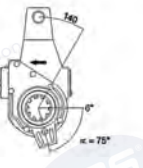

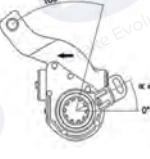

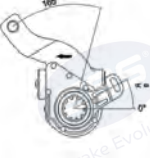



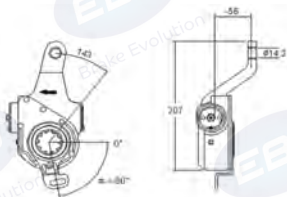

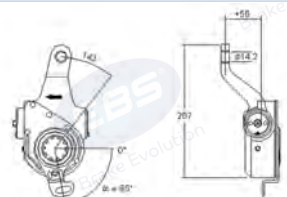

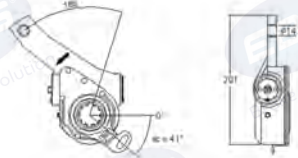
EBS Part No.	Application	Fitment Position (Chart - P25.4)	Spline Teeth No	Alternative	Opposite Hand	Image	
EBS2035	DAF TRUCK OE: 0159562	1 Right	10	4W2035	EBS2105		
				KB2035			
				72543			
EBS2105	DAF TRUCK OE: 0159561	2 Left	10	4W2105	EBS2035		
				KB2105			
				72542			
EBS2110	DAF TRUCK & BUS OE: 0159587	2 Left	10	4W2110	EBS2120		
				KB2110			
				72536			
EBS2115	DAF TRUCK & BUS OE: 0159558	2 Left	10	4W2115	EBS2125		
				KB2115			
				72525			
EBS2120	DAF TRUCK & BUS OE: 0159588	1 Right	10	4W2120	EBS2110		
				KB2120			
				72537			
EBS2125	DAF TRUCK & BUS OE: 0159559	1 Right	10	4W2125	EBS2115		
				KB2125			
				72526			
EBS2305	DAF TRUCK OE: 0159591	1+2 Right + Left	10	4W2305	N/A		
				KB2305			
				72540C			
EBS2400	DAF TRUCK & BUS OE: 0740321	2 Left	10	4W2400	EBS2425		
				KB2400			
				72608			
EBS2425	DAF TRUCK & BUS OE: 0740322	1 Right	10	4W2425	EBS2400		
				KB2425			
				72609			

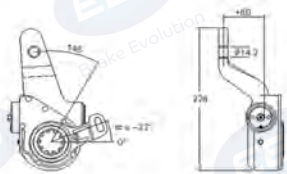
SLACK ADJUSTERS

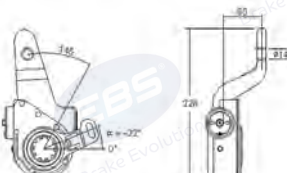
EBS AUTOMATIC SLACK ADJUSTERS - TRUCK & BUS - DAF

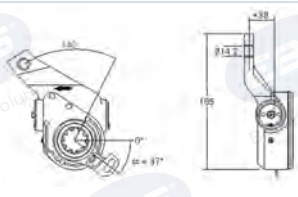
EBS Part No.	Application	Fitment Position (Chart - P25.4)	Spline Teeth No	Alternative	Opposite Hand	Image	
EBS2515	DAF BUS OE: 0159565	1 & 2	10	4W2515	N/A		
		Right & Left		KB2515			
				72535			
EBS2725	DAF TRUCK OE: 1263485	2	10	4W2725	EBS2730		
		Left		KB2725			
				72886			
EBS2730	DAF TRUCK OE: 1263486	1	10	4W2730	EBS2725		
		Right		KB2730			
				72887			
EBS2760	DAF TRUCK OE: 159560	1 & 2	10	4W2760	N/A		
		Right & Left		KB2760			
				72530C			
EBS2816	DAF BUS OE: N/A	2	10	4W3000	EBS3005		
		Left		KB3000			
				72816			
EBS3005	DAF BUS OE: N/A	1	10	4W3005	EBS2816		
		Right		KB3005			
				72815			
EBS3425	DAF TRUCK OE: 1282111	2	10	4W3425	EBS3430		
		Left		KB3425			
				79024			
EBS3430	DAF TRUCK OE: 1282112	1	10	4W3430	EBS3425		
		Right		KB3430			
				73025			

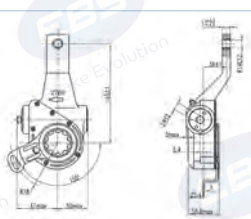
EBS AUTOMATIC SLACK ADJUSTERS - TRUCK & BUS - DAF

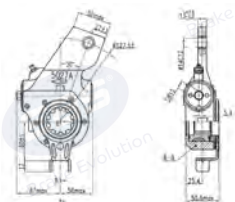
EBS Part No.	Application	Fitment Position (Chart - P25.4)	Spline Teeth No	Alternative	Opposite Hand	Image	
EBS3655	DAF TRUCK OE: 0159563	2	10	4W3655	EBS3660		
		Left		KB3655			
		72544					
EBS3660	DAF TRUCK OE: 0159564	1	10	4W3660	EBS3655		
		Right		KB3660			
		72545					
EBS3665	DAF TRUCK OE: 0159576	1 & 2	10	4W3665	N/A		
		Right & Left		KB3665			
		72547					
EBS3700	DAF TRUCK OE: 0755616	2	10	4W3700	EBS3705		
		Left		KB3700			
				72704			
EBS3705	DAF TRUCK OE: 0755617	1	10	4W3705	EBS3700		
		Right		KB3705			
				72705			
EBS3790	DAF BUS OE: 0097774	1	10	4W3790	N/A		
		Right		KB3790			
				72679			
EBS4305	DAF OE: 292924	---	10	4W4305	---		
		---		---			
		---		72532			
25.80.0133	DAF OE: 1511183	---	10	80133C	N/A		
		---		6Y6600			

SLACK ADJUSTERS

EBS AUTOMATIC SLACK ADJUSTERS - TRUCK & BUS - FODEN







EBS Part No.	Application	Fitment Position (Chart - P25.4)	Spline Teeth No	Alternative	Opposite Hand	Image	
EBS2170	FODEN TRUCK OE: 2700021000	1 & 2	28	4W2170	N/A		
		Right & Left		KB2170			
				72181			
EBS2235	FODEN TRUCK OE: 2700020000	1 & 2	28	4W2235	N/A		
		Right & Left		KB2235			
				72180			
EBS3300	FODEN TRUCK OE: 2700040000	1 & 2	28	4W3300	N/A		
		Right & Left		KB3300			
				72939			
EBS3460	FODEN TRUCK OE: N/A	1 & 2	10	4W3460	N/A		
		Right & Left		KB3460			
				72568C			
EBS4135	FODEN TRUCK OE: N/A	1 & 2	10	4W4135	N/A		
		Right & Left		79133C			

EBS4215	FODEN TRUCK OE: N/A	1	28	4W4215	N/A		
		Right & Left		KB4215			
				79682			

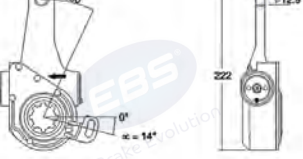
EBS AUTOMATIC SLACK ADJUSTERS - TRUCK & BUS - HINO

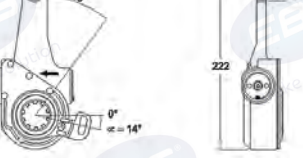
EBS Part No.	Application	Fitment Position (Chart - P25.4)	Spline Teeth No	Alternative	Opposite Hand	Image	
EBS2405	HINO TRUCK OE: 474801790	1	19	4W2405	EBS2410		
				KB2405			
		Front Right		12254			
EBS2410	HINO TRUCK OE: 474901180	2	19	4W2410	EBS2405		
				KB2410			
		Front Left		12255			
EBS2415	HINO TRUCK OE: 474801801	1 & 2	19	4W2415	N/A		
				KB2415			
		Rear Right & Left		12256			

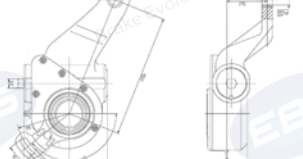
EBS AUTOMATIC SLACK ADJUSTERS - TRUCK & BUS - IVECO

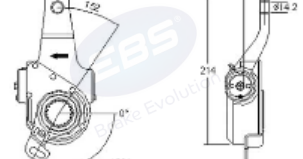
EBS Part No.	Application	Fitment Position (Chart - P25.4)	Spline Teeth No	Alternative	Opposite Hand	Image	
EBS2745	IVECO TRUCK OE: 4692759	1 & 2	8	4W2745	N/A		
				KB2745			
		Right & Left		78010			
EBS3495	IVECO BUS OE: 0178529	1 & 2	10	4W3495	N/A		
				KB3495			
		Right & Left		70903C			
EBS3645	IVECO BUS OE: 3231273	1	19	4W3645	EBS3650		
				KB3645			
		Right		72929C			
EBS3650	IVECO BUS	2	19	---	EBS3645		

		Left		72930C			

SLACK ADJUSTERS









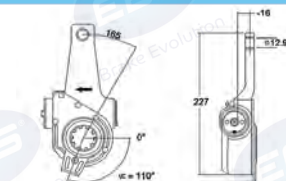

EBS AUTOMATIC SLACK ADJUSTERS - TRUCK & BUS - KASSBOHRER

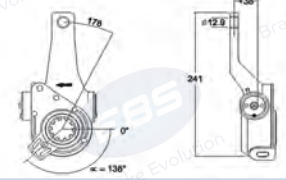
EBS Part No.	Application	Fitment Position (Chart - P25.4)	Spline Teeth No	Alternative	Opposite Hand	Image	
EBS2085	KASSBOHRER BUS OE: 8238000835	1 & 2 Right & Left	37	4W2085	N/A		
				KB2085			
				72758C			
EBS2975	KASSBOHRER BUS OE: 82850002140	2 Left	19	4W2975	EBS3575		
				KB2975			
				72592C			
EBS3255	KASSBOHRER BUS OE: 82830005520	2 Left	19	4W3255	EBS3260		
				KB3255			
				72014			
EBS3260	KASSBOHRER BUS OE: 82830005530	1 Right	19	4W3260	EBS3255		
				KB3260			
				72015			
EBS3575	KASSBOHRER BUS OE: 82850002130	1 Right	19	4W3575	EBS2975		
				KB3575			
				72591C			
EBS3680	KASSBOHRER BUS OE: 82850000900	2 Left	19	4W3680	EBS3685		
				KB3680			
				79040C			
EBS3685	KASSBOHRER BUS OE: 82850000890	1 Right	19	4W3685	EBS3680		
				KB3685			
				79041C			

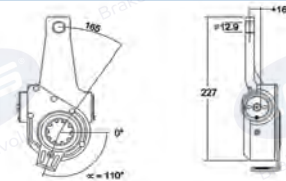
EBS AUTOMATIC SLACK ADJUSTERS - TRUCK & BUS - LIAZ

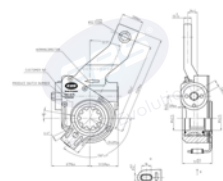
EBS Part No.	Application	Fitment Position (Chart - P25.4)	Spline Teeth No	Alternative	Opposite Hand	Image	
EBS3900	LIAZ BUS OE: N/A	1 & 2 Right & Left	20	4W3900	N/A		
				KB3900			

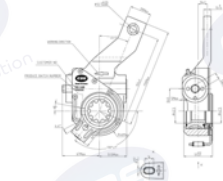
EBS AUTOMATIC SLACK ADJUSTERS - TRUCK & BUS - LEYLAND

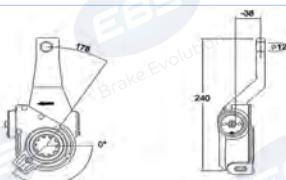
EBS Part No.	Application	Fitment Position (Chart - P25.4)	Spline Teeth No	Alternative	Opposite Hand	Image	
EBS2355	LEYLAND BUS OE: 10901199	1 Right	10	4W2355	EBS2390		
				KB2355			
				70583C			
EBS2365	LEYLAND BUS OE: 10907246	1 Right	10	4W2365	EBS2655		
				KB2365			
				70512			
EBS2390	LEYLAND BUS OE: 10901200	2 Left	10	4W2390	EBS2355		
				KB2390			
				70582C			
EBS2475	LEYLAND BUS OE: ACU3627	2 Left	10	4W2475	EBS2480		
				70943C			
EBS2480	LEYLAND BUS OE: ACU3628	1 Right	10	4W2480	EBS2475		
				70944C			
EBS2655	LEYLAND BUS OE: 10907245	2 Left	10	4W2655	EBS2365		
				KB2655			
				70511			











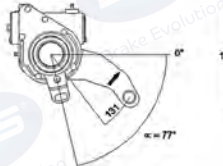

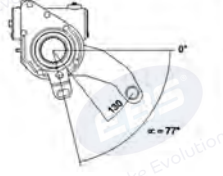

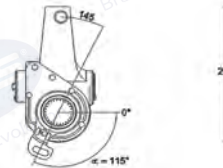

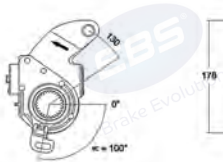
SLACK ADJUSTERS

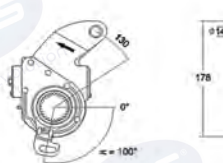

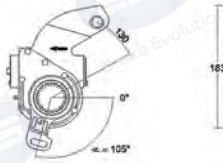
EBS AUTOMATIC SLACK ADJUSTERS - TRUCK & BUS - MAN

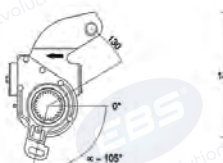
EBS Part No.	Application	Fitment Position (Chart - P25.4)	Spline Teeth No	Alternative	Opposite Hand	Image		
EBS2070	MAN TRUCK OE: 81506106211	2 Left	26	4W2070	EBS2075			
				KB2070				
				79208				
EBS2075	MAN TRUCK OE: 81506106210	1 Right	26	4W2075	EBS2070			
				KB2075				
				79209				
EBS2080	MAN TRUCK & BUS OE: 81506106231	1 & 2 Right & Left	26	4W2080	N/A			
				KB2080				
				79212				
EBS2090	MAN TRUCK OE: 81506106212	1 Right	26	4W2090	EBS2095			
				KB2090				
				79211				
EBS2095	MAN TRUCK OE: 81506106213	2 Left	26	4W2095	EBS2090			
				KB2095				
				79210				
EBS2610	MAN TRUCK OE: 81506106214	2 Left	26	4W2610	EBS2615			
				KB2610				
				79205				
EBS2615	MAN TRUCK OE: 81506106215	1 Right	26	4W2615	EBS2610			
				KB2615				
				79206				
EBS2620	MAN TRUCK & BUS OE: 81506106220	1 Right	26	4W2620	EBS2625			
				KB2620				
				79223				
EBS2625	MAN TRUCK & BUS OE: 81506106221	2 Left	26	4W2625	EBS2620			
				KB2625				
				79224				

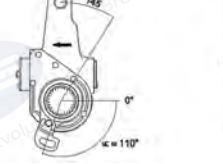
EBS AUTOMATIC SLACK ADJUSTERS - TRUCK & BUS - MAN

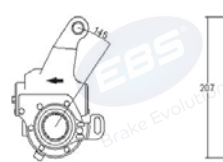
EBS Part No.	Application	Fitment Position (Chart - P25.4)	Spline Teeth No	Alternative	Opposite Hand	Image	
EBS3115	MAN BUS OE: 81506106222	2 Left	26	4W3115	EBS3120		
				KB3115			
				79225			
EBS3120	MAN BUS OE: 81506106223	1 Right	26	4W3120	EBS3115		
				KB3120			
				79226			
EBS3165	MAN TRUCK OE: 81506106216	1 & 2 Right & Left	26	4W3165	N/A		
				KB3165			
				79227			
EBS3265	MAN BUS OE: 81506106206	2 Left	26	4W3265	EBS3270		
				KB3265			
				79216C			
EBS3270	MAN BUS OE: 81506106205	1 Right	26	4W3270	EBS3265		
				KB3270			
				72979			
EBS3335	MAN BUS OE: 81506106203	2 Left	26	4W3335	EBS3340		
				KB3335			
				79220			
EBS3340	MAN BUS OE: 81506106204	1 Right	26	4W3340	EBS3335		
				KB3340			
				79219			
EBS3400	MAN TRUCK & BUS OE: 81506106217	1 & 2 Right & Left	26	4W3400	N/A		
				KB3400			
				79207C 72967			
25.80.0086	MAN TGA OE: 81506106266 Self-setting Automatic Slack Adjuster	--- ---	26	6Y6625	---		
				KB6625			
				80183			

SLACK ADJUSTERS

EBS AUTOMATIC SLACK ADJUSTERS - TRUCK & BUS - MAN

EBS Part No.	Application	Fitment Position (Chart - P23.4)	Spline Teeth No	Alternative	Opposite Hand	Image	
25.80.0176	MAN TGA	Left	26	6Y6620	25.80.0177		
	OE: 81506106263			KB6620			
	Self-setting Automatic Slack Adjuster			80176			
25.80.0177	MAN	Right	26	6Y6720	25.80.0176		
	OE: 81506106256			---			
	Self-setting Automatic Slack Adjuster			80177			
25.80.0178	MAN	Left	26	6Y6725	25.80.0179		
	OE: 81506106259			---			
	Self-setting Automatic Slack Adjuster			80178			
25.80.0179	MAN	Right	26	6Y6730	25.80.0178		
	OE: 81506106260			---			
	Self-setting Automatic Slack Adjuster			80179			
25.80.0180	MAN TGA	Left	26	6Y6630	25.80.0181		
	OE: 81506106261			KB6630			
	Self-setting Automatic Slack Adjuster			80180			
25.80.0181	MAN TGA	Right	26	6Y6660	25.80.0180		
	OE: 81506106262			KB6660			
	Self-setting Automatic Slack Adjuster			80181			

EBS AUTOMATIC SLACK ADJUSTERS - TRUCK & BUS - MCW

EBS Part No.	Application	Fitment Position (Chart - P23.4)	Spline Teeth No	Alternative	Opposite Hand	Image	
EBS2310	MCW BUS	Left	10	4W2310	EBS2700		
	OE: 8226963			KB2310			
				70893			
EBS2700	MCW BUS	Right	10	4W2700	EBS2310		
	OE: 8226964			KB2700			
				70894			
EBS3170	MCW BUS	Left	10	4W3170	---		
	OE: 2210966			KB3170			
				70931			

EBS AUTOMATIC SLACK ADJUSTERS - TRUCK & BUS - MERCEDES





EBS Part No.	Application	Fitment Position (Chart - P25.4)	Spline Teeth No	Alternative	Opposite Hand	Image	
EBS2040	MERCEDES BUS OE: 3574200538	1 & 2 Right & Left	26	4W2040	N/A		
				KB2040			
				72059			
EBS2045	MERCEDES TRUCK & BUS OE: 6174200238	1 & 2 Right & Left	26	4W2045	N/A		
				KB2045			
				70954C			
EBS2050	MERCEDES TRUCK OE: 6524200138	1 Right	26	4W2050	EBS2055		
				KB2050			
				72594			
EBS2055	MERCEDES TRUCK OE: 6524200038	2 Left	26	4W2055	EBS2050		
				KB2055			
				72593			
EBS2060	MERCEDES TRUCK OE: 6174200438	1 Right	26	4W2060	EBS2065		
				KB2060			
				70953			
EBS2065	MERCEDES TRUCK OE: 6524200338	2 Left	26	4W2065	EBS2060		
				KB2065			
				70952			
EBS2100	MERCEDES BUS OE: 3074200338	1 & 2 Right & Left	26	4W2100	N/A		
				KB2100			
				70775C			
EBS2130	MERCEDES BUS OE: 3014201138	1 & 2 Right & Left	26	4W2130	N/A		
				KB2130			
				72213			
EBS2135	MERCEDES TRUCK OE: 3834200438	1 Right	26	4W2135	EBS2140		
				KB2135			
				72036			

SLACK ADJUSTERS

EBS AUTOMATIC SLACK ADJUSTERS - TRUCK & BUS - MERCEDES

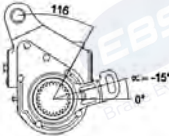
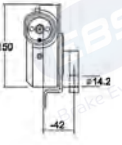
EBS Part No.	Application	Fitment Position (Chart - P.25.4)	Spline Teeth No	Alternative	Opposite Hand	Image	
EBS2140	MERCEDES TRUCK OE: 3834200538	2	26	4W2140	EBS2135		
				KB2140			
		Left		72037			
EBS2150	MERCEDES TRUCK OE: 3894200738	1 & 2	26	4W2150	N/A		
		Right & Left		KB2150			
				70867C			
EBS2155	MERCEDES TRUCK OE: 3874200138	1	26	4W2155	EBS2160		
				KB2155			
		Right		72174			
EBS2160	MERCEDES TRUCK OE: 3874200038	2	26	4W2160	EBS2155		
				KB2160			
		Left		72173			
EBS2420	MERCEDES TRUCK & BUS OE: 6524200238	1 & 2	26	4W2420	N/A		
		Right & Left		KB2420			
				72596			
EBS2440	MERCEDES BUS OE: 3054202638	1 & 2	26	4W2440	N/A		
		Right & Left		KB2440			
				70706C			
EBS2715	MERCEDES BUS OE: 3574201138	2	26	72211C	EBS2720		
		Left		KB2715			
EBS2720	MERCEDES BUS OE: 3574201238	1	26	72212C	EBS2715		
		Right		KB2720			
EBS2750	MERCEDES TRUCK OE: 6234200738	1	26	4W2750	EBS2755		
				KB2750			
		Right		72038			

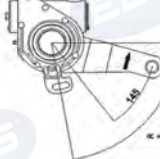
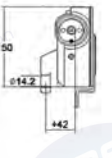
EBS AUTOMATIC SLACK ADJUSTERS - TRUCK & BUS - MERCEDES

EBS Part No.	Application	Fitment Position (Chart - P25.4)	Spline Teeth No	Alternative	Opposite Hand	Image		
EBS2755	MERCEDES TRUCK OE: 6234200638		26	4W2755	EBS2750			
				KB2755				
				72039				
EBS2930	MERCEDES BUS OE: 3574201338		26	4W2930	EBS3155			
				KB2930				
				72809				
EBS3125	MERCEDES BUS OE: 3074200138	2	26	4W3125	EBS3130			
		Left						
EBS3130	MERCEDES BUS OE: 3074200238	1	26	4W3130	EBS3125			
		Right						
EBS3145	MERCEDES TRUCK OE: 3854201738	2	26	4W3145	EBS3150			
				Left				
EBS3150	MERCEDES TRUCK OE: 3854201838	1	26	4W3150	EBS3145			
		Right						
EBS3155	MERCEDES BUS OE: 3574201438	1	26	4W3155	EBS2930			
				Right				
EBS3480	MERCEDES BUS OE: 3454201238	1 & 2	26	4W3480	N/A			
		Right & Left						
EBS3795	MERCEDES TRUCK OE: 6234200038	2	26	4W3795	EBS3800			
		Left						

SLACK ADJUSTERS

EBS AUTOMATIC SLACK ADJUSTERS - TRUCK & BUS - MERCEDES

EBS Part No.	Application	Fitment Position (Chart - P25-4)	Spline Teeth No	Alternative	Opposite Hand	Image	
EBS3800	MERCEDES TRUCK OE: 6234200138	1 Right	26	4W3800	EBS3795		
				KB3800			
				72055			
EBS3815	MERCEDES BUS OE: 3574201538	2 Left	26	4W3815	EBS3820		
				KB3815			
				72811			
EBS3820	MERCEDES BUS OE: 3574201638	1 Right	26	4W3820	EBS3815		
				KB3820			
				72812			
EBS4010	MERCEDES BUS OE: 3574200638	1 Right	26	4W4010	EBS4015		
				KB4010			
				72060			
EBS4015	MERCEDES BUS OE: 3574200738	2 Left	26	4W4015	EBS4010		
				KB4015			
				72061			
EBS4170	MERCEDES TRUCK OE: 3934200038	1 & 2 Right & Left	26	4W4170	N/A		
				KB7140			
				70870			
EBS4415	MERCEDES: 0003520840	Left	19	4W4415	EBS4420		
				79637C			
EBS4420	MERCEDES: 0003520940	Right	19	79638C	EBS4415		
				4W4420			
EBS4500	MERCEDES TRUCK OE: 3844207438	2 Left	26	---	N/A		

				79186			

EBS AUTOMATIC SLACK ADJUSTERS - TRUCK & BUS - MERCEDES

EBS Part No.	Application	Fitment Position (Chart - P23.4)	Spline Teeth No	Alternative	Opposite Hand	Image		
25.80.0000	MERCEDES ACTROS OE: 9454200238 Self-setting Automatic Slack Adjuster	Left	26	6Y6500	25.80.0001			
				KB6500				
				80000C				
25.80.0001	MERCEDES ACTROS OE: 9454200338 Self-setting Automatic Slack Adjuster	Right	26	6Y6505	25.80.0000			
				KB6505				
				80001C				
25.80.0008	MERCEDES ACTROS OE: 9454200038 Self-setting Automatic Slack Adjuster	Left	26	6Y6510	25.80.0009			
				KB6510				
				80008C				
25.80.0009	MERCEDES ACTROS OE: 9454200138 Self-setting Automatic Slack Adjuster	Right	26	6Y6515	25.80.0008			
				KB6515				
				80009C				
25.80.0010	MERCEDES ACTROS OE: 9454200838 Self-setting Automatic Slack Adjuster	Left	26	6Y6520	25.80.0011			
				KB6520				
				80010C				
25.80.0011	MERCEDES ACTROS OE: 9454200738 Self-setting Automatic Slack Adjuster	Right	26	6Y6525	25.80.0010			
				KB6525				
				80011C				
25.80.0014	MERCEDES ACTROS OE: 9454200438 Self-setting Automatic Slack Adjuster	Left	26	6Y6540	25.80.0030			
				KB6540				
				80014C				
25.80.0030	MERCEDES ACTROS OE: 9454200938 Self-setting Automatic Slack Adjuster	Right	26	6Y6545	25.80.0014			
				KB6545				
				80030C				

SLACK ADJUSTERS

EBS AUTOMATIC SLACK ADJUSTERS - TRUCK & BUS - NEOPLAN

EBS Part No.	Application	Fitment Position (Chart - P25.4)	Spline Teeth No	Alternative	Opposite Hand	Image	
EBS2505	NEOPLAN BUS OE: B510643	Left	19	4W2505	EBS2510		
				KB2505			
				72203			
EBS2510	NEOPLAN BUS OE: B510642	Right	19	4W2510	EBS2505		
				KB2510			
				72204			

EBS AUTOMATIC SLACK ADJUSTERS - TRUCK & BUS - OPTARE











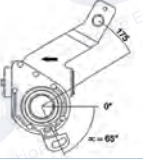

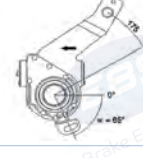

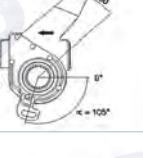

EBS Part No.	Application	Fitment Position (Chart - P25.4)	Spline Teeth No	Alternative	Opposite Hand	Image	
EBS2955	OPTARE BUS OE: L2220055	Right & Left	28	4W2955	N/A		
				KB2955			
				79177			

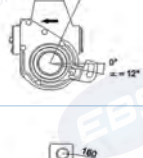

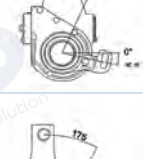
EBS AUTOMATIC SLACK ADJUSTERS - TRUCK & BUS - RABA

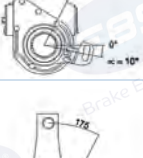
EBS Part No.	Application	Fitment Position (Chart - P25.4)	Spline Teeth No	Alternative	Opposite Hand	Image	
EBS3950	RABA	---	20	72928C	N/A		

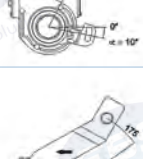
EBS AUTOMATIC SLACK ADJUSTERS - TRUCK & BUS - RENAULT











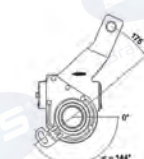

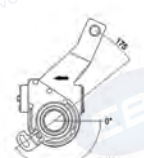

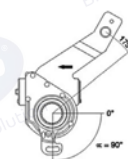

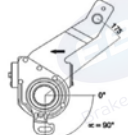
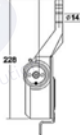

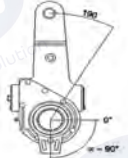
EBS Part No.	Application	Fitment Position (Chart - P25.4)	Spline Teeth No	Alternative	Opposite Hand	Image	
EBS2230	RENAULT TRUCK OE: 5010056686	2	27	4W2230	EBS2240		
				KB2230			
		Left		79014			
EBS2240	RENAULT TRUCK OE: 5010056685	1	27	4W2240	EBS2230		
				KB2240			
		Right		79013			
EBS2630	RENAULT TRUCK OE: 5010098862	2	27	4W2630	EBS2635		
				KB2630			
		Left		79296			
EBS2635	RENAULT TRUCK OE: 5010098863	1	27	4W2635	EBS2630		
				KB2635			
		Right		79297			
EBS2640	RENAULT TRUCK OE: 5010216843	2	27	4W2640	EBS2645		
				KB2640			
		Left		79229C			
EBS2645	RENAULT TRUCK OE: 5010216844	1	27	4W2645	EBS2640		
				KB2645			
		Right		79300			
EBS2795	RENAULT TRUCK OE: 5000791212	2	27	4W2795	EBS2800		
				KB2795			
		Left		79017			
EBS2800	RENAULT TRUCK OE: 5000791213	1	27	4W2800	EBS2795		
				KB2800			
		Right		79018			
EBS2815	RENAULT TRUCK & BUS OE: 500078264	1	27	4W2815	EBS2820		
				KB2815			
		Right		79007			

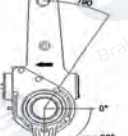
SLACK ADJUSTERS

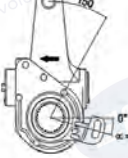
EBS AUTOMATIC SLACK ADJUSTERS - TRUCK & BUS - RENAULT

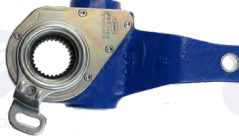
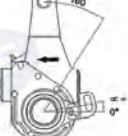
EBS Part No.	Application	Fitment Position (Chart - P25.4)	Spline Teeth No	Alternative	Opposite Hand	Image		
EBS2820	RENAULT TRUCK & BUS OE: 5000787265	2	27	4W2820	EBS2815			
				KB2820				
		Left		79008				
EBS2905	RENAULT TRUCK OE: 5010098831	1	28	4W2905	EBS2910			
				KB2905				
		Right		79288				
EBS2910	RENAULT TRUCK OE: 5010098832	2	28	4W2910	EBS2905			
				KB2910				
		Left		79289				
EBS2920	RENAULT TRUCK OE: 5010098860	1	27	4W2920	EBS2925			
				KB2920				
		Right		79294				
EBS2925	RENAULT TRUCK OE: 5010098861	2	27	4W2925	EBS2920			
				KB2925				
		Left		79295				
EBS2940	RENAULT TRUCK OE: 5010216904	1	27	4W2940	EBS2945			
				KB2940				
		Right		79301				
EBS2945	RENAULT TRUCK OE: 5010216905	2	27	4W2945	EBS2940			
				KB2945				
		Left		79302				
EBS3040	RENAULT TRUCK OE: 5010260117	1	27	4W3040	EBS3045			
				KB3040				
		Right		79310				
EBS3045	RENAULT TRUCK OE: 5010260118	2	27	4W3045	EBS3040			
				KB3045				
		Left		79311				

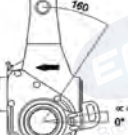
EBS AUTOMATIC SLACK ADJUSTERS - TRUCK & BUS - RENAULT











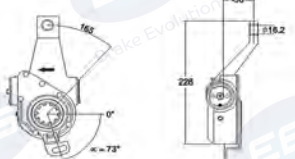

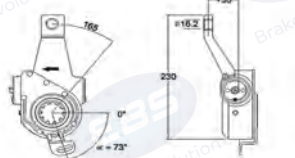
EBS Part No.	Application	Fitment Position (Chart - P25.4)	Spline Teeth No	Alternative	Opposite Hand	Image		
EBS3050	RENAULT TRUCK OE: 5010260116	1 Right	27	4W3050	EBS3055			
				KB3050				
				79309				
EBS3055	RENAULT TRUCK OE: 5010260115	2 Left	27	4W3055	EBS3050			
				KB3055				
				79308				
EBS3085	RENAULT BUS OE: 5010013393	1 Right	27	79020C	EBS3090			
EBS3090	RENAULT BUS OE: 5010013394	2 Left	27	79021C	EBS3085			
EBS3195	RENAULT TRUCK & BUS OE: 5000785205	2 Left	27	4W3195	EBS3200			
				KB3195				
				79150				
EBS3200	RENAULT TRUCK & BUS OE: 5000785206	1 Right	27	4W3200	EBS3195			
				KB3200				
				79151				
EBS3205	RENAULT TRUCK OE: 5000445830	1 & 2 Right & Left	27	4W3205	N/A			
				KB3205				
				79011				
EBS3485	RENAULT TRUCK OE: 5010260027	2 Left	28	4W3485	EBS3490			
				KB3485				
				79304				
EBS3490	RENAULT TRUCK OE: 5010260028	1 Right	28	4W3490	EBS3485			
				KB3490				
				79305				

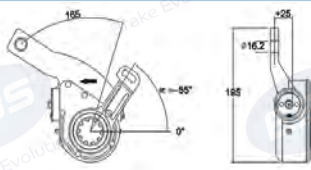
SLACK ADJUSTERS

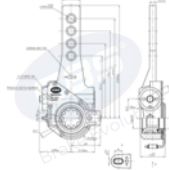
EBS AUTOMATIC SLACK ADJUSTERS - TRUCK & BUS - RENAULT

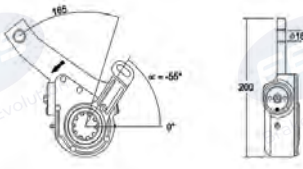
EBS Part No.	Application	Fitment Position (Chart - P25.4)	Spline Teeth No	Alternative	Opposite Hand	Image	
EBS3755	RENAULT TRUCK OE: 5010197578	---	27	4W3755	EBS4200		
				KB3755			
				79441			
EBS3825	RENAULT TRUCK OE: 5000788696	---	27	4W3825	EBS3830		
				KB3825			
		Right		79009			
EBS3830	RENAULT TRUCK OE: 5000788697	2	27	4W3830	EBS3825		
		Left		KB3830			
				79010			
EBS3840	RENAULT TRUCK OE: 5010260023	2	27	4W3840	EBS3845		
		Left		KB3840			
				79306			
EBS3845	RENAULT TRUCK OE: 5010260024	1	27	4W3845	EBS3840		
		Right		KB3845			
				79307			
EBS4200	RENAULT OE: 5010197577	---	27	4W4200	EBS3755		
		---		KB4200			
		---		79440			
EBS9683	RENAULT OE: 5430060289	---	27	4W4460	EBS9684		
		---		KB4460			
		---		79683C			
EBS9684	RENAULT OE: 5430060288	---	27	4W4465	EBS9683		
		---		KB4465			
		---		79684C			

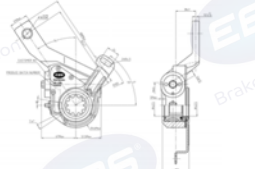
EBS AUTOMATIC SLACK ADJUSTERS - TRUCK & BUS - SCANIA

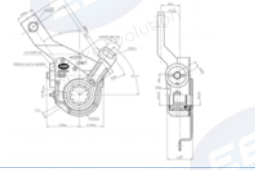
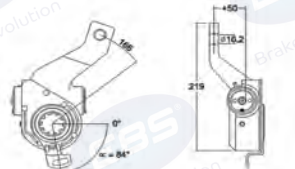





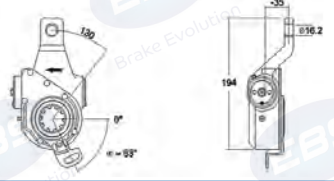

EBS Part No.	Application	Fitment Position (Chart - P25.4)	Spline Teeth No	Alternative	Opposite Hand	Image	
EBS2210	SCANIA TRUCK & BUS OE: 1112830	1 Right	10	4W2210	EBS2215		
				KB2210			
				72264			
EBS2215	SCANIA TRUCK & BUS OE: 1112829	2 Left	10	4W2215	EBS2210		
				KB2215			
				72263			
EBS2220	SCANIA TRUCK & BUS OE: 1112833	2 Left	10	4W2220	EBS2260		
				KB2220			
				72660			
EBS2249	SCANIA OE: 633107720	1 & 2 Right & Left	10	72249	N/A		
EBS2250	SCANIA TRUCK & BUS OE: 1112831	1 & 2 Right & Left	10	4W2250	N/A		
				KB2250			
				72662C			
EBS2260	SCANIA TRUCK & BUS OE: 1112834	1 Right	10	4W2260	EBS2220		
				KB2260			
				72661			
EBS2265	SCANIA TRUCK & BUS OE:	1 Right	10	4W2265	EBS2270		
				KB2265			
				72745C			
EBS2270	SCANIA TRUCK & BUS OE:	2 Left	10	4W2270	EBS2265		
				KB2270			
				72744C			
EBS2360	SCANIA BUS OE: 1112839	2 Left	10	4W2360	EBS2595		
				KB2360			
				72825			

SLACK ADJUSTERS

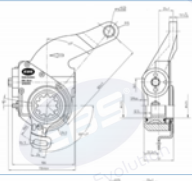
EBS AUTOMATIC SLACK ADJUSTERS - TRUCK & BUS - SCANIA

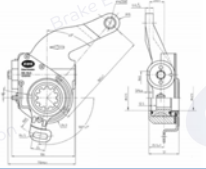
EBS Part No.	Application	Fitment Position (Chart - P25.4)	Spline Teeth No	Alternative	Opposite Hand	Image		
EBS2585	SCANIA TRUCK & BUS OE: 394189	1 Right	10	4W2585	EBS2590			
				KB2585				
				72727				
EBS2590	SCANIA TRUCK & BUS OE: 394190	2 Left	10	4W2590	EBS2585			
				KB2590				
				72728				
EBS2595	SCANIA BUS OE:1112840	1 Right	10	4W2595	EBS2360			
				KB2595				
				72826				
EBS2710	SCANIA TRUCK & BUS OE: 1112841	1 & 2 Right & Left	10	4W2710	N/A			
				KB2710				
				72654				
EBS2735	SCANIA TRUCK & BUS OE: 1358634	1 Right	10	4W2735	EBS2740			
				KB2735				
				79033 79442C				
EBS2740	SCANIA TRUCK & BUS OE: 1358635	2 Left	10	4W2740	EBS2735			
				KB2740				
				79034 79443C				
EBS3315	SCANIA BUS EO: 321469	2 Left	10	4W3315	EBS3320			
				KB3315				
				72955C				
EBS3320	SCANIA BUS OE: 321470	1 Right	10	4W3320	EBS3315			
				KB3320				
				72954				
EBS3520	SCANIA TRUCK OE: 394195	1 Right	10	4W3520	EBS3525			
				KB3520				
				72729				

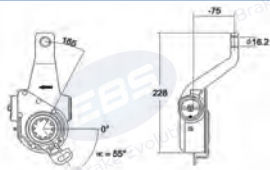
EBS AUTOMATIC SLACK ADJUSTERS - TRUCK & BUS - SCANIA

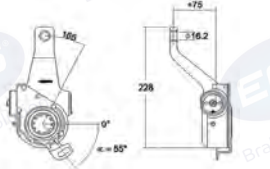
EBS Part No.	Application	Fitment Position (Chart - P25.4)	Spline Teeth No	Alternative	Opposite Hand	Image	
EBS3525	SCANIA TRUCK OE: 394196	2	10	4W3525	EBS3520		
		Left		KB3525			
		72730					
EBS3540	SCANIA OE: 5021173921	1 & 2	10	79348C	EBS3545		
		Right & Left					
EBS3545	SCANIA	1 & 2	10	79347C	EBS3540		
		Right & Left					
EBS3550	DAF TRUCK OE: 219860	2	10	4W3550	EBS3555		
		Left		KB3550			
				79105			
EBS3555	DAF TRUCK OE: 219859	1	10	4W3555	EBS3550		
		Right		KB3555			
				79106			

EBS AUTOMATIC SLACK ADJUSTERS - TRUCK & BUS - SISU

EBS Part No.	Application	Fitment Position (Chart - P25.4)	Spline Teeth No	Alternative	Opposite Hand	Image	
EBS3965	SISU TRUCK & BUS OE:	---	26	79396C	EBS3970	 	
EBS3970	SISU TRUCK & BUS OE:	---	26	79397C	EBS3965	 	
EBS4315	SISU TRUCK & BUS OE:	---	26	4W4315	EBS4320		
		---		KB4315			
		---		79407C			
EBS4320	SISU TRUCK & BUS OE:	---	26	4W4320	EBS4315		
		---		KB4320			
		---		79408C			

SLACK ADJUSTERS

EBS AUTOMATIC SLACK ADJUSTERS - TRUCK & BUS - VAN HOOL

EBS Part No.	Application	Fitment Position (Chart - P25.4)	Spline Teeth No	Alternative	Opposite Hand	Image		
EBS2775	VAN HOOL BUS OE: 633104610	2 Left	19	4W2775	EBS2780			
				KB2775				
				72459				
EBS2780	VAN HOOL BUS OE: 633104620	1 Right	19	4W2780	EBS2775			
				KB2780				
				72460				
EBS3030	VAN HOOL BUS OE: 633104690	1 Right	19	4W3030	EBS3035			
				KB3030				
				72462				
EBS3035	VAN HOOL BUS OE: 633104700	2 Left	19	4W3035	EBS3030			
				KB3035				
				72461				

EBS AUTOMATIC SLACK ADJUSTERS - TRUCK & BUS - VOLVO

EBS Part No.	Application	Fitment Position (Chart - P25.4)	Spline Teeth No	Alternative	Opposite Hand	Image		
EBS2275	VOLVO BUS OE: 1196321	1 & 2 Right & Left	10	4W2275	N/A			
				KB2275				
				72678				
EBS2280	VOLVO BUS OE: 1195461	2 Left	10	4W2280	EBS2300			
				KB2280				
				72782				
EBS2285	VOLVO BUS OE: 1136432	2 Left	10	4W2285	EBS2290			
				KB2285				
				72723				
EBS2290	VOLVO BUS OE: 1196433	1 Right	10	4W2290	EBS2285			
				KB2290				
				72724				
EBS2295	VOLVO BUS OE: 1196322	1 & 2 Right & Left	10	4W2295	N/A			
				KB2295				
				72726				

EBS AUTOMATIC SLACK ADJUSTERS - TRUCK & BUS - VOLVO

EBS Part No.	Application	Fitment Position (Chart - P25.4)	Spline Teeth No	Alternative	Opposite Hand	Image		
EBS2300	VOLVO BUS OE: 1195462	1 Right	10	4W2300	EBS2280			
				KB2300				
				72783				
EBS2540	VOLVO TRUCK OE: 1586192	1 Right	10	4W2540	EBS2545			
				KB2540				
				72670				
EBS2545	VOLVO TRUCK OE: 1586193	2 Left	10	4W2545	EBS2540			
				KB2545				
				72671				
EBS2575	VOLVO BUS OE: 1134293	2 Left	10	4W2575	EBS2580			
				KB2575				
				72717				
EBS2580	VOLVO BUS OE: 1134294	1 Right	10	4W2580	EBS2575			
				KB2580				
				72718				
EBS3135	VOLVO BUS OE: 1197966	2 Left	10	4W3135	EBS3140			
				KB3135				
				72785				
EBS3140	VOLVO BUS OE: 1197965	1 Right	10	4W3140	EBS3135			
				KB3140				
				72784				
EBS3210	VOLVO BUS OE: 1134452	1 Right	10	4W3210	N/A			
				KB3210				
				72720C				
EBS3710	VOLVO TRUCK OE: 1592875	1 & 2 Right & Left	10	4W3710	N/A			
				KB3710				
				72725				
EBS3805	VOLVO BUS OE: 1134829	2 Left	10	4W3805	EBS3810			
				KB3805				
				72721				

SLACK ADJUSTERS

EBS AUTOMATIC SLACK ADJUSTERS - TRUCK & BUS - VOLVO

EBS Part No.	Application	Fitment Position (Chart - P25.4)	Spline Teeth No	Alternative	Opposite Hand	Image	
EBS3810	VOLVO BUS OE: 1134830	1 Right	10	4W3810	EBS3805		
				KB3810			
				72722			
EBS3910	VOLVO BUS OE: 3193400	2 Left	10	4W3910	EBS3915		
				KB3910			
				79677			
EBS3915	VOLVO BUS OE: 3193401	1 Right	10	4W3915	EBS3910		
				KB3915			
				79678			
EBS4255	VOLVO BUS	1 Right	10	---	EBS4260		

				79641C			
EBS4260	VOLVO BUS	2 Left	10	---	EBS4255		

				79642C			

EBS AUTOMATIC SLACK ADJUSTERS - TRUCK & BUS - ZF AXLES

EBS Part No.	Application	Fitment Position (Chart - P25.4)	Spline Teeth No	Alternative	Opposite Hand	Image	
EBS2785	LIAZ BUS OE: 070276010	---	19	4W2785	EBS2790		
				KB2785			
				72688			
EBS2790	LIAZ BUS OE: 070276011	---	19	4W2790	EBS2785		
				KB2790			
				72689			
EBS3295	ZF AXLE OE: 0501207555	1 & 2 Right & Left	19	4W3295	N/A		
				KB3295			
				72641			

TRAILER FITMENT POSITION GUIDE

Where possible EBS has detailed to which side of the vehicle the EBS slack adjuster reference is fitted.

The information we have provided within this section should only be used as a guide.

The guaranteed way of selecting the correct replacement EBS product is to identify the actual reference of the item that is being removed from the vehicle itself.

Please note - as the information is not always available this is only an indication of the applications suited for each EBS reference.

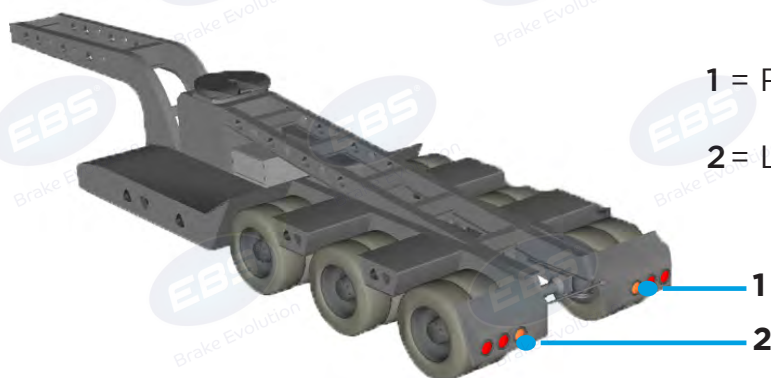

1 = Right Hand Side Of Vehicle Fitment

2 = Left Hand Side Of Vehicle Fitment

EBS AUTOMATIC SLACK ADJUSTERS - TRAILER - BPW						
EBS Part No.	Application	Fitment Position (Chart - P25.4)	Spline Teeth No	Alternative	Opposite Hand	Image
EBS1005	BPW AXLE FAST FIT OE: 0517482212	1 & 2	10	4W1005	N/A	
		Right & Left		KB1005		
				72875		
EBS1010	BPW AXLE FAST FIT OE: 0517482242	1 & 2	10	4W1010	N/A	
		Right & Left		KB1010		
				72876		
EBS1125	BPW AXLE FAST FIT OE:	1 & 2	10	4W1125	N/A	
		Right & Left		KB1125		
				72053C		
25.80.0019	BPW AXLE FAST FIT OE: 0557482873 Self-setting Automatic Slack Adjuster	1 & 2	10	4W1046	N/A	
		Right & Left		KB1046		
				80019		

EBS AUTOMATIC SLACK ADJUSTERS - TRAILER - FRUEHAUF

EBS Part No.	Application	Fitment Position (Chart - P25.4)	Spline Teeth No	Alternative	Opposite Hand	Image
EBS1020	FRUEHAUF AXLE FAST FIT OE: AJB0743001	1 & 2	37	4W1020	N/A	
		Right & Left		KB1020		
				79022		
25.80.0021	FRUEHAUF AXLE FAST FIT OE: AJB0743001 Self-setting Automatic Slack Adjuster	1 & 2	37	6Y1510	N/A	
		Right & Left		KB1510		
				80021D		

EBS SLACK ADJUSTERS - GIGANT

EBS Part No.	Application	Fitment Position (Chart - P25.4)	Spline Teeth No	Alternative	Opposite Hand	Image
25.80.0108	GIGANT OE: 09319434	1 & 2	10	6Y1550	N/A	
		Right & Left		80108		
EBS1270	GIGANT OE: 09319456	1 & 2	10	4W1270	N/A	
		Right & Left		79149		
EBS1320	GIGANT	1 & 2	10	79138C	EBS1325	
		Right & Left				
EBS1325	GIGANT	1 & 2	10	79139C	EBS1320	
		Right & Left				
25.80.0134	GIGANT OE: 09319440	1 & 2	10	6Y1580	N/A	
		Right & Left		80134C		

EBS AUTOMATIC SLACK ADJUSTERS - TRAILER - MERITOR (ROR)

EBS Part No.	Application	Fitment Position (Chart - P25.4)	Spline Teeth No	Alternative	Opposite Hand	Image
EBS1000 <small>See Also EBS2788</small>	MERITOR AXLE FAST FIT OE: 21223694 "Knuckle" Style Lever	1 & 2	10	4W1000	N/A	 Control arm brackets also available separately. EBS Refs ZJ117 & ZJ118 - See Page 25.40 
		Right & Left		KB1000		
		72788				
EBS1025	MERITOR	1 & 2	10	4W1025	N/A	 
		Right & Left		KB1025		
		79004				
EBS1055	MERITOR OE: 21217569	1 & 2	10	4W1055	N/A	 
		Right & Left		KB1055		
		72261				
EBS1065	MERITOR	1 & 2	10	4W1065	N/A	 
		Right & Left		KB1065		
		72256				
EBS1085	MERITOR STEER AXLE OE: 21229280	2	10	4W1085	EBS1090	 
		Left		KB1090		
				79097		
EBS1090	MERITOR STEER AXLE OE: 21229281	1	10	4W1090	EBS1085	 
		Right		KB1085		
				79098		
EBS1170	MERITOR OE: 21229290	1 & 2	10	79183C	N/A	 
		Right & Left		KB1170		
		2122929				
EBS1180	MERITOR	1 & 2	10	79160	N/A	 
		Right & Left				
EBS1315	MERITOR	1 & 2	28	4W1315	N/A	 
		Right & Left		KB1315		
				79504C		

SLACK ADJUSTERS

EBS AUTOMATIC SLACK ADJUSTERS - TRAILER - SAE

EBS Part No.	Application	Fitment Position (Chart - P25.4)	Spline Teeth No	Alternative	Opposite Hand	Image	
25.80.0124	SAE	---	10	80124C	25.80.0125		
	OE: 09319437	---		6Y1560			
	---	09319437					
25.80.0125	SAE	---	10	80125C	25.80.0124		
	OE: 09319438	---		6Y1565			
	---	09319438					
EBS2788 <small>See Also EBS1000</small>	MERITOR AXLE FAST FIT OE: 21223694 "U" Style Lever	1 & 2	10	4W1000	N/A	 <small>Control arm brackets also available separately. EBS Refs ZJ117 & ZJ118 - See Page 25-40</small>	
		Right & Left		KB1000			
				72788			
25.80.0020	MERITOR OE: 21229249 Self-setting Automatic Slack Adjuster	1 & 2	10	6Y1505	N/A		
		Right & Left		KB1505			
				80020			
EBS1030	SAF AXLE FAST FIT OE: 4175024900	1 & 2	10	4W1030	N/A		
		Right & Left		KB1030			
				79005			
EBS1035	SAF AXLE FAST FIT OE: 4175024000	1 & 2	10	4W1035	N/A		
		Right & Left		KB1035			
				72948			
EBS1040	SAF AXLE FAST FIT OE: 4175024800	1 & 2	10	4W1040	N/A		
		Right & Left		KB1040			
				79035			

EBS AUTOMATIC SLACK ADJUSTERS - TRAILER - SAF

EBS Part No.	Application	Fitment Position (Chart - P25.4)	Spline Teeth No	Alternative	Opposite Hand	Image	
EBS1075	SAF	1 & 2	10	4W1075	N/A		
		Right & Left		KB1075			
				72250C			
EBS1080	SAF AXLE FAST FIT OE: 4175014100	1 & 2	10	4W1080	N/A		
		Right & Left		KB1080			
				70949C			
EBS1110	SAF STEER AXLE PEG TYPE OE: 4175014000	1	10	4W1110	EBS1160		
		Right		KB1110			
				72239			
EBS1115	SAF PEG TYPE	1	10	4W1115	EBS1120		
		Right		KB1115			
EBS1120	SAF PEG TYPE	2	10	4W1120	EBS1115		
		Left		KB1120			
				70803			
EBS1130	SAF PEG TYPE	1	10	4W1130	EBS1135		
		Right		KB1130			
				72008			
EBS1135	SAF STEER AXLE PEG TYPE OE: 4175014900	2	10	4W1135	EBS1130		
		Left		KB1135			
				72007			
EBS1160	SAF STEER AXLE PEG TYPE OE: 4175013900	2	10	4W1160	EBS1110		
		Left		KB1160			
				72238			
EBS1330	SAF OE: 4175023500	1	10	4W1330	EBS1335		
		Right		KB1330			
				79043C			

SLACK ADJUSTERS

EBS AUTOMATIC SLACK ADJUSTERS - TRAILER - SAF

EBS Part No.	Application	Fitment Position (Chart - P25.4)	Spline Teeth No	Alternative	Opposite Hand	Image
EBS1335	SAF OE: 4175023600	2	10	4W1335	EBS1330	
		Left		KB1335		
				79044C		
EBS1605E	SAF OE: 4175037400	1 & 2	10	80295	N/A	
		Right & Left		4175037400		
EBS9792	SAF	1	10	---	EBS9793	
		Right		79792C		
EBS9793	SAF	2	10	---	EBS9792	
		Left		79793C		
25.80.0022 Supplied Singular See Also 25.80.0022D	SAF OE: 4175024900 Self-setting Automatic Slack Adjuster	1 & 2	10	6Y1515	N/A	
		Right & Left		80022S		
25.80.0022D Supplied As a Boxed Pair See Also 25.80.0022	SAF OE: 4175024900 Self-setting Automatic Slack Adjuster	1 & 2	10	6Y1515	N/A	
		Right & Left		KB1515		
				80022D		
25.80.0041	SAF OE: 4175026200 Self-setting Automatic Slack Adjuster	1 & 2	10	6Y1535	N/A	
		Right & Left		KB1535		
				80041		

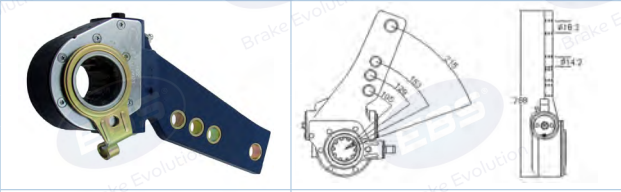
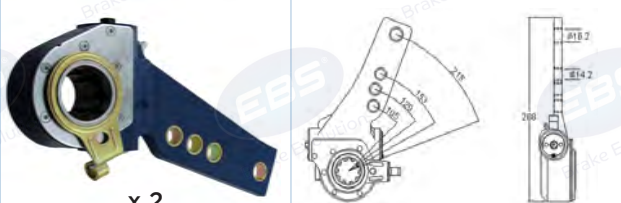
EBS AUTOMATIC SLACK ADJUSTERS - TRAILER - SMB						
EBS Part No.	Application	Fitment Position (Chart - P25.4)	Spline Teeth No	Alternative	Opposite Hand	Image
EBS1025	SMB AXLE FAST SIT OE: MO02416	1 & 2	10	4W1025	N/A	
		Right & Left		KB1025		
				79004		
25.80.0023 Supplied Singular See Also 25.80.0022	SMB AXLE FAST SIT OE: MO02416	1 & 2	10	6Y1520	N/A	
		Right & Left		KB1520		
				80023S		
25.80.0023D Supplied As a Boxed Pair See Also 25.80.0022	SMB AXLE FAST SIT OE: MO02416	1 & 2	10	6Y1520	N/A	
		Right & Left		KB1520		
				80023D		

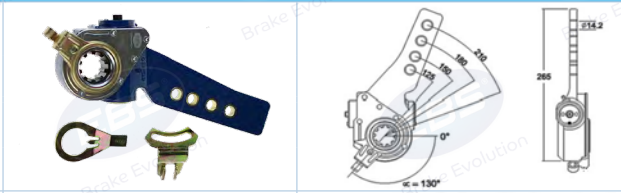
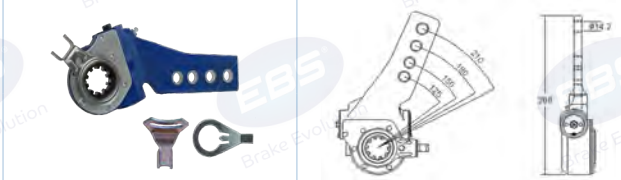

EBS SLACK ADJUSTERS - TRAILER						
EBS Part No.	Application	Fitment Position (Chart - P25.4)	Spline Teeth No	Alternative	Opposite Hand	Image
EBS1015	TRAILOR OE: 9002105	1 & 2	10	4W1015	N/A	
		Right & Left		72254C		
				79023D		
				79023S		
25.80.0024	TRAILOR OE: TO017649Z	1 & 2	10	6Y1525	N/A	
		Right & Left		KB1525		
				80024		

EBS SLACK ADJUSTERS - UNIVERSAL						
EBS Part No.	Application	Fitment Position (Chart - P25.4)	Spline Teeth No	Alternative	Opposite Hand	Image
EBS1137	UNIVERSAL	1 & 2	10	SBT21137	N/A	
		Right & Left				

SLACK ADJUSTERS

EBS MANUAL SLACK ADJUSTERS

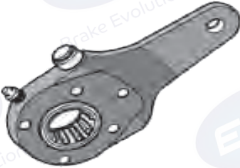
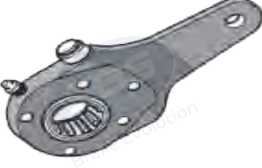
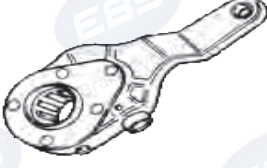
EBS Part No.	Information	Fitment Position (Chart - P25.4)	Spline Teeth No	Alternative	Opposite Hand	Image	Repair Kit
25.00.1005	BPW	1 & 2	10	100001721	N/A		---
		Straight		05.174.52.61.0			
25.00.1006	MERITOR	1 & 2	10	100101047	N/A		---
		Straight					
N264432	Manual Slack Adjuster	2	10	264432	N264433		---
		Left					
N264433	Manual Slack Adjuster	1	10	264433	N264432		---
		Right					
N267026	Manual Slack Adjuster	---	10	267026	N267027		---
	PL24 25mm Offset	---					
N267027	Manual Slack Adjuster	---	10	267027	N267026		---
	PL24 25mm Offset	---					
N267083	Manual Slack Adjuster	2	10	267083	N267084		---
	PL18 50mm Offset	Left					
N267084	Manual Slack Adjuster	1	10	267084	N267083		---
	PL18 50mm Offset	Right					
N274971	Manual Slack Adjuster	1 & 2	10	274971	N/A		---
	PL30 Straight	Right & Left					

EBS MANUAL SLACK ADJUSTERS							
EBS Part No.	Information	Fitment Position (Chart - P25.4)	Spline Teeth No	Alternative	Opposite Hand	Image	Repair Kit
N281966	Manual Slack Adjuster	1	10	281966	N281967		---
	PL20 38.1mm Offset	Right					
N281967	Manual Slack Adjuster	2	10	281967	N281966		---
	PL20 38.1mm Offset	Left					
---	Manual Slack Adjuster	1	10	295183	N295184		---
	PL24 22.2mm Offset	Right					
N295184	Manual Slack Adjuster	2	10	295184	N295183		---
	PL24 22.2mm Offset	Left					
N295567	Manual Slack Adjuster	---	10	295567	---		---

SLACK ADJUSTERS

EBS REPAIR KITS - Z CAM

<p>EKPP.4.1</p>		<p>EKPP.4.2</p>		<p>EKPP.4.3</p>		<p>EKPP.4.4</p>	
ALT. Part No.	272909 8550978 ST4014 3097099	ALT. Part No.	8550977 272908 ST4013 3091700	ALT. Part No.	6819150 1696924 ST1036 272906	ALT. Part No.	6819151 696925 ST1037 272907
APPLICATION	LEFT HAND	APPLICATION	RIGHT HAND	APPLICATION	LEFT HAND	APPLICATION	RIGHT HAND
<p>EKPP.4.5</p>		<p>EKPP.4.6</p>		<p>EKPP.4.7</p>		<p>EKPP.4.8</p>	
ALT. Part No.	3090954 68192410 1696448	ALT. Part No.	1696453 272910 SP8540 1696453	ALT. Part No.	272905	ALT. Part No.	ST1033
APPLICATION	---	APPLICATION	---	APPLICATION	---	APPLICATION	---
<p>EKPP.4.9</p>		<p>EKPP.4.10</p>		<p>EKPP.4.11</p>		<p>EKPP.4.12</p>	
ALT. Part No.	ST4011	ALT. Part No.	1696449	ALT. Part No.	3097092 1696444 5001868113 68192115 9C462296AA	ALT. Part No.	3097299 1698346
APPLICATION	---	APPLICATION	---	APPLICATION	---	APPLICATION	---
<p>EKPP.4.13</p>		<p>EKPP.4.14</p>					
ALT. Part No.	64225252 1696446	ALT. Part No.	ST1035				
APPLICATION	N/A	APPLICATION	N/A				

EBS SLACK ADJUSTER REPAIR KIT - CONTROL ARMS

ZJ117		ZJ118	
			
ALT. Part No.	---	ALT. Part No.	--
APPLICATION	FOR EBS1000 & EBS2788	APPLICATION	FOR EBS1000 & EBS2788

EBS SLACK ADJUSTER REPAIR KIT - HALDEX 7 SERIES

EBS Part No.	Alternative	Application	Image
EKGH.13S	76046 5001825536	HALDEX 7 SERIES AUTO SLACK ADJUSTERS	

EBS SLACK ADJUSTERS REPAIR KITS - HALDEX

EKWL.300	EKWL.301
	

WEAR SENSOR CONNECTING CABLE

30.11.10008	
	
ALT. Part No.	A0005404136

SLACK ADJUSTERS

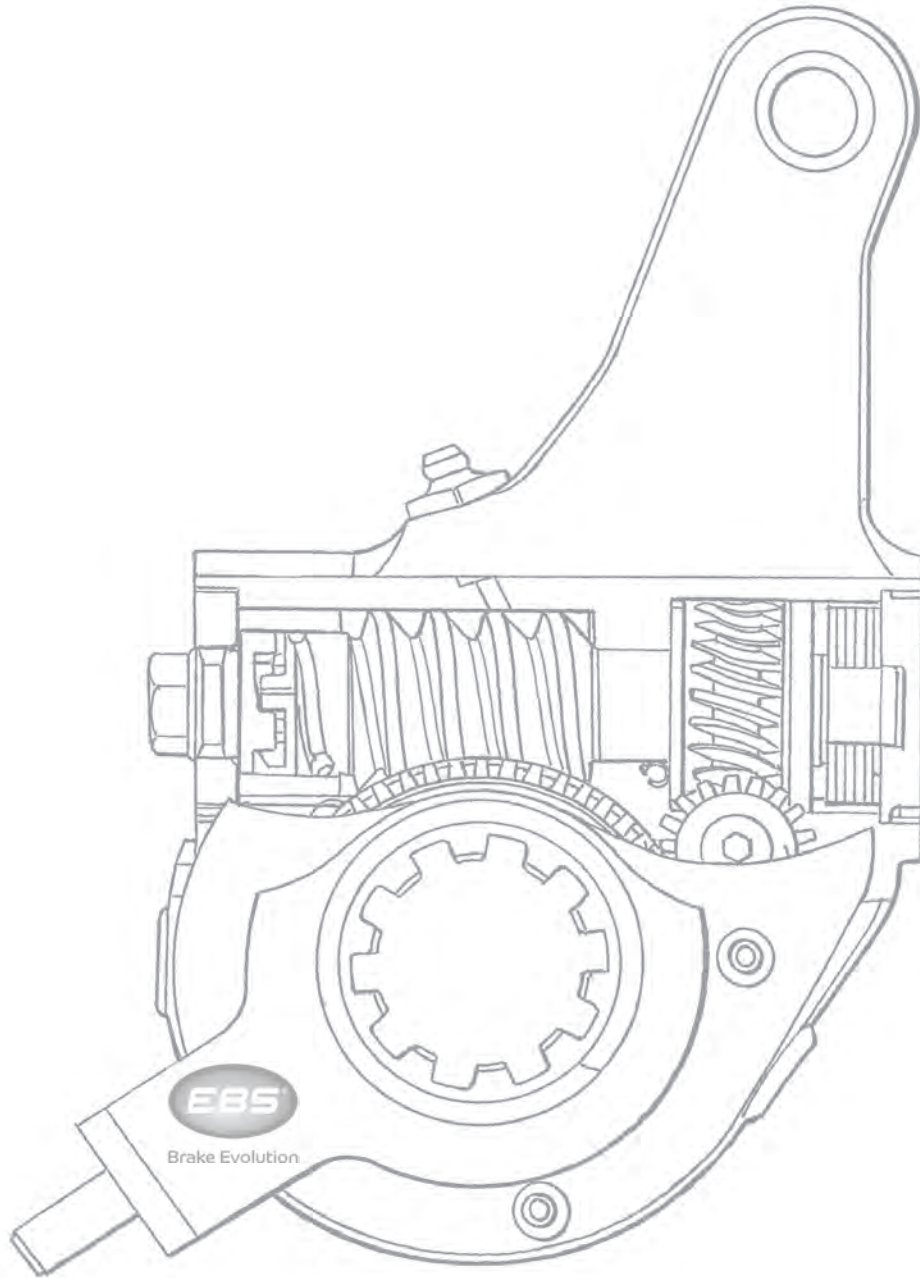

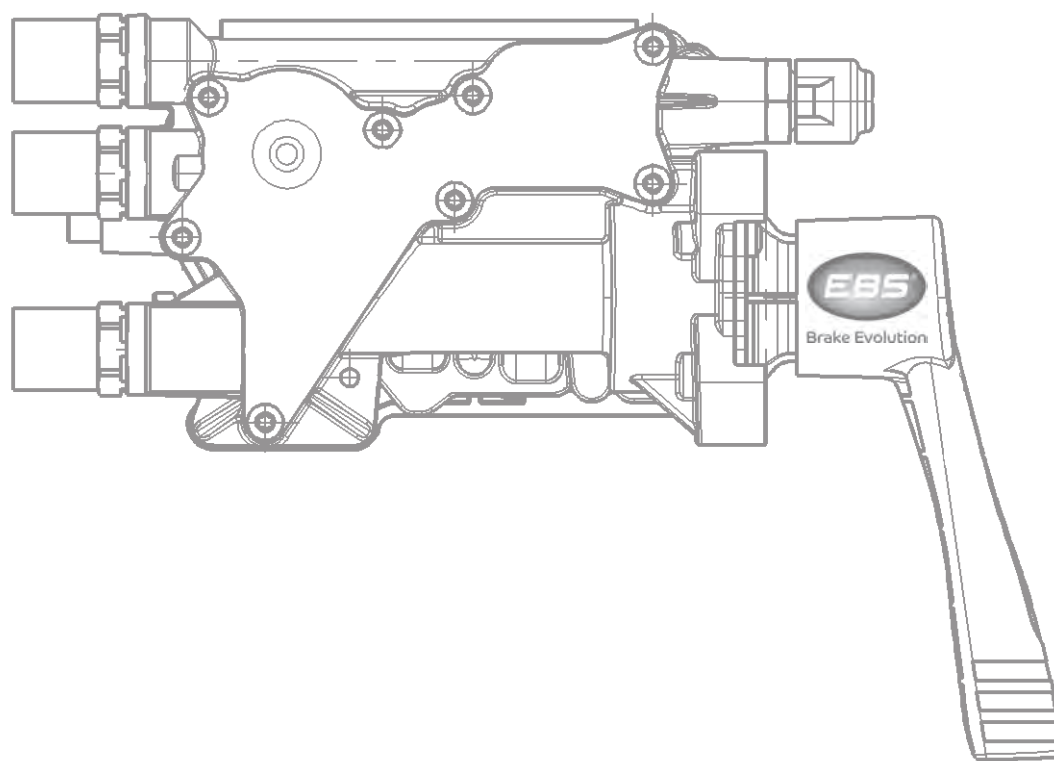
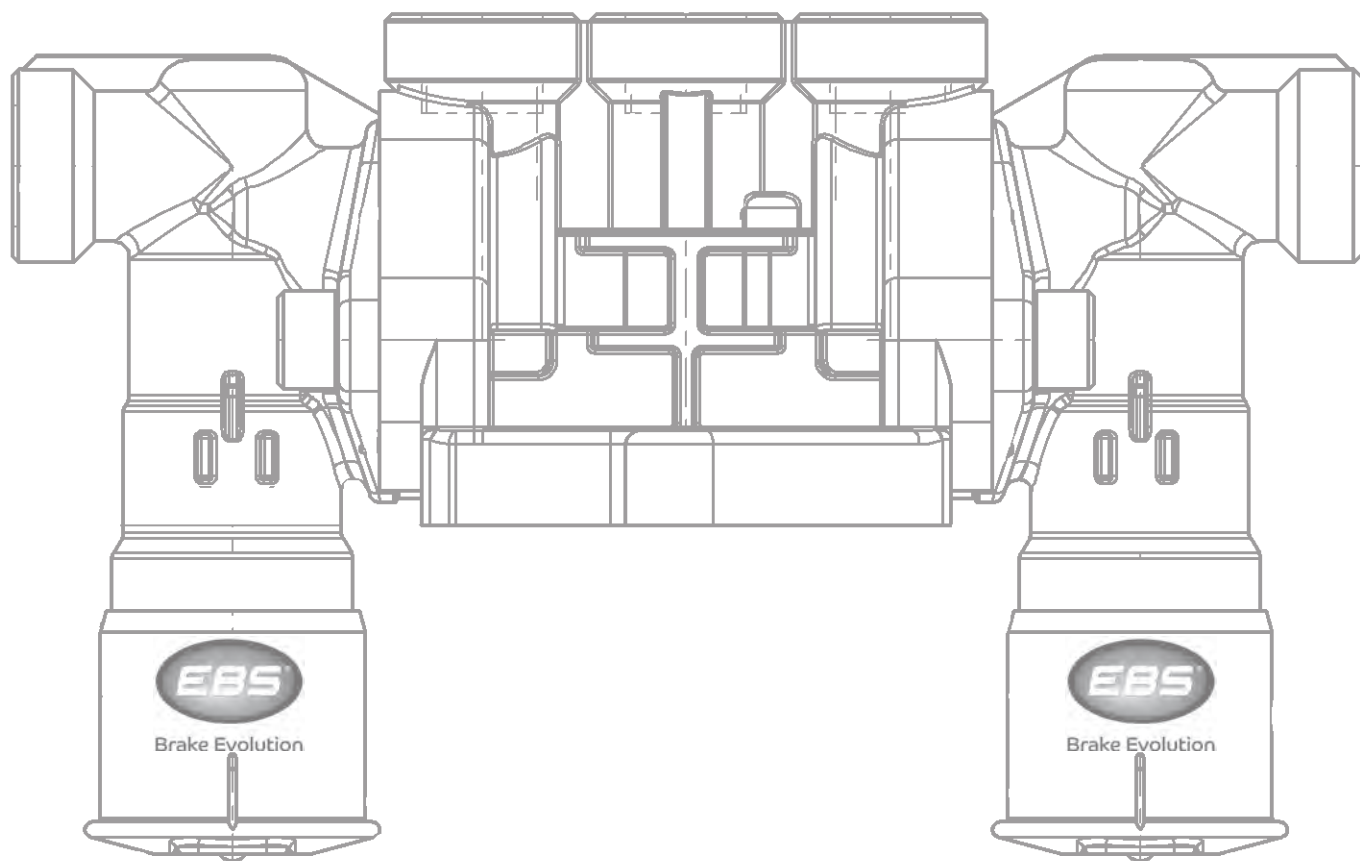

SUSPENSION VALVES



SUSPENSION VALVES - ACCEVAL





---		---		---		---		---	
Alternative Part No	LS1500	Alternative Part No	LS1500-10	Alternative Part No	LS2000	Alternative Part No	LS2000-10	Alternative Part No	LS2500
Lift Axle Valve Type: MCE1 Fittings To Suit: 8mm O/D Pipe		Lift Axle Valve Type: MCE1 Fittings To Suit: 10 mm O/D Pipe		Lift Axle Valve W/O Push / Pull Valve Type: MCE2 Fittings To Suit: 8mm O/D Pipe		Lift Axle Valve C/W Push / Pull Valve Type: MCE2 Fittings To Suit: 10mm O/D Pipe		Lift Axle Valve C/W Auto Drop Function Type: MCE3 Fittings To Suit: 8mm O/D Pipe	
---		---		---		---		---	
Alternative Part No	LS2500-10	Alternative Part No	VTN-1	Alternative Part No	VTN-1/10	Alternative Part No	VTP-1	Alternative Part No	VTP-1
Lift Axle Valve Type: MCE3 Fittings To Suit: 10mm O/D Pipe		3/2 Push Pull Valve Type: VTN-1 Fittings To Suit: 8mm O/D Pipe		3/2 Push Pull Valve Type: VTN-1 Fittings To Suit: 10mm O/D Pipe		3/2 Push Pull Valve & Pneumatic Pilot Type: VTP-1 Fittings To Suit: 8mm O/D Pipe		3/2 Push Pull Valve & Pneumatic Pilot Type: VTP-1 Fittings To Suit: 8mm O/D Pipe	

SUSPENSION VALVES - HALDEX

N6016		CAN USE: N6016 But that has no gaiter		N6017		---	
Alternative Part No	207012001 352018001 352029001	Alternative Part No	207012021	Alternative Part No	207013001 207013021 352019001 352019011 352026011	Alternative Part No	329007001
SHUNT VALVE C/W BLUE KNOB M16 PORTS 8.5 BAR		SHUNT VALVE C/W BLUE KNOB & RUBBER GAITER M16 PORTS 8.5 BAR		PARK VALVE C/W RED KNOB M16 PORTS 8.5 BAR		CONTROL VALVE M22 PORTS 8.0 BAR	
Repair Kit	0020527090 N6019K	Repair Kit	0020527090 N6020K	Repair Kit	0020526090	Repair Kit	---

SUSPENSION VALVES - HALDEX

26.03.1000		26.03.1001		26.03.2002		---	
							
Alternative Part No	338021001	Alternative Part No	338050101	Alternative Part No	338051101	Alternative Part No	338051102
RAISE / LOWER VALVE W/O Return to ride W/O Dead mans handle Ports:4 x M12 & 2 x M14		RAISE / LOWER VALVE ELEC- TRO-MAGNETIC Square electrical connection x 4 Pins		COLAS RAISE / LOWER VALVE C/W Return to ride C/W Dead mans handle C/W Push in fittings Handle @ 90 degrees 24V Ports = 8mm		COLAS RAISE / LOWER VALVE C/W Return to ride C/W Dead mans handle C/W Push in fittings Handle @ 90 degrees 24V Ports = 8mm	
Repair Kit	950338100	Repair Kit	EKGH.31	Repair Kit	EKGH.22.1 EKGH.22.1.L	Repair Kit	EKGH.22.1 EKGH.22.1.L

---		---		26.03.2001		---	
							
Alternative Part No	338051111	Alternative Part No	338051112	Alternative Part No	338051121	Alternative Part No	338051141
COLAS RAISE / LOWER VALVE C/W Return to ride C/W Dead mans handle C/W Push in fittings C/W 13-4 Pneumatic port Handle @ 90 degrees 24V Ports = 8mm		COLAS RAISE / LOWER VALVE C/W Return to ride C/W Dead mans handle C/W Push in fittings C/W 13-4 Pneumatic port Handle @ 90 degrees 24V Ports = 8mm		COLAS RAISE / LOWER VALVE C/W Return to ride C/W Dead mans handle C/W Push in fittings C/W Filter 24V Ports = 8mm		COLAS RAISE / LOWER VALVE C/W Return to ride C/W Dead mans handle C/W Push in fittings C/W Filter 24V Ports = 8mm	
Repair Kit	EKGH.22.1.L	Repair Kit	EKGH.22.1.L	Repair Kit	EKGH.22.1 EKGH.22.1.L	Repair Kit	EKGH.22.1 EKGH.22.1.L

---		---		---		---	
							
Alternative Part No	338052101	Alternative Part No	338053101	Alternative Part No	338054001	Alternative Part No	338054011
COLAS RAISE / LOWER VALVE W/O Return to ride C/W Dead mans handle C/W Push in fittings Ports = 8mm		COLAS RAISE / LOWER VALVE W/O Return to ride W/O Dead mans handle C/W Push in fittings Ports = 8mm		COLAS RAISE / LOWER VALVE C/W Return to ride C/W Dead mans handle C/W Push in fittings 24V Ports = 10mm		COLAS RAISE / LOWER VALVE C/W Return to ride C/W Dead mans handle C/W Push in fittings 24V Ports = 10mm	
Repair Kit	EKGH.22.1 EKGH.22.1.L	Repair Kit	EKGH.22.1 EKGH.22.1.L	Repair Kit	EKGH.22.1 EKGH.22.1.L	Repair Kit	EKGH.22.1 EKGH.22.1.L



SUSPENSION VALVES





SUSPENSION VALVES - HALDEX

Alternative Part No	338055101	Alternative Part No	338056001	Alternative Part No	338057101	Alternative Part No	338058101
COLAS RAISE / LOWER VALVE C/W Return to ride C/W Dead mans handle C/W Push in fittings C/W 13-4 Pneumatic port Ports = 8mm		COLAS RAISE / LOWER VALVE W/O Return to ride C/W Dead mans handle C/W Push in fittings 24V Ports = 10mm		COLAS RAISE / LOWER VALVE C/W Return to ride C/W Dead mans handle C/W Push in fittings 24V Ports = 8mm		COLAS RAISE / LOWER VALVE C/W Return to ride C/W Dead mans handle C/W Push in fittings 24V Ports = 8mm	
Repair Kit	EKGH.22.1 EKGH.22.1.L	Repair Kit	EKGH.22.1 EKGH.22.1.L	Repair Kit	EKGH.22.1 EKGH.22.1.L	Repair Kit	EKGH.22.1 EKGH.22.1.L
Alternative Part No	338058121	Alternative Part No	338059101	Alternative Part No	338061201	Alternative Part No	338062201
COLAS RAISE / LOWER VALVE C/W Return to ride C/W Dead mans handle C/W Push in fittings 24V Ports = 8mm		COLAS RAISE / LOWER VALVE W/O Return to ride C/W Dead mans handle C/W Push in fittings Ports = 8mm		COLAS RAISE / LOWER VALVE c/w Return to ride C/W Dead mans handle Roll Off Ports = 8mm		COLAS RAISE / LOWER VALVE c/w Return to ride C/W Dead mans handle Roll Off Ports = 2x8 + 1x12	
Repair Kit	EKGH.22.1 EKGH.22.1.L	Repair Kit	EKGH.22.1 EKGH.22.1.L	Repair Kit	---	Repair Kit	---
Alternative Part No	338062101	Alternative Part No	338071001 338071101	Alternative Part No	338071131	Alternative Part No	352006201
COLAS RAISE / LOWER VALVE C/W Return to ride C/W Dead mans handle C/W Push in fittings Roll on / Roll off 24V Ports = 2 x 8mm & 1 x 12mm		COLAS RAISE / LOWER VALVE C/W Return to ride C/W Dead mans handle C/W Push in fittings Roll off 24V Ports = 8mm		COLAS RAISE / LOWER VALVE C/W Return to ride C/W Dead mans handle C/W Push in fittings Roll off 24V Ports = 10mm		RELEASE VALVE C/W BLACK ROUND BUTTON M22 PORTS 8.0 BAR	
Repair Kit	950338036 EKGH.22.1.J	Repair Kit	950338038 EKGH.22.1.K	Repair Kit	950338038	Repair Kit	EKGH.22.1 EKGH.22.1.L

SUSPENSION VALVES - HALDEX

---		---		26.03.3001		26.03.1003	
							
Alternative Part No	352022001	Alternative Part No	352025011	Alternative Part No	352042001	Alternative Part No	352044001
CONTROL VALVE W/O KNOB M16 & M22 PORTS 2.5 BAR		SHUNT VALVE C/W BLACK KNOB M16 PORTS 8.5 BAR		PILOT VALVE C/W BLACK KNOB M16 & M22 PORTS 1.5 BAR		Park & Shunt Valve Combined c/w Red & Black Knob M16 Ports with non-return valve 8.5 BAR	
Repair Kit	---	Repair Kit	---	Repair Kit	---	Repair Kit	EKGH.22.1 EKGH.22.1.L

26.03.1002		26.03.1004		26.03.3002		---	
							
Alternative Part No	352045001	Alternative Part No	352046001	Alternative Part No	352053001	Alternative Part No	352067001 352067101
Park & Shunt Valve Combined c/w Red & Black Knob M16 Ports c/w non-return valve 8.5 BAR		Comes with Data Plate 028038309 Park & Shunt Valve Combined c/w Red & Black Knob M16 Ports c/w emergency function 8.5 BAR		3/2 Way Valve W/O Knob M16 & M22 Ports 2.0 BAR		TCM c/w pressure protection Port 1 = M22 Port 25 = M12 Ports 1-2,4,21, 22,23,24 = M16	
Repair Kit	027059409 027022209 028044309	Repair Kit	027059409 027022209 028044309	Repair Kit	---	Repair Kit	950352022 950352023

---		---		---		26.03.1005	
							
Alternative Part No	352067121	Alternative Part No	352067601	Alternative Part No	352075001	Alternative Part No	KN20615
TCM w/o pressure protection Port 1 = M22 Ports 1-2, 4, 21, 22 = M16		TCM c/w pressure protection Port 1, 12 = M22 Ports 1-2, 2, 4, 21, 23, 24 = M16 Port 22 = Plugged Port 25 = M12		TEM c/w pressure protection & shunt valve Ports 1 & 12 = M22 Ports 1-2 7 21 = M16 Port 2 = Plugged		Hand Operated Valve Manifold Dash Valve All Ports 1/4"	
Repair Kit	950352022 950352023	Repair Kit	950352017	Repair Kit	950352024	Repair Kit	---

SUSPENSION VALVES

SUSPENSION VALVES - KNORR BREMSE



26.02.1103		---		26.02.1122		26.02.1124	
Alternative Part No	AE1103 I60496	Alternative Part No	AE1109 I67763	Alternative Part No	AE1122 I83425	Alternative Part No	AE1124 AE1125 SEB00662
HEIGHT LIMITATION VALVE M12 Ports M8 Cable Connection Thread		3/2 CONTROL VALVE PUSH / PULL M12 Ports Black Knob		HEIGHT LIMITATION VALVE M12 Ports M8 Cable Connection Thread & 4.3mm Hole		LIFT AXLE VALVE M12 Ports W/O Auto Raise	
Repair Kit	---	Repair Kit	---	To Suit	02.4901.49.00	Repair Kit	EKKB.8

26.01.H012		---		26.01.H051		N6017	
Alternative Part No	AE4233 I136134	Alternative Part No	AE4246 I136125	Alternative Part No	AE4247 I136129	Alternative Part No	AE4262 I119802
MANOEUVRING VALVE M16 Ports		COMBINED PARK & SHUNT VALVE M22 Ports C/W Non-return Valve C/W Pinned Red Button		COMBINED PARK & SHUNT VALVE M16 Ports C/W Non-return Valve C/W Pinned Red Button		MANOEUVRING VALVE M16 Ports	
Repair Kit	---	Repair Kit	---	Repair Kit	---	Repair Kit	---

26.02.4311B		26.02.4311A		26.02.4311B		26.02.4370	
Alternative Part No	AE4311 K015380N00	Alternative Part No	AE4311 K015849N00	Alternative Part No	AE4311 K020123N00	Alternative Part No	AE4370 K025700N00
COMBINED PARK & SHUNT VALVE M16 & M22 Ports C/W Non-Return Valve		COMBINED PARK & SHUNT VALVE M16 & M22 Ports W/O Non-Return Valve		COMBINED PARK & SHUNT VALVE C/W 8mm & 12mm Push in Fittings C/W Non-Return Valve		COMBINED PARK & SHUNT VALVE W/O Non-Return Valve	
Repair Kit	EKKB.11	Repair Kit	EKKB.11	Repair Kit	EKKB.11	Repair Kit	---

SUSPENSION VALVES - RAISE / LOWER VALVES - KNORR BREMSE

26.02.2111		---		26.02.2115		---	
							
Alternative Part No	SV3111 I83153	Alternative Part No	SV3113 I86022	Alternative Part No	SV33115	Alternative Part No	SV3118 I86025
RAISE / LOWER VALVE M16 ports 2 x Valve Element W/O Spring Return To Stop Feature		RAISE / LOWER VALVE M16 ports 3 x Valve Element		RAISE / LOWER VALVE M16 ports 1 x Valve Element		RAISE / LOWER VALVE M16 Ports C/W 2 Levers 3 x Valve Elements	
Repair Kit	EKKB.22.C	Repair Kit	EKKB.22.C	Repair Kit	EKKB.22.C	Repair Kit	---

---		---		---		---	
							
Alternative Part No	SV3130 I90969	Alternative Part No	SV3133 I136043	Alternative Part No	SV3157 I92700	Alternative Part No	SV3158 I92737
RAISE / LOWER VALVE M16 Ports C/W 2 Levers 4 x Valve Elements		RAISE / LOWER VALVE M16 Ports 1 Lever 2 x Valve Elements		RAISE / LOWER VALVE M22 Voss & M16 Voss Ports Electrical Connections: Kostal		RAISE / LOWER VALVE M16 Ports Electrical Connections: Bayonet	
Repair Kit	---	Repair Kit	---	Repair Kit	EKKB.21	Repair Kit	EKKB.21

---		---		---		---	
							
Alternative Part No	SV3162 I136075	Alternative Part No	SV3200 I136145	Alternative Part No	SV3240 I136225 K002018	Alternative Part No	SV3241 I136226 K054888N00
RAISE / LOWER VALVE M16 Ports 1 x Valve Element W/O Spring Return To Stop Feature		RAISE / LOWER VALVE M16 Ports C/W Return To Ride Height C/W Spring Return To Stop Feature		RAISE / LOWER VALVE M16 & M22 Ports C/W Return To Ride Height		RAISE / LOWER VALVE C/W Return To Ride Height C/W Test Connector Electrical Connections: Bayonet	
Repair Kit	EKKB.22.C	Repair Kit	---	Repair Kit	---	Repair Kit	---

SUSPENSION VALVES

SUSPENSION VALVES - RAISE / LOWER VALVES - KNORR BREMSE

---		---		---	
Alternative Part No	SV3273 II36227 K054884N00	Alternative Part No	SV3293 K054882N00	Alternative Part No	SV3801 K022847N00
RAISE / LOWER VALVE C/W Return To Ride Height C/W Test Connector Electrical Connections: Bayonet		RAISE / LOWER VALVE C/W Return To Ride Height C/W Test Connector C/W Secondary Air Supply In Port 13 Electrical Connections: Bayonet		Only To Be Used With TEBS G2	
Repair Kit	EKKB.22.C	Repair Kit	---	Repair Kit	---

SUSPENSION VALVES - RAISE / LOWER VALVES - KNORR BREMSE





N6009		N6010		N6011M		N6012M		N6013M	
Alternative Part No	---	Alternative Part No	---	Alternative Part No	---	Alternative Part No	---	Alternative Part No	---
PARK VALVE C/W RED KNOB & RED BACK PLATE 1/4" BSP Ports		SHUNT VALVE C/W BLUE KNOB & BLUE BACK PLATE 1/4" BSP Ports		PARK VALVE C/W RED KNOB & RED BACK PLATE M16 Ports		SHUNT VALVE C/W BLUE KNOB & BLUE BACK PLATE M16 Ports		PARK/SHUNT VALVE C/W BLACK KNOB & GREEN BACK PLATE M16 Ports	
Repair Kit	N6014K	Repair Kit	N6015K N6018S	Repair Kit	N6014K	Repair Kit	N6015K N6018S	Repair Kit	---

SUSPENSION VALVES - MISCELLANEOUS

EBS Part No	Alternative Part No	Information	Image	Repair Kit
---	CM-9424F6	UNIVER RAISE / LOWER VALVE		---
---	10223312	POWNALL AUTO/MANUAL TRAILER PARK VALVE Main Ports: M16 Exhaust Port: 1/4 BSP		1022-RBK

SUSPENSION VALVES - WABCO

26.01.B000		26.01.B020		26.01.B021		26.01.C020	
							
Alternative Part No	4630220000	Alternative Part No	4630220200	Alternative Part No	4630220210	Alternative Part No	4630320200
DIRECTIONAL CONTROL VALVE M12 Ports 25 mm Stroke 10 BAR		DIRECTIONAL CONTROL VALVE M10 Ports 12.5mm Stroke 10 BAR		RAISE / LOWER VALVE M16 & M22 Ports C/W Return To Ride Height		ROTARY SLIDE VALVE M16 & M12 Ports C/W Check Valve 122mm Handle Length 10 BAR	
Repair Kit	EKWA.23.4A	Repair Kit	---	Repair Kit	EKWA.23.4A	Repair Kit	EKWA.22.4

26.01.C022		26.01.C023		26.01.C026		26.01.C120	
							
Alternative Part No	4630320220	Alternative Part No	4630320230	Alternative Part No	4630320260	Alternative Part No	4630321200
ROTARY SLIDE VALVE M12 Ports C/W Check Valve 122mm Handle Length 10 BAR		ROTARY SLIDE VALVE M12 Ports C/W Check Valve 122mm Handle Length 10 BAR		ROTARY SLIDE VALVE M12 Ports 122mm Handle Length 10 BAR		ROTARY SLIDE VALVE M12 Ports C/W Auto Stop W/O Check Valve 122mm Handle Length 8.5 BAR	
Repair Kit	EKWA.22.4	Repair Kit	EKWA.22.4	Repair Kit	EKWA.22.4	Repair Kit	EKWA.22.4

---		26.01.C220		---		26.03.1000	
							
Alternative Part No	4630321300	Alternative Part No	4630322200	Alternative Part No	4630340050	Alternative Part No	4630740000
ROTARY SLIDE VALVE M16 & M12 Ports W/O Check Valve 122mm Handle Length 8.5 BAR		ROTARY SLIDE VALVE M12 Ports 122mm Handle Length 8.5 BAR		RELEASE VALVE Ports 1 & 2: M22 Port 3-4: M16 10 BAR		ROTARY SLIDE VALVE M12 Ports 10 BAR	
Repair Kit	EKWA.22.4	Repair Kit	EKWA.22.4	Repair Kit	---	Repair Kit	---

SUSPENSION VALVES

SUSPENSION VALVES - WABCO

26.01.E000		26.01.E001		26.01.E010		26.01.E011	
Alternative Part No	4630840000	Alternative Part No	4630840010	Alternative Part No	4630840100	Alternative Part No	4630840110
LIFT AXLE CONTROL VALVE Manual Actuation Ports 1, 21, 22, 23, 24, 41 & 42 = M16 Port 20 = M22		LIFT AXLE CONTROL VALVE Manual Actuation Ports 1, 21, 22, 23, 24, 41 & 42 = M16 Port 20 = M22		LIFT AXLE CONTROL VALVE Electrical Actuation Ports 1, 21, 22, 23, 24, 41 & 42 = M16 Port 20 = M22		LIFT AXLE CONTROL VALVE Electrical Actuation Ports 1, 21, 22, 23, 24, 41 & 42 = M16 Port 20 = M22	
Repair Kit	EKWA.22.3	Repair Kit	EKWA.22.3	Repair Kit	EKWA.22.3	Repair Kit	EKWA.22.3
---		---		26.01.E031		26.01.E041	
Alternative Part No	4630840200	Alternative Part No	4630840210	Alternative Part No	4630840300 4630840310	Alternative Part No	4630840410
LIFT AXLE CONTROL VALVE Auto Actuation Ports 1, 21, 22, 23, 24, 41 & 42 = M16 Port 20 = M22		LIFT AXLE CONTROL VALVE Auto Actuation AS 4630840200 BUT THIS HAS LONGER MOUNTING BOLTS		LIFT AXLE CONTROL VALVE Electrical Connector: DIN72585 W/O Fittings		LIFT AXLE CONTROL VALVE Electrical Connector: DIN72585 C/W Push-in-fittings: 8x1	
Repair Kit		Repair Kit		SINGLE CIRCUIT		SINGLE CIRCUIT	
Repair Kit	EKWA.22.3	Repair Kit	EKWA.22.3	Repair Kit	EKWA.22.31	Repair Kit	EKWA.22.31
26.01.E100		---		26.01.M020		26.01.M023	
Alternative Part No	4630841000	Alternative Part No	4630900120 338058121	Alternative Part No	4630900200	Alternative Part No	4630900230
LIFT AXLE CONTROL VALVE Electrical Connector: DIN72585		TASC C/W Return To Ride C/W Lower & Lock C/W Test Connection W/O Fittings		TASC C/W Return To Ride C/W Lower & Lock C/W Test Connection C/W Fittings		TASC C/W Return To Ride C/W Lower & Lock W/O Test Connection W/O Fittings	
DUAL CIRCUIT		SINGLE CIRCUIT		DUAL CIRCUIT		DUAL CIRCUIT	
Repair Kit	EKWA.22.31	Repair Kit	4630909202 4630909212	Repair Kit	4630909202 4630909212	Repair Kit	4630909202 4630909212

SUSPENSION VALVES - WABCO

26.01.M312		26.01.M316		---		---	
							
Alternative Part No	4630903120	Alternative Part No	4630903160	Alternative Part No	4630905000	Alternative Part No	4630905020
TASC With Test Connection Without Fittings		ETASC C/W Test Connection C/W Fittings		ETASC C/W Lock In Lowering C/W Test Connection C/W Fittings		ETASC M16 Ports C/W Lock In Lowering C/W Test Connection	
DUAL CIRCUIT		DUAL CIRCUIT		DUAL CIRCUIT		DUAL CIRCUIT	
Repair Kit	---	Repair Kit	---	Repair Kit	---	Repair Kit	---

---		---		26.01.G010		26.01.G011	
							
Alternative Part No	4630905030	Alternative Part No	4630905030	Alternative Part No	4756040100	Alternative Part No	4756040110
ETASC C/W Lock In Lifting C/W Lock In Lowering C/W Test Connection		LOAD SENSING VALVE Manual Operation M22 Ports 10 BAR		LOAD SENSING VALVE Manual Operation M22 Ports 10 BAR		LOAD SENSING VALVE Manual Operation M22 Ports 10 BAR	
DUAL CIRCUIT							
Repair Kit	---	Repair Kit	EKWA.36	Repair Kit	EKWA.36	Repair Kit	EKWA.36

26.01.G012		26.01.G013		26.01.H012		26.01.H013	
							
Alternative Part No	4756040120	Alternative Part No	4756040130	Alternative Part No	9630010120 AE4233	Alternative Part No	9630010130
LOAD SENSING VALVE Manual Operation W/O Release Position M22 Ports 10 BAR		LOAD SENSING VALVE Manual Operation W/O Release Position M22 Ports 10 BAR		TRAILER RELEASE VALVE Black Knob M16 Ports 8.5 BAR		TRAILER RELEASE VALVE Black Knob M22 Ports 8.5 BAR	
Repair Kit	EKWA.36	Repair Kit	EKWA.36	Repair Kit	---	Repair Kit	---

SUSPENSION VALVES

SUSPENSION VALVES - WABCO

---		26.01.H051		26.01.H052		26.01.J001	
							
Alternative Part No	9630010160	Alternative Part No	9630010510	Alternative Part No	9630010520	Alternative Part No	9630060010
TRAILER RELEASE VALVE RED Knob M16 Ports 8.5 BAR		TRAILER RELEASE VALVE Black & Red Knobs C/W Non-return valve M16 Ports 8.5 BAR		TRAILER RELEASE VALVE Black & Red Knobs W/O Non- return valve M16 Ports 8.5 BAR		TTRAILER RELEASE VALVE Black Knob M16 Ports 8.5 BAR	
Repair Kit	---	Repair Kit	EKWA.11	Repair Kit	EKWA.11	Repair Kit	---

26.01.J003		26.01.J005		26.01.J006		---	
							
Alternative Part No	9630060030	Alternative Part No	9630060050	Alternative Part No	9630060060	Alternative Part No	9630060080
TRAILER RELEASE VALVE Red Knob M16 Ports 8.5 BAR		TRAILER RELEASE VALVE Green Knob M16 Ports 8.5 BAR		TRAILER RELEASE VALVE Yellow Knob M16 Ports 8.5 BAR		TRAILER RELEASE VALVE White Knob M16 Ports 8.5 BAR	
Repair Kit	---	Repair Kit	---	Repair Kit	---	Repair Kit	---

26.01.K002		26.01.2900		26.01.2910		26.01.2912	
							
Alternative Part No	9640010020	Alternative Part No	9710029000 9710029020	Alternative Part No	9710029100	Alternative Part No	9710029120
HEIGHT LIMITING VALVE M12 Ports 12 BAR		PARK RELEASE EMERGENCY VALVE M16 Ports W/O Fittings 8.5 BAR		PARK RELEASE EMERGENCY VALVE M16 Ports C/W Fittings 8.5 BAR		PARK RELEASE EMERGENCY VALVE M16 Ports C/W Fittings 8.5 BAR	
Repair Kit	EKWA.1.2	Repair Kit	EKWA.56.6	Repair Kit	EKWA.56.6	Repair Kit	EKWA.56.6

SUSPENSION VALVES - WABCO

26.01.2913	
	
Alternative Part No	9710029130
PARK RELEASE EMERGENCY VALVE M16 Ports C/W Fittings 8.5 BAR	
Repair Kit	EKWA.56.6

SUSPENSION VALVES

EBS HALDEX REPAIR KITS

EKGH.22.1	
	

EKGH.22.1.J	
	

EKGH.22.1.K	
	

EKGH.22.1.L	
	

950352110	EKGH.22.2
	

950352111	EKGH.22.3
	

EKGH.31	
	

950338036	
	

EBS HALDEX REPAIR KITS

<p>950338038</p>	<p>950338100</p>	<p>950352017</p> <p>The rear of the park valve has shuttle valve & cover</p>	<p>950352022</p>
<p>950352023</p>	<p>950352024</p> <p>The rear of the park valve has NO shuttle valve & cover</p>	<p>0020526090</p>	<p>0020527090</p>
<p>0020530090</p>	<p>027022209</p>	<p>027059409</p>	<p>028044309</p>

EBS KNORR BREMSE REPAIR KITS

<p>EKKB.8</p>	<p>EKKB.11</p>	<p>EKKB.21</p>	<p>EKKB.22.C</p>
<p>02.4901.49.00</p>			

EBS MERITOR (ROR) STYLE REPAIR KITS



EBS WABCO REPAIR KITS



SUSPENSION VALVES

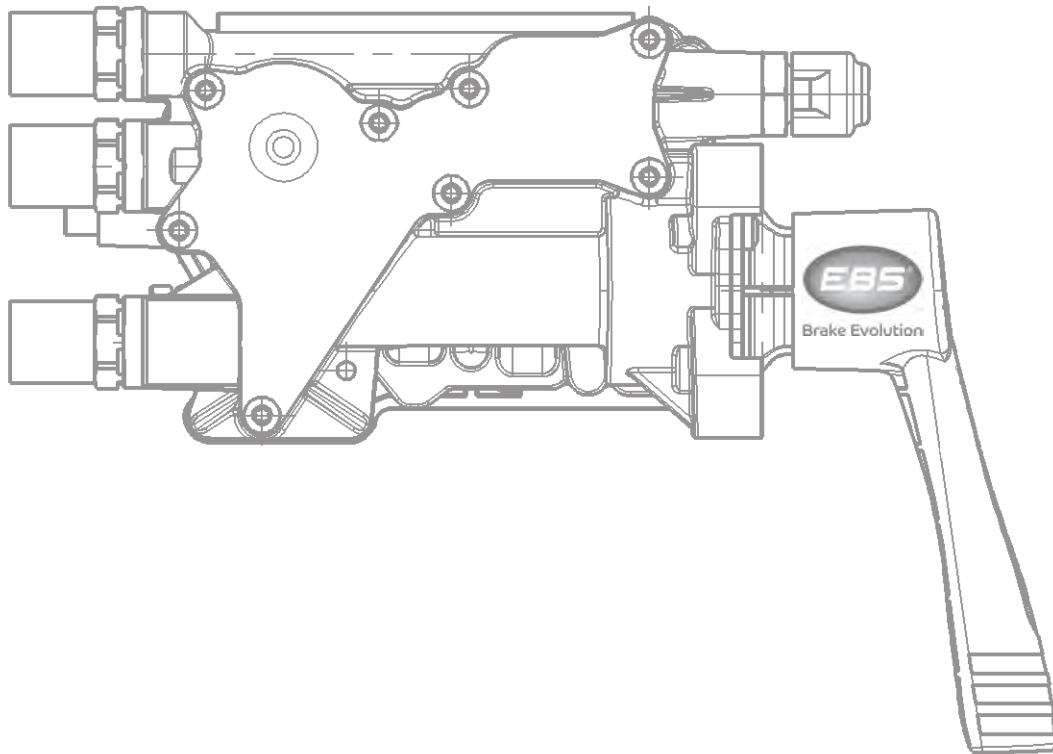
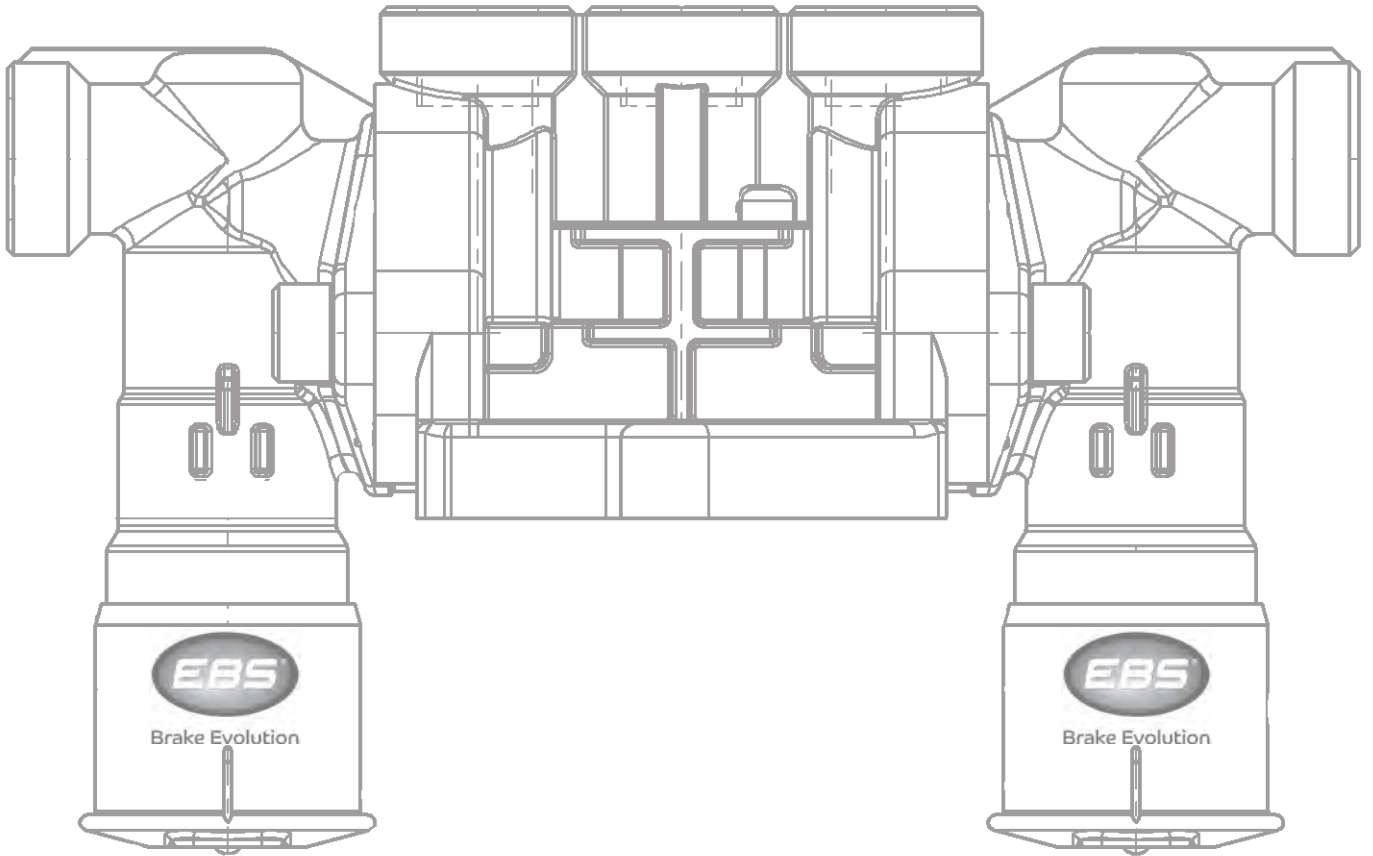

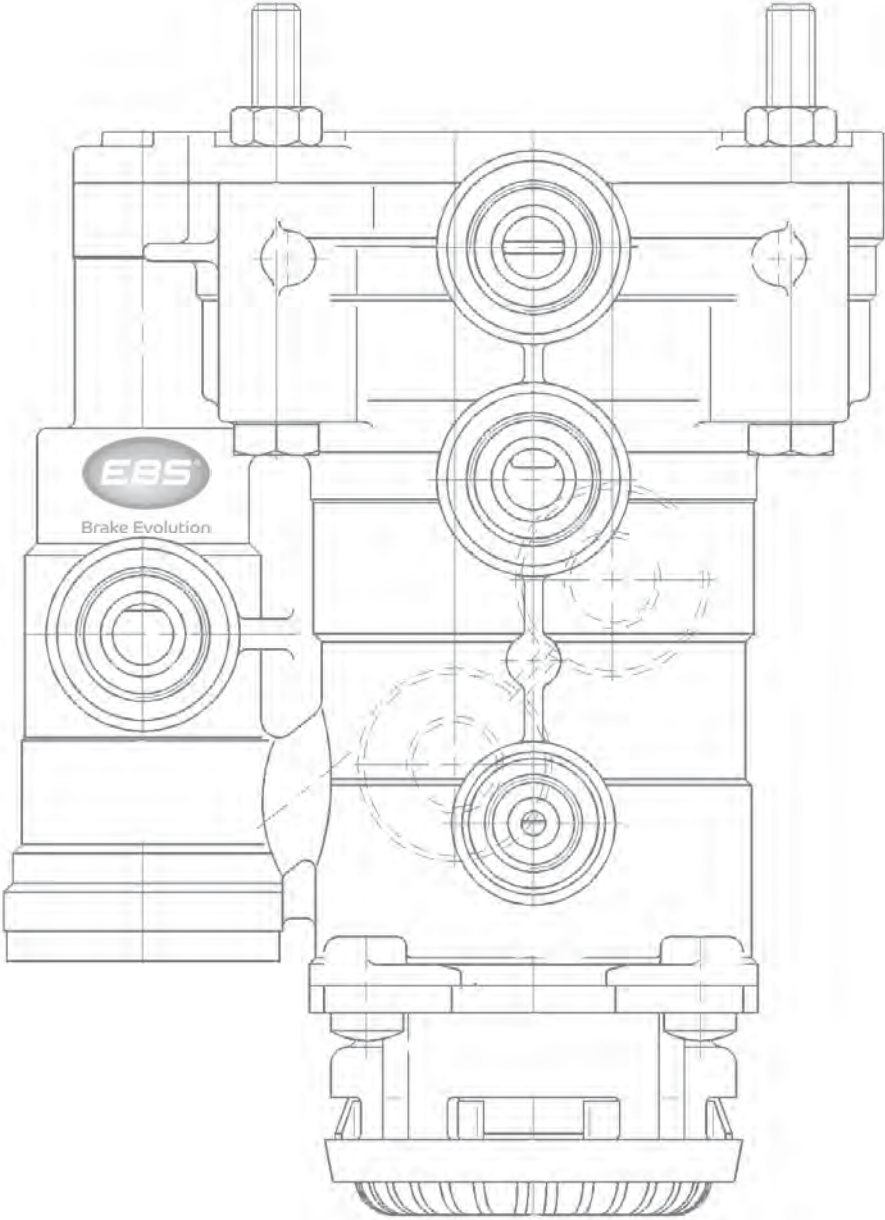

TRAILER CONTROL VALVES

TRAILER CONTROL VALVES - HALDEX

---		---		---		---	
Alternative Part No	329020201	Alternative Part No	329020241	Alternative Part No	329020261	Alternative Part No	329024071
Double Circuit 6 Bar Flat Control Lever		Double Circuit 6 Bar Flat Control Lever		Double Circuit 6 Bar Flat Control Lever		Intergrated 2/2 Way Throttle Valve W/O Control Lever	
Repair Kit	---	Repair Kit	---	Repair Kit	---	Repair Kit	---

---		---		27.03.1001	
Alternative Part No	355071001	Alternative Part No	355087001	Alternative Part No	355094001
C/W Pressure Lead C/W Plug Connection C/W Cut-Off Valve		C/W Pressure Lead C/W Plug Connection C/W Cut-Off Valve C/W Silencer		Double Circuit 6 Bar Looped Control Lever	
Repair Kit	EKGH.58.2	Repair Kit	EKGH.58.4	Repair Kit	EKGH.58.4





TRAILER CONTROL VALVES - KNORR BREMSE

							
Alternative Part No	AB2762	Alternative Part No	AB2774 SEB00310	Alternative Part No	AB2777	Alternative Part No	AB2783
M16 Ports		M16 Ports		M16 Ports		M16 Ports C/W Integral Supply Dump	
Repair Kit	EKKB.6 or SEKKB.6	Repair Kit	EKKB.6 or SEKKB.6	Repair Kit	EKKB.6 or SEKKB.6	Repair Kit	EKKB.6 or SEKKB.6



---		27.01.3520		---		---	
Alternative Part No	AB2793	Alternative Part No	AB2795 177618	Alternative Part No	AB2798	Alternative Part No	AB2802
---		27.02.1000		---		---	
Alternative Part No	AB2810	Alternative Part No	AB2831	Alternative Part No	AB2835		
M16 Ports C/W Integral Supply Dump							
Repair Kit		EKKB.6, SEKKB.6					

27.01.5006		---		---		---	
							
Alternative Part No	AB2840 193362	Alternative Part No	AB2846 1115332	Alternative Part No	AB2851	Alternative Part No	AC590A
M16 Voss & M22 Voss Ports C/W Integral Supply Dump				M22 Ports W/O Predominance		M16 Ports W/O Predominance	
Repair Kit	EKKB.6.2			Repair Kit	EKMM.11.1		

---		---		27.07.1003		27.07.1000		27.07.1001			
											
Alternative Part No	AC595A	Alternative Part No	AC595F	Alternative Part No	AC596A	Alternative Part No	AC597A	Alternative Part No	AC597B AC597BA		
M16 Ports C/W Integral Supply Dump				M22 Ports C/W Integral Supply Dump C/W Internal Silencer				M16 Ports C/W Integral Supply Dump C/W Internal Silencer			
Repair Kit	EKMM.11			Repair Kit	EKMM.58.5			Repair Kit	EKMM.58.5		

For Silencers please see pages 90.8 & 90.9

TRAILER CONTROL VALVES

TRAILER CONTROL VALVES - KNORR BREMSE

27.07.1007		27.07.1004		27.07.1005		27.07.1006		27.07.1002	
Alternative Part No	AC597C	Alternative Part No	AC598A	Alternative Part No	AC598B	Alternative Part No	AC598C	Alternative Part No	AC599A
M16 Ports C/W Integral Supply Dump C/W Internal Silencer		M22 Ports C/W Integral Supply Dump C/W Internal Silencer							
Repair Kit	EKMM.58.5	Repair Kit		EKMM.58.5					

17.02.0623		R17.02.0624		27.06.1000		R27.06.1007	
Alternative Part No	K020623N50 K000917N50	Alternative Part No	K020624N50 K000918N50	Alternative Part No	KY1732/2	Alternative Part No	KY1738/2
EBS 5X For: MAN RENAULT SCANIA VOLVO		EBS 5X For: VOLVO		3/8" NPTF Ports C/W Integral Supply Dump		3/8" NPTF Ports C/W Integral Supply Dump	
Repair Kit	EKKB.49.3	Repair Kit		Repair Kit		Repair Kit	

---		27.06.1002		27.06.1003		27.06.1004	
Alternative Part No	KY1772/2	Alternative Part No	KY2106/3	Alternative Part No	KY2106/4	Alternative Part No	KY2106/5 KY2106/6
3/8" NPTF Ports Predominance: W/O		3/8" NPTF Ports C/W Integral Supply Dump Predominance: 0.5 Bar		M16 Ports C/W Integral Supply Dump Predominance: 0.5 Bar		3/8" NPTF Ports C/W Integral Supply Dump Predominance: 0.25 Bar	
Repair Kit	---	Repair Kit		Repair Kit		Repair Kit	

For Silencers please see pages 90.8 & 90.9

TRAILER CONTROL VALVES - KNORR BREMSE

27.06.1005		---		---		27.01.3402	
							
Alternative Part No	KY2106/8	Alternative Part No	KY2108/1	Alternative Part No	0481061004000	Alternative Part No	0481061005000
3/8" NPTF Ports C/W Integral Supply Dump Predominance: 0.1 Bar		M16 Ports Predominance: 0 Bar		M16 Ports Predominance: 0.0 - 0.2 Bar		M16 Ports Predominance: W/O	
Repair Kit	---	Repair Kit	---	Repair Kit	EKBO.1.3	Repair Kit	EKBO.1.3

---		---		---		27.01.3423	
							
Alternative Part No	0481061019000	Alternative Part No	0481061020000	Alternative Part No	0481061023000	Alternative Part No	0481061025000
M16 Ports Predominance: 0.0 - 0.25 Bar		M16 Ports Predominance: 0.0 - 0.2 Bar		M16 Ports Predominance: 0.4 - 0.6 Bar		M16 Ports Predominance: 0.2 - 0.4 Bar	
Repair Kit	EKBO.1.3	Repair Kit	EKBO.1.6	Repair Kit	EKBO.1.6	Repair Kit	EKBO.1.4 SEKBO.1.4

---		---		27.04.1004		---	
							
Alternative Part No	0481061205000	Alternative Part No	0481061209000	Alternative Part No	0481061210000	Alternative Part No	0481061212000
M16 Ports Predominance: 0.4 - 0.6 Bar		M16 Ports Predominance: 0.25 - 0.4 Bar		M16 Ports. Predominance: 0.25 - 0.4 Bar		M16 Ports C/W Integral Supply Dump Predominance: 0.2 - 0.4 Bar	
Repair Kit	EKBO.1.3	Repair Kit	EKBO.1.6 or EKBO.1.6.C	Repair Kit	EKBO.1.6 or EKBO.1.6.C	Repair Kit	EKBO.1.4 SEKBO.1.4

For Silencers please see pages 90.8 & 90.9

TRAILER CONTROL VALVES

TRAILER CONTROL VALVES - KNORR BREMSE

---		---		---		27.04.1001	
Alternative Part No	0481061213000 0481061214000	Alternative Part No	0481061215000	Alternative Part No	0481061220000	Alternative Part No	0481061226000
M16 Ports C/W Integral Supply Dump Predominance: W/O		M16 Ports C/W Integral Supply Dump Predominance: 0.0 - 0.5 Bar		M16 Ports C/W Integral Supply Dump Predominance: 0.0 - 0.2 Bar		M16 Ports C/W Integral Supply Dump Predominance: 0.1 - 0.3 Bar	
Repair Kit	EKBO.1.4 SEKBO.1.4	Repair Kit	EKBO.1.4 SEKBO.1.4	Repair Kit	EKBO.1.6 or EKBO.1.6.C	Repair Kit	EKBO.1.6 or EKBO.1.6.C
---		27.04.1002		---		27.04.1003	
Alternative Part No	0481061228000	Alternative Part No	0481061230000	Alternative Part No	0481061231000	Alternative Part No	0481061233000
M16 Ports C/W Integral Supply Dump Predominance: 0.0 - 0.25 Bar		M16 Ports C/W Integral Supply Dump Predominance: 0.5 - 0.8 Bar		M16 Ports C/W Integral Supply Dump Predominance: 1.0 - 1.3 Bar		M16 Ports C/W Integral Supply Dump Predominance: 0.0 - 0.2 Bar	
Repair Kit	EKBO.1.6 or EKBO.1.6.C	Repair Kit	EKBO.1.4 SEKBO.1.4	Repair Kit	EKBO.1.4 SEKBO.1.4	Repair Kit	EKBO.1.6 or EKBO.1.6.C
27.06.1003		27.06.1006		27.04.1000		---	
Alternative Part No	0481061245000	Alternative Part No	1188743	Alternative Part No	0481061219000* 0481061225000** 0481061248000***	1194101	
M16 Ports C/W Integral Supply Dump Predominance: 0.4 - 0.6 Bar		M16 Ports C/W Integral Supply Dump C/W Internal Silencer Predominance: W/O		M16 Ports C/W Integral Supply Dump Predominance: *0.0 - 0.25 Bar **0.4 - 0.6 Bar ***0.3 - 0.5 Bar		M16 Ports C/W Integral Supply Dump. C/W Internal Silencer. C/W Differential Feature. Predominance: W/O	
Repair Kit	EKBO.1.6 or EKBO.1.6.C	Repair Kit	---	Repair Kit	EKBO.1.6 or EKBO.1.6.C	---	

For Silencers please see pages 90.8 & 90.9

TRAILER CONTROL VALVES - WABCO

---		---		---		---	
							
Alternative Part No	4700150510	Alternative Part No	4700150960	Alternative Part No	4700152140	Alternative Part No	4700152550
M16 Ports		M16 Ports		M16 Ports M10 Ports M12 Ports		M16 Ports M10 Ports M12 Ports	
Repair Kit	---	Repair Kit	---	Repair Kit	---	Repair Kit	---

---		---		27.01.1110		---	
							
Alternative Part No	4700155510	Alternative Part No	4712000080	Alternative Part No	4712001100	Alternative Part No	4714010100
M16 Ports		M22 Ports		M22 Ports		M22 Ports	
Repair Kit	---	Repair Kit	EKWA.30.3	Repair Kit	EKWA.30.3	Repair Kit	EKWA.30

27.01.2002		27.01.2002		27.01.3000		27.01.3007	
							
Alternative Part No	480 204 0010	Alternative Part No	4802040020 4802040030	Alternative Part No	9730020000	Alternative Part No	9730020070
M16 & M22 Ports		M16 & M22 Ports		M22 Ports Predominance: Adjustable 0.6 Bar		M22 Ports Predominance: Adjustable 0.6 Bar	
Repair Kit	EKWA.58.8 EKWA.58.S1	Repair Kit	EKWA.58.10 EKWA.58.S1	Repair Kit	EKWA.58.1 SEKWA.58.1	Repair Kit	EKWA.58.1 SEKWA.58.1

For Silencers please see pages 90.8 & 90.9

TRAILER CONTROL VALVES

TRAILER CONTROL VALVES - WABCO

---		27.01.3022		27.01.3013		27.01.3070	
Alternative Part No	9730020100	Alternative Part No	9730020220	Alternative Part No	9730020130	Alternative Part No	9730020700
M22 Ports Predominance: Adjustable 0.5 Bar		M22 Ports Predominance: Adjustable 0.2 Bar		M22 Ports Predominance: Adjustable 0.6 Bar		M22 Ports Predominance: Adjustable 0.6 Bar	
Repair Kit	EKWA.58.1 SEKWA.58.1	Repair Kit	EKWA.58.1 SEKWA.58.1	Repair Kit	EKWA.58.1 SEKWA.58.1	Repair Kit	EKWA.58.1 SEKWA.58.1
27.01.3402		27.01.3403		27.01.3406		27.01.3409	
Alternative Part No	9730024020 9730024300	Alternative Part No	9730024030	Alternative Part No	9730024060	Alternative Part No	9730024090
M16 Ports Predominance: Not Adjustable		M16 Ports Predominance: Adjustable 0.2 Bar		M16 Ports Predominance: Not Adjustable 0.5 Bar		M16 Ports Predominance: Adjustable 0.2 Bar	
Repair Kit	EKWA.58.1 SEKWA.58.1	Repair Kit	EKWA.58.1 SEKWA.58.1	Repair Kit	EKWA.58.1 SEKWA.58.1	Repair Kit	EKWA.58.1 SEKWA.58.1
---		---		---		27.01.3422	
Alternative Part No	9730021200	Alternative Part No	9730024180	Alternative Part No	9730024190	Alternative Part No	9730024220
Predominance: Adjustable 8 Bar		M16 Ports Predominance: Adjustable 1 Bar		M16 Ports Predominance: Adjustable 0.4 Bar		M16 Ports Predominance: Adjustable	
Repair Kit	EKWA.58.1 SEKWA.58.1	Repair Kit	EKWA.58.1 SEKWA.58.1	Repair Kit	EKWA.58.1 SEKWA.58.1	Repair Kit	EKWA.58.1 SEKWA.58.1

For Silencers please see pages 90.8 & 90.9

TRAILER CONTROL VALVES - WABCO

27.01.3423		27.01.3425		27.01.3450		27.01.3500	
							
Alternative Part No	9730024230	Alternative Part No	9730024250	Alternative Part No	9730024500	Alternative Part No	9730025000
M16 Ports Predominance: Adjustable 0.3 Bar		M16 Ports Predominance: Adjustable Snap-on Exhaust 0.3 Bar		M16 Ports, M22 Exhaust, Predominance: Not adjustable		M16 Ports Predominance: Not Adjustable	
Repair Kit	EKWA.58.1 SEKWA.58.1	Repair Kit	EKWA.58.1 SEKWA.58.1	Repair Kit	EKWA.58.1 SEKWA.58.1	Repair Kit	EKWA.58.1 SEKWA.58.1
27.01.3501		---		27.01.3520		27.01.3521	
							
Alternative Part No	9730025010	Alternative Part No	9730025050	Alternative Part No	9730025200	Alternative Part No	9730025210
M16 Ports Predominance: Adjustable 0.2 Bar		M16 Ports Predominance: Adjustable		M16 Ports Predominance: Not Adjustable		M16 Ports Predominance: Adjustable 0.2 Bar	
Repair Kit	EKWA.58.1 SEKWA.58.1	Repair Kit	EKWA.58.1 SEKWA.58.1	Repair Kit	EKWA.58.1 SEKWA.58.1	Repair Kit	EKWA.58.1 SEKWA.58.1
27.01.3522		27.01.3523		27.01.3528		27.01.3532	
							
Alternative Part No	9730025220	Alternative Part No	9730025230	Alternative Part No	9730025280	Alternative Part No	9730025320
M16 Ports Predominance: Adjustable 0.5 Bar		M16 Ports Predominance: Adjustable 1.0 Bar		M16 Ports Predominance: Not Adjustable		M16 Ports Predominance: Adjustable 0.7 Bar	
Repair Kit	EKWA.58.1 SEKWA.58.1	Repair Kit	EKWA.58.1 SEKWA.58.1	Repair Kit	EKWA.58.1 SEKWA.58.1	Repair Kit	EKWA.58.1 SEKWA.58.1

For Silencers please see pages 90.8 & 90.9

TRAILER CONTROL VALVES

TRAILER CONTROL VALVES - WABCO

27.01.3535		27.01.3521		---		R27.01.4005	
Alternative Part No	9730025350	Alternative Part No	9730025390	Alternative Part No	9730026200	Alternative Part No	9730080050
M16 Ports Predominance: Adjustable Snap-on Exhaust		M16 Ports Predominance: Adjustable 0.3 Bar		M16 Ports Predominance: Adjustable 0.55 Bar		M16 Ports	
Repair Kit	EKWA.58.1 SEKWA.58.1	Repair Kit	EKWA.58.1 SEKWA.58.1	Repair Kit	EKWA.58.1 SEKWA.58.1	Repair Kit	EKWA.58.4
R27.01.4007		27.01.5001		27.01.5002		27.01.5005	
Alternative Part No	9730080070	Alternative Part No	9730090010	Alternative Part No	9730090020	Alternative Part No	9730090050
M16 & M22 Voss Ports		M16 & M22 Voss Ports		M16 Voss Ports		M16 & M22 Voss Ports	
Repair Kit	EKWA.58.4	Repair Kit	EKWA.58.5 or EKWA.58.5C	Repair Kit	EKWA.58.5 or EKWA.58.5C	Repair Kit	EKWA.58.5 or EKWA.58.5C
27.01.5006		27.01.5007		---		27.01.5010	
Alternative Part No	9730090060	Alternative Part No	9730090070	Alternative Part No	9730090090	Alternative Part No	9730090100
M16 & M22 Voss Ports C/W Silencer		M16 & M22 Voss Ports C/W Silencer		M16 & M22 Ports C/W Silencer		M16 Ports C/W Silencer	
Repair Kit	EKWA.58.5 or EKWA.58.5C	Repair Kit	EKWA.58.5 or EKWA.58.5C	Repair Kit	EKWA.58.5 or EKWA.58.5C	Repair Kit	EKWA.58.5 or EKWA.58.5C

For Silencers please see pages 90.8 & 90.9

TRAILER CONTROL VALVES - WABCO

27.01.5013		27.01.5015		27.01.5016		27.01.5018	
							
Alternative Part No	9730090130	Alternative Part No	9730090150	Alternative Part No	9730090160	Alternative Part No	9730090180
M16 Ports		M16 Ports C/W Silencer		M22 Ports C/W Silencer		M16 Ports	
Repair Kit	EKWA.58.5 or EKWA.58.5C	Repair Kit	EKWA.58.5 or EKWA.58.5C	Repair Kit	EKWA.58.5 or EKWA.58.5C	Repair Kit	EKWA.58.5 or EKWA.58.5C
27.01.5022		---		27.01.5120		27.01.5300	
							
Alternative Part No	9730090220	Alternative Part No	9730091000	Alternative Part No	9730091200	Alternative Part No	9730093000
M16 Ports		M16 Ports		M16 Ports		M16 & M22 Voss Ports C/W Silencer	
Repair Kit	EKWA.58.5 or EKWA.58.5C	Repair Kit	EKWA.58.5 or EKWA.58.5C	Repair Kit	EKWA.58.5 or EKWA.58.5C	Repair Kit	EKWA.58.5 or EKWA.58.5C

For Silencers please see pages 90.8 & 90.9

TRAILER CONTROL VALVES

EBS HALDEX KITS

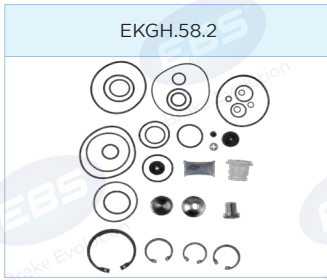

EBS KNORR BREMSE KITS

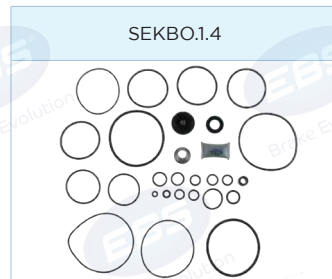
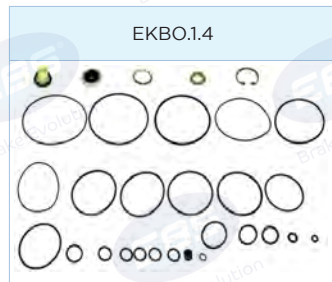

EBS WABCO KITS

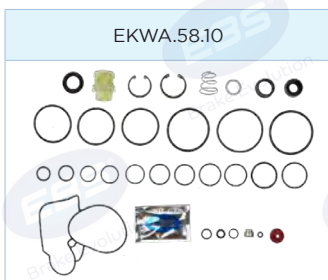
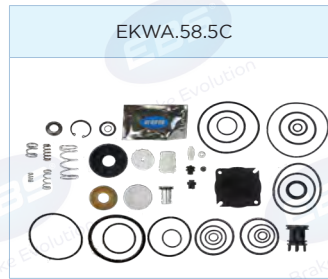
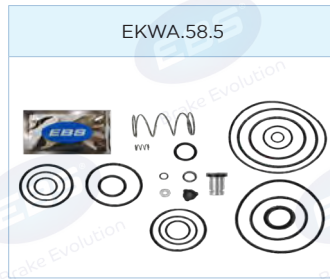
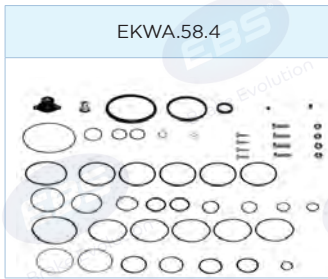
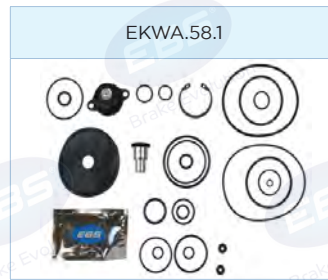
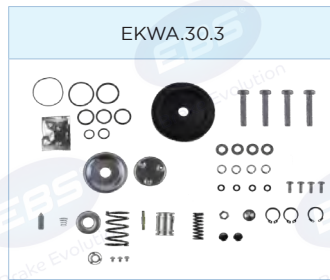

TRAILER CONTROL VALVES

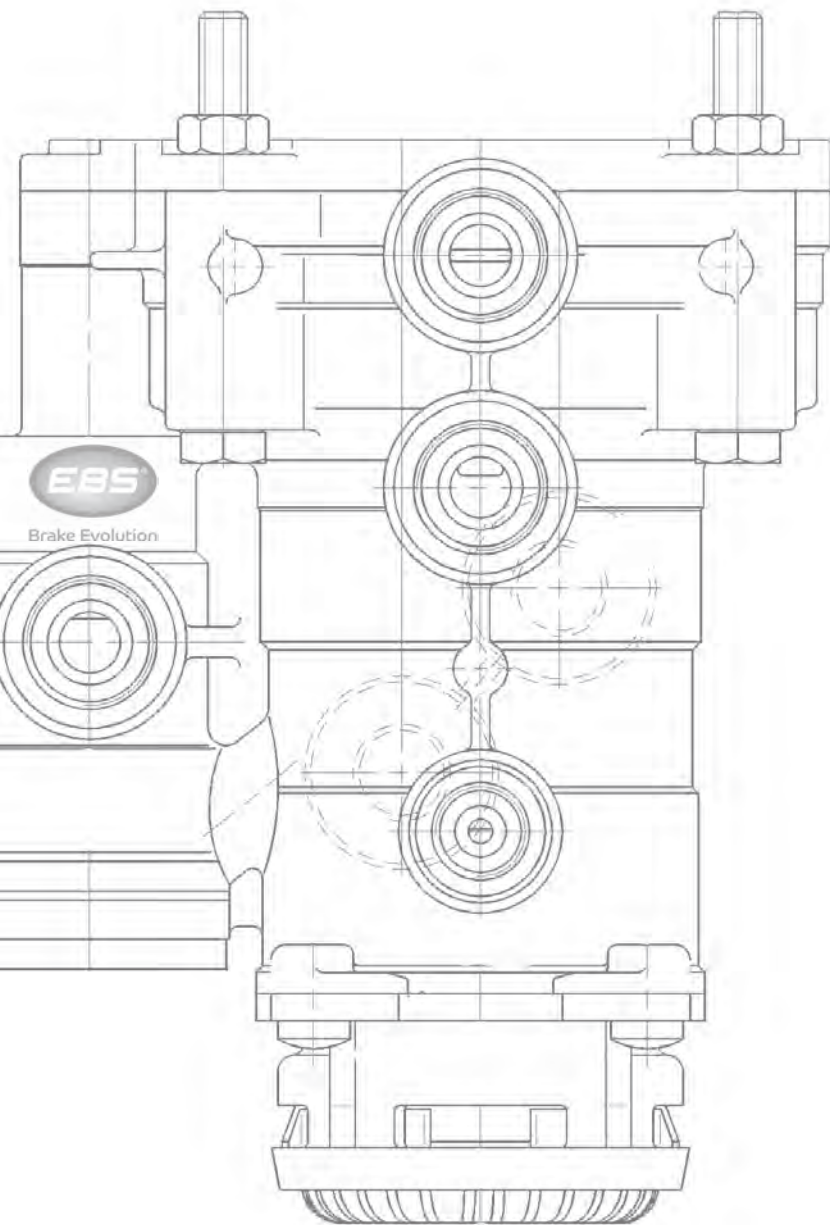

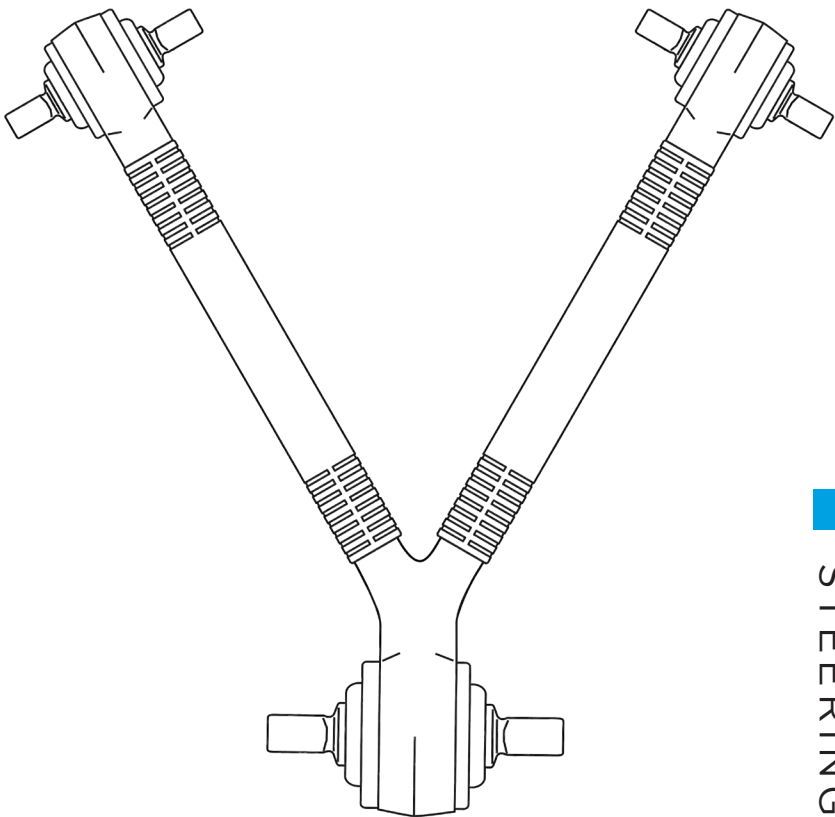
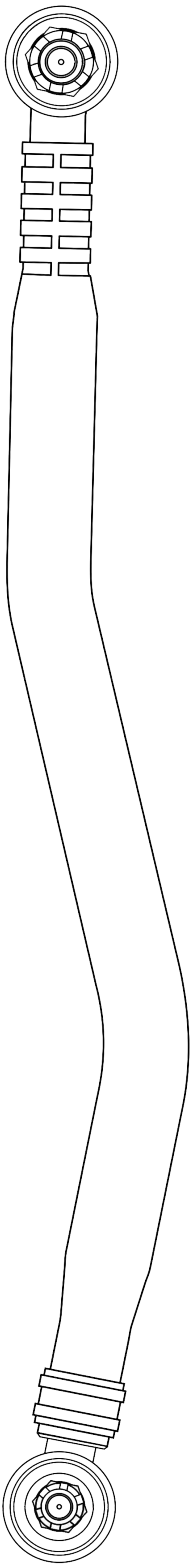
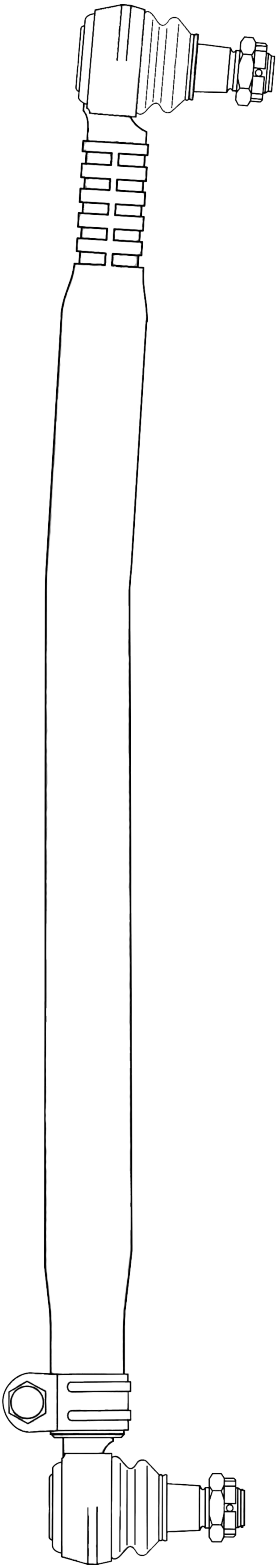







STEERING PRODUCTS

EBS DRAGLINKS

29.21.1001		29.21.1007		29.21.1008		29.21.1009	
							
Length = 1522 mm		Length = 1690 mm		Length = 1698 mm		Length = 1734 mm	
Application	DAF 1732980	Application	DAF 1700000	Application	DAF 1353391 1270853	Application	DAF 1337644 1270854
Lemforder Reference	37323	Lemforder Reference	33980	Lemforder Reference	20593	Lemforder Reference	21807
29.21.1019		29.21.1022		29.21.1024		29.21.1030	
							
Length = 860 mm		Length = 860 mm		Length = 867 mm		Length = 919 mm	
Application	DAF 1696072	Application	DAF 1451129 1380417	Application	DAF 1602821 1363859 1448063	Application	DAF 1407774
Lemforder Reference	37459	Lemforder Reference	26842	Lemforder Reference	26841	Lemforder Reference	34032
29.21.1037		29.21.1044		29.21.1045		29.21.1046	
							
Length = 1815 mm		Length = 900 mm		Length = 926 mm		Length = 991 mm	
Application	DAF 1451121 1433449	Application	DAF 1405655 1406025 1407144 1700912	Application	DAF 1405309 1403898	Application	DAF 11395994
Lemforder Reference	30998	Lemforder Reference	34034	Lemforder Reference	34026	Lemforder Reference	26826
29.21.1047		29.21.1060		29.21.1064		29.21.1065	
							
Length = 996 mm		1130 mm		865 mm		1698 mm	
Application	DAF OE: 1395993	Application	DAF 0094044 0274878 1152427	Application	DAF 1602820 1363858	Application	DAF 1448065 1373879
Lemforder Reference	26831	Lemforder Reference	19781	Lemforder Reference	30290	Lemforder Reference	34047

EBS DRAGLINKS

29.21.1066		29.21.1076		29.21.1077		29.21.1078	
							
1698 mm		930 mm		900 mm		1691 mm	
Application	DAF 1732973	Application	DAF 1405363	Application	DAF 1700913 1406600	Application	DAF 1408040
Lemforder Reference	37322	Lemforder Reference	34027	Lemforder Reference	34035	Lemforder Reference	---
29.21.1079		29.21.1087		29.21.1092		29.21.1116	
							
1734 mm		1215 mm		910 mm		876 mm	
Application	DAF 1700001	Application	DAF 1661183	Application	DAF 1401937	Application	DAF 1283211 1351714 1385497
Lemforder Reference	33981	Lemforder Reference	30999	Lemforder Reference	34025	Lemforder Reference	360113
29.25.1000		29.25.1002		29.25.1015		29.25.1026	
							
Length = 1477 mm		Length = 1570 mm		Length = 820 mm		Length = 888 mm	
Application	VECO 41032608 41033237	Application	IVECO 504034521	Application	IVECO 98467459 98402544	Application	IVECO 500311471 98491559
Lemforder Reference	27892	Lemforder Reference	30078	Lemforder Reference	19339	Lemforder Reference	22814
29.25.1028		29.25.1031		29.25.1034		29.25.1035	
							
Length = 892 mm		Length = 953 mm		Length = 1315 mm		Length = 1631 mm	
Application	IVECO 504049893	Application	IVECO 41042919 41005463 8131582 8132397	Application	IVECO 41296162	Application	IVECO 41042730 41005450 41005451 41036943 41036944 8163773
Lemforder Reference	33416	Lemforder Reference	19621	Lemforder Reference	35513	Lemforder Reference	21285

STEERING PRODUCTS

EBS DRAGLINKS

29.25.1058		29.25.1080		29.26.1005		29.26.1032	
1490 mm		1577 mm		Length = 1679 mm		Length = 993 mm	
Application	IVECO 500307556 98402553	Application	IVECO 41005460 41005309 8165309	Application	MAN OE: 81467116863 81467116773 81467116858 81467116859 81467116860 81467116861	Application	MAN 81466116136 81466106807 81466106808 81466116096 81466116097 81466116099
Lemforder Reference	21385	Lemforder Reference	25318	Lemforder Reference	25395	Lemforder Reference	30592
29.26.1032		29.26.1041		29.26.1050		29.26.1115	
Length = 993 mm		Length = 882 mm		1577 mm		840 mm	
Application	MAN 81466116132 81466116133 81466116136 81466116197 81466116198 81466116205	Application	MAN 85466106156	Application	MAN 81466106001 81466106725 85466106030 85466106102	Application	MAN 85466106021 85466105121 85466106140
Lemforder Reference	---	Lemforder Reference	28330	Lemforder Reference	19607	Lemforder Reference	360226
29.27.1003		29.27.1013		29.27.1017		29.27.1018	
Length = 1605 mm		Length = 733 mm		Length = 837 mm		Length = 846 mm	
Application	MERCEDES 9753300203 9753300303 9753300803 9753301703 9753302503	Application	MERCEDES 0014601505 34603305 14607305 3754601605	Application	MERCEDES 9724601505 9724601705	Application	MERCEDES 9704600805 9704601005
Lemforder Reference	23996	Lemforder Reference	29799	Lemforder Reference	24242	Lemforder Reference	24240
29.27.1053		29.27.1055		29.27.1025		29.27.1029	
Length = 495 mm		Length = 1594 mm		Length = 880 mm		Length = 894 mm	
Application	MERCEDES 6704602805 6704602905	Application	MERCEDES- 6703300203 6703300303	Application	MERCEDES 24604405 24604305 34604805	Application	MERCEDES OE: 9744601105 9744601305 34600705 34604705
Lemforder Reference	12934	Lemforder Reference	12877	Lemforder Reference	24243	Lemforder Reference	26024

EBS DRAGLINKS

29.27.1042		29.27.1043		29.27.1056		29.27.1057	
							
Length = 895 mm		Length = 895 mm		Length = 1596 mm		Length = 1612 mm	
Application	MERCEDES OE: 0024604505 24604605 34605005 3754600405	Application	MERCEDES 34605605 24605005 24604905	Application	MERCEDES 9493301003 9493301103 9493301703 9493302103	Application	MERCEDES 9723300003 9723300103
Lemforder Reference	25721	Lemforder Reference	25447	Lemforder Reference	23994	Lemforder Reference	23976
29.27.1068		29.27.1084		29.27.1088		29.28.1006	
							
Length = 504 mm		Length = 1095 mm		Length = 926 mm		Length = 1686 mm	
Application	MERCEDES 6674601605 6674601805	Application	MERCEDES 0014601305 0014601405 0024600505 0034603205 3754601505	Application	MERCEDES 3754602105 3754602305"	Application	RENAULT 21560963 5001868366 5010587034 5010587038 7421560963
Lemforder Reference	24581	Lemforder Reference	33576	Lemforder Reference	---	Lemforder Reference	37229
29.28.1016		29.28.1040		29.28.1062		29.28.1067	
							
Length = 825 mm		Length = 866 mm		Length = 552 mm		Length = 1758 mm	
Application	RENAULT 20777411 5001868389 5010647032 5010647033 7421560884 7421560889	Application	RENAULT 7421560950 7420847206	Application	RENAULT 7421021392 7482292080	Application	RENAULT 5010439021 5010566063
Lemforder Reference	33583	Lemforder Reference	35605	Lemforder Reference	35611	Lemforder Reference	29454
29.28.1070		29.28.1071		29.28.1074		29.28.1075	
							
Length = 891 mm		Length = 1669 mm		Length = 825 mm		Length = 1818 mm	
Application	RENAULT 5010557423	Application	RENAULT 20581086	Application	RENAULT 7421560901 5010630815 5001868386	Application	RENAULT 20399543 21299034 85115631
Lemforder Reference	29434	Lemforder Reference	34528	Lemforder Reference	36174	Lemforder Reference	37225

EBS DRAGLINKS

29.28.1082		29.28.1086		29.28.1089		29.28.1110	
Length = 720 mm		Length = 552 mm		Length = 940 mm		Length = 1650 mm	
Application	RENAULT 5010060764 5010557243	Application	RENAULT 7421021392 7482292080	Application	RENAULT 5010488166	Application	RENAULT 5010566157
Lemforder Reference	19857	Lemforder Reference	35611	Lemforder Reference	27953	Lemforder Reference	361089
29.28.1111		29.28.1112		29.28.1114		29.28.1117	
Length = 1719 mm		Length = 1726 mm		Length = 825 mm		Length = 900 mm	
Application	RENAULT 5001868404 5010587049 5010587052 7421560965 25370844	Application	RENAULT 5001868363 5010587004 5010600822 7421560957	Application	RENAULT 5001868384 5010630822 5010630823 7421560882 25379293	Application	RENAULT 5010488084 5010488639 5010488759 5010557341
Lemforder Reference	360872	Lemforder Reference	360689	Lemforder Reference	360669	Lemforder Reference	361010
29.29.1010				29.29.1011		29.29.1011	
Length = 1743 mm				Length = 1743 mm		Length = 1743 mm	
Application	SCANIA 1897333 1361413 1395614	Application	SCANIA 1734019 2040254 2146105	Application	SCANIA 2113903 1369411 1385251 1409918	Application	SCANIA 1501030 1723895 1737683 1897335
Lemforder Reference	37547			Lemforder Reference	22083	Lemforder Reference	22083
29.29.1033		29.29.1038		29.29.1051		29.29.1052	
Length = 1059 mm		Length = 1920 mm		Length = 438,5 mm		Length = 915 mm	
Application	SCANIA 1384027 1384027 1769597 1847312 1912758	Application	SCANIA 1732635 1343264	Application	SCANIA 1394884 1938387	Application	SCANIA 1304571 13045711 381339
Lemforder Reference	21009	Lemforder Reference	23493	Lemforder Reference	25139	Lemforder Reference	11927

EBS DRAGLINKS

29.29.1059	
	
Length = 435 mm	
Application	SCANIA 1343283 1759691
Lemforder Reference	21455

29.29.1069		
		
Length = 1743		
Application	SCANIA 1897336 1723896 1527978 1737684	SCANIA 1527989 2125091 2146104 2161884
Lemforder Reference	37546	

29.29.1072	
	
Length = 1256 mm	
Application	SCANIA 0481690 1897671
Lemforder Reference	21449

29.29.1073	
	
Length = 635 mm	
Application	SCANIA 1895862 1433532 1755506 0475460
Lemforder Reference	27558

29.29.1085	
	
Length = 1921 mm	
Application	SCANIA 2007279 1747467 1733471
Lemforder Reference	36655

29.29.1109	
	
Length = 1606 mm	
Application	SCANIA 1385764 1765376
Lemforder Reference	360924

29.30.1004	
	
Length = 1639 mm	
Application	VOLVO 85115641 20361568
Lemforder Reference	29614

29.30.1012	
	
Length = 2339 mm	
Application	VOLVO 20581633
Lemforder Reference	35948

29.30.1014	
	
Length = 770 mm	
Application	VOLVO OE: 9522701
Lemforder Reference	29814

29.30.1023	
	
Length = 863 mm	
Application	VOLVO 21106952 20375556 21106952
Lemforder Reference	28091

29.30.1027	
	
Length = 888 mm	
Application	VOLVO 85115621 20376808 85115621
Lemforder Reference	27631

29.30.1039	
	
Length = 1977 mm	
Application	DAF 1451122
Lemforder Reference	26036

29.30.1054	
	
Length = 1645 mm	
Application	VOLVO 1626637 1628637 3962343 39623434 3986450 3988711
Lemforder Reference	22822

29.30.1061	
	
Length = 1022 mm	
Application	VOLVO 8132373
Lemforder Reference	11971

29.30.1091	
	
Length = 1147 mm	
Application	VOLVO 70313773 9959244
Lemforder Reference	25551

STEERING PRODUCTS

EBS DRAGLINKS

29.30.1063	
Length = 908 mm	
Application	VOLVO 20376370 20386337 85115619
Lemforder Reference	34929

29.30.1081	
Length = 895 mm	
Application	VOLVO 21562336 21698606 22380817 22526507
Lemforder Reference	---

29.30.1083	
Length = 572 mm	
Application	VOLVO 1088985 20393083
Lemforder Reference	24382

29.30.1090	
Length = 824 mm	
Application	VOLVO 21106933 20375787
Lemforder Reference	26779

29.30.1108	
Length = 1028 mm	
Application	VOLVO 20490120 20745924 21308024 9519279
Lemforder Reference	360596

29.30.1113	
Length = 743 mm	
Application	VOLVO 20497799 3112273 9959152
Lemforder Reference	360678

29.43.1020	
Length = 860 mm	
Application	VDL 20312649
Lemforder Reference	37594

29.43.1021	
Length = 860 mm	
Application	VDL OE: 312648
Lemforder Reference	37593

EBS STABILIZERS

29.21.2003	
C:27/30 L:2028 mm	
Application	DAF OE: 1801332
Lemforder Reference	33983

29.26.2001	
C:23,5/26 L:160 mm LEFT	
Application	SCANIA OE: 486590
Lemforder Reference	27648

29.28.2011	
Length = 325 mm	
Application	RENAULT 7421446333
Lemforder Reference	620056

29.29.2005	
C:23,5/26 L:130 mm	
Application	SCANIA 1766015 445626
Lemforder Reference	21806

29.30.2002	
C:23,9/28,6 L:367 mm (LEFT)	
Application	VOLVO 9523163 70314305 70397006
Lemforder Reference	30986

29.30.2003	
C:27,3/31,7 L:150 mm	
Application	VOLVO OE: 9959503
Lemforder Reference	31309

29.30.2004	
C:23,9/28,6 L:367 mm RIGHT	
Application	VOLVO 70397005 70314307 9959462
Lemforder Reference	29815

EBS TIE ROD ENDS

29.42.3003		29.21.3004		29.21.3005		29.25.3001		29.27.3002	
									
M30x1.5 LHT C:27.1/30 L:125 mm (M)		M30x1.5 RHT C:27.1/30 L:141 mm (M)		M30x1.5 RHT C:34.3/38 L:86 mm (F)		M26x1.5 RHT C:27.1/30 L:75 mm (F)		M26x1.5 RHT C:28.8/32 L:75 mm (F)	
Application	BMC 1228115 9P914835	Application	DAF 2115316	Application	DAF 3099129	Application	IVECO 42533073	Application	MERCEDES 5001845430 24600648 14601548 14601648
Lemforder Reference	11492	Lemforder Reference	25353	Lemforder Reference	25073	Lemforder Reference	33772	Lemforder Reference	33397

EBS TORQUE RODS

29.21.4002		29.21.4004		29.26.4001			
							
Length = 600 mm		Length = 606 mm		Length = 571 mm			
Application	DAF OE: 1274741	Application	DAF 1294251	Application	MAN 81432206129 81432206096 81432206097		
Lemforder Reference	26823	Lemforder Reference	22904	Lemforder Reference	11757		
29.29.4003		29.29.4005		29.29.4006		29.29.4007	
							
Length = 616,5 mm		Length = 522 mm		Length = 592 mm		Length = 599 mm	
Application	SCANIA 1399019 1500576	Application	SCANIA 1486758	Application	SCANIA 1388436 1722748 1499476	Application	SCANIA 20762454 20762545 20816718
Lemforder Reference	27582	Lemforder Reference	28969	Lemforder Reference	30969	Lemforder Reference	31959
29.30.4011		29.29.4012					
							
Length = 510mm		Length = 570 mm					
Application	VOLVO 9955949 24426046	Application	SCANIA 1486756				
Lemforder Reference	720322	Lemforder Reference	720102				

STEERING PRODUCTS

EBS V STAY BARS

29.21.5001		29.21.5009		29.25.5007	
Length = 608.2 mm		609 mm		Length = 665 mm	
Application	DAF OE: 1793876	Application	DAF 0080521 1361651 1368270 1390932	Application	MAN 08137026 41002770 41009665 41028598 41028600 41034479 41042050 8137026
Lemforder Reference	25043	Lemforder Reference	26691	Lemforder Reference	11715

29.26.5005		29.26.5006		29.27.5002		29.27.5003	
Length = 693.5 mm		Length = 627 mm		Length = 622 mm		Length = 622 mm	
Application	MAN OE: 1342709053 81432706053	Application	MAN OE: 81432206221 81432706096 81432706114 81432706163	Application	MERCEDES- BENZ OE: 9423501505 9423501005 9443500005 9473500105	Application	MERCEDES-BENZ OE: 9483503005 3753500205 9443500305 9443500505 9443500605 9473500705 9473500905 9483500405 9483501105
Lemforder Reference	20399	Lemforder Reference	25210	Lemforder Reference	21168	Lemforder Reference	23069

29.27.5008		29.28.5004	
Length = 622 mm		Length = 663 mm	
Application	MERCEDES- BENZ 3753500505 9423501205 9603500105 9423500505 9423500805	Application	RENAULT 20507262 7420741703
Lemforder Reference	31887	Lemforder Reference	26058

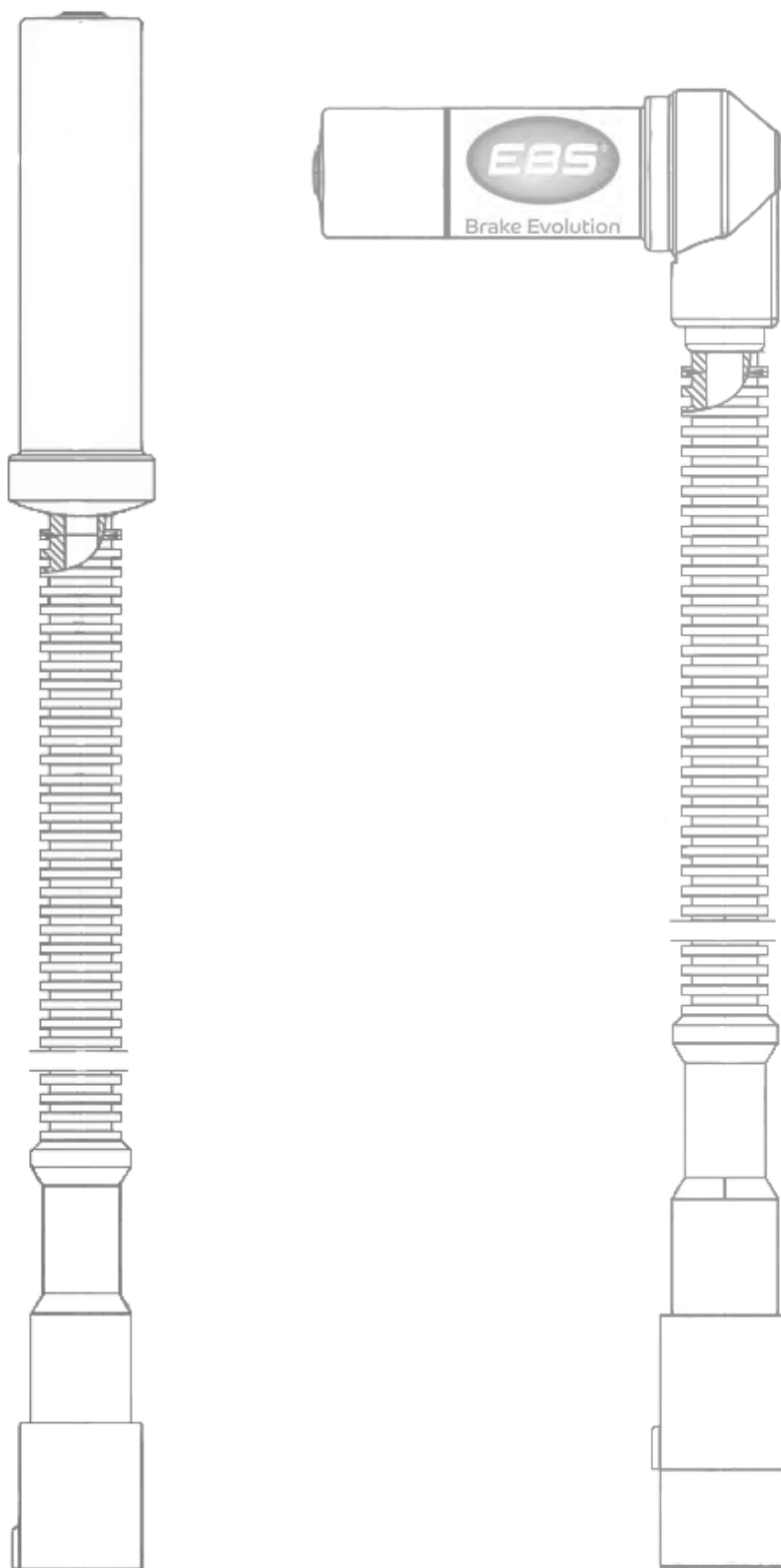

FOR *BRAKE PAD WEAR SENSORS* - See Page 3A.6

FOR *EXCITER RINGS* - See Section 31

ABS SENSORS - BOSCH

EBS Part No	Alternative	Information	Image	
30.01.1012	0486000129000 0486000135000	Length = 2.05M Angled		
30.01.1029	0265050128	Length = 3.55M Angled		
30.01.1048	0265050143	Length = 2.68M Angled Armour Coated Cable		
30.04.1008	0486001033	Length = 1.0M Straight		
30.04.1009	0265050110	Length = 1.40M Angled Armour Coated Cable & Grommet Seal		
30.04.1010	0265050109	Length = 1.40M Angled Armour Coated Cable & Grommet Seal		
30.04.1014	0486000052 0486200241	Length = 2.00M Angled Armour Coated Cable & Grommet Seal		
30.04.1015	0486000053 0486000242	Length = 2.00M Angled Armour Coated Cable & Grommet Seal		
30.04.1016	0486000045 0486000238 0486000238N00	Length = 2.00M Angled Armour Coated Cable & Grommet Seal		
30.04.1017	0486000051 0486000240 0486000241	Length = 2.00M Angled Armour Coated Cable & Grommet Seal		

ABS SENSORS - BOSCH					
EBS Part No	Alternative	Information	Image		
30.04.1018	0265050112	Length = 1.80M Angled			
30.04.1019	0486000132100	Length = 2.55M Angled			
30.04.1021	0265050150 0486000128 0486000136	Length = 1.00M Angled			
30.04.1022	0486000120	Length = 2.50M Angled			
30.04.1023	0486000121	Length = 2.50M Angled			
30.04.1024	0486000102	Length = 2.50M Angled			
30.04.1025	0486000101	Length = 2.00M Angled			
30.04.1026	0486000100	Length = 0.50M Angled			
30.04.1027	0486002005	Length = 0.50M Angled			
30.04.1029	0486000258	Length = 2.80M Angled Armour Coated Cable & Grommet Seal			

SENSORS & ASSOCIATED PRODUCTS

ABS SENSORS - BOSCH

EBS Part No	Alternative	Information	Image		
30.04.1030	0486000259	Length = 2.80M Angled Armour Coated Cable & Grommet Seal			
30.04.1031	0486000260	Length = 1.80M Angled Armour Coated Cable & Grommet Seal			
30.04.1032	0486000261	Length = 1.80M Angled Armour Coated Cable & Grommet Seal			
30.04.1033	0486002001	Length = 2.60M Angled Armour Coated Cable & Grommet Seal			
30.04.1034	0486002002	Length = 2.60M Angled Armour Coated Cable & Grommet Seal			
30.04.1035A/B	0486002003 0486002004	Length = 2.35M Angled Armour Coated Cable 1 x Insert "A" & 1 x Insert "B"			
30.04.1036	0486000103	Length = 2.50M Angled Armour Coated Cable			
30.04.1037	0486000104	Length = 2.50M Angled Armour Coated Cable			
30.04.1040 Opposite Side: 30.04.1048	0486000239 0486000239N00	Length = 1.30M Angled Armour Coated Cable & Grommet Seal			
30.04.1041	0486000262000 0486000262N00	Length = 3.90M Angled Armour Coated Cable & Grommet Seal			

ABS SENSORS - BOSCH

EBS Part No	Alternative	Information	Image		
30.04.1042	0486000263000 0486000263N00	Length = 3.90M Angled Armour Coated Cable & Grommet Seal			
30.04.1043	0486000276N00	Length = 1.10M Angled Armour Coated Cable & Grommet Seal			
30.04.1044	0486000277N00	Length = 1.10M Angled Armour Coated Cable & Grommet Seal			
30.04.1045	0486000257	Length = 2.15M Angled Armour Coated Cable & Grommet Seal			
30.04.1046	0486000256	Length = 1.50M Angled Armour Coated Cable & Grommet Seal			
30.04.1047	0486000107	Length = 1M Angled Grommet Seal			
30.04.1048 Opposite Side: 30.04.1040	0486000237	Length = 1.30M Angled Armour Coated Cable & Grommet Seal			
30.04.1053A/B	0486000071000 0486000000000	Length = 2.4M Angled			
30.04.1054	0486000105	Length = 1.45M Angled			
30.04.1057	0486000284	Length = 1M Angled			

SENSORS & ASSOCIATED PRODUCTS

ABS SENSORS - BPW

EBS Part No	Alternative	Information	Image		
30.01.1002	0233170700	Length = 0.40M Straight			
30.03.1002	0233170700	Length = 0.40M Straight Grommet Seal As 30.01.1002 But Cable Dia is 6.2mm			
30.01.1003	0233170500	Length = 0.40M Angled			
30.03.1001	0233170500	Length = 0.40M Angled Grommet Seal As 30.01.1003 But Cable Dia is 6.2mm			
30.01.1029	0233170100	Length = 3.55M Angled			

ABS SENSORS - DAF

EBS Part No	Alternative	Information	Image		
30.01.1000	1505211	Length = 1.00M Straight			
30.01.1001	1504929	Length = 1.00M Angled			
30.01.1002	1506004	Length = 0.40M Straight			

ABS SENSORS - DAF					
EBS Part No	Alternative	Information			Image
30.03.1002	1506004	Length = 0.40M Straight Grommet Seal As 30.01.1002 But Cable Dia is 6.2mm			
30.01.1004	1400071	Length = 1.70M Straight			
30.01.1006	1405826	Length = 1.70M Angled			
30.01.1008	1407692 1505215	Length = 2.00M Angled			
30.01.1010	1518008	Length = 2.00M Angled Armour Coated Cable			
30.01.1013	1506003	Length = 1.00M Angled Armour Coated Cable			
30.01.1014	1518009	Length = 2.50M Straight Armour Coated Cable			
30.01.1016	1505212	Length = 2.08M Angled			
30.01.1029	1518010	Length = 3.55M Angled			

SENSORS & ASSOCIATED PRODUCTS

ABS SENSORS - DAF

EBS Part No	Alternative	Information	Image		
30.01.1035	1517455	Length = 2.00M Angled			
30.01.1041	1518007	Length = 2.00M Angled Mounting Bracket & Guide Pipes			
30.01.1042	1524830	Length = 2.00M Angled			
30.01.1044	1315691 1361393 1778554	Length = 0.25M Angled			
30.01.1058	1505214	Length = 2.05M Angled			
30.01.1100	1518002 1518003	Length = 2.9M Angled			
30.01.3144	1862600	Length = 1.5M Angled			
30.01.3145	1869290	Length = 1.4M Angled			

ABS SENSORS - DENNIS

EBS Part No	Alternative	Information	Image	
30.01.1081	65730431 65868530	Length = 0.50M Straight		
30.04.1021	657082-7	Length = 1.00M Angled		

ABS SENSORS - EVOBUS

EBS Part No	Alternative	Information	Image	
30.01.1081	89199302874	Length = 0.50M Straight		
30.01.1094	A0005422418	Length = 1.94M Angled		
30.04.1024	7788090000	Length = 2.50M Angled		

ABS SENSORS - FRUEHAUF

EBS Part No	Alternative	Information	Image	
30.01.1003	CF102959	Length = 0.40M Angled		
30.03.1001	CF102959	Length = 0.40M Angled Grommet Seal As 30.01.1003 But Cable Dia is 6.2mm		

SENSORS & ASSOCIATED PRODUCTS

ABS SENSORS - HALDEX

EBS Part No	Alternative	Information	Image	
30.01.1002	950364506	Length = 0.40M Straight		
30.01.1003	950364503	Length = 0.40M Angled		
30.03.1001	950364503	Length = 0.40M Angled As 30.01.1003 But Cable Dia is 6.2mm		
30.03.1002	950364506	Length = 0.40M Straight As 30.01.1002 But Cable Dia is 6.2mm		
---	950364501	Length = 2.40M Straight ABS GX DGX MGX2 MGX2E		
---	950364502	Length = 2.60M Angled ABS GX DGX MGX		



ABS SENSORS - IVECO					
EBS Part No	Alternative	Information			Image
30.01.1001	4460000009	Length = 1.00M Angled			
30.01.1003	5801115879 9441032808	Length = 0.40M Angled			
30.03.1001	5801115879 9441032808	Length = 0.40M Angled As 30.01.1003 But Cable Dia is 6.2mm			
30.01.1004	504013848	Length = 1.70M Straight			
30.01.1005	41200584	Length = 2.50M Angled			
30.01.1008	5006010272	Length = 2.00M Angled			
30.01.1012	41200561	Length = 2.05M Angled			
30.01.1029	42061638	Length = 3.55M Angled			
30.01.1042	41200611	Length = 2.50M Angled			
30.01.1058	89419513 98419513	Length = 2.05M Angled			

ABS SENSORS - IVECO

EBS Part No	Alternative	Information	Image	
30.01.1061	41221280	Length = 2.05M Straight		
30.01.2590	5006015612	Length = 2.00M Angled Armour Coated		
30.04.1028	500342090 504007426	Length = 1.30M Angled		
30.04.1056	0486000183	Length = 2M Angled		

ABS SENSORS - KASSBOHRER

EBS Part No	Alternative	Information	Image	
30.01.1001	77880750340	Length = 1.00M Angled		

ABS SENSORS - KNORR BREMSE

EBS Part No	Alternative	Information	Image	
30.01.1003	ES5020	Length = 0.40M Angled		
30.03.1001	ES5020	Length = 0.40M Angled As 30.01.1003 But Cable Dia is 6.2mm		
30.01.1107	265050103	Length = 0.44M Angled		
30.01.1108	265050102	Length = 0.44M Angled		

ABS SENSORS - MAN					
EBS Part No	Alternative	Information	Image		
30.01.1008	81271206117	Length = 2.00M Angled			
30.01.1033	36271206004	Length = 3.00M Straight			
30.01.1015	36271206005	Length = 3.00M Straight			
30.01.1062	81271206105 81271206218	Length = 3.00M Straight Armour Coated Cable			
30.01.1063	81271206106 81271206219	Length = 3.00M Straight Armour Coated Cable & Grommet Seal			
30.01.1070	4410323430	Length = 3.00M Straight Armour Coated Cable			
30.01.1071	4410323440	Length = 3.00M Straight Armour Coated Cable			
30.01.1088	81271206190	Length = 2.00M Angled Armour Coated Cable & Grommet Seal			
30.01.1089	81271206191	Length = 2.00M Angled Armour Coated Cable & Grommet Seal			

SENSORS & ASSOCIATED PRODUCTS

ABS SENSORS - MAN

EBS Part No	Alternative	Information	Image	
30.01.2560	4410322560	Length = 2.60M Angled Armour Coated Cable		
30.01.2630	4410322630 81271206122 81511016485	Length = 2.07M Angled Armour Coated Cable		
30.01.2640	4410322640	Length = 2.07M Angled Armour Coated Cable		
30.01.2650	81271206121	Length = 2.60M Angled Armour Coated Cable		
30.01.2660	81271206122 81511016485	Length = 2.60M Angled Armour Coated Cable		
30.01.2680	4410322680 81271206193	Length = 3.05M Angled		
30.01.2690	4410322690 81271206194	Length = 2.35 M Angled		
30.01.2880	81271206186	Length = 2.07M Straight Armour Coated Cable		
30.01.2890	81271206187	Length = 2.07M Straight Armour Coated Cable		

ABS SENSORS - MAN					
EBS Part No	Alternative	Information	Image		
30.01.2900	81271206188	Length = 2.60M Straight Armour Coated Cable			
30.01.2910	81271206189	Length = 2.60M Straight Armour Coated Cable			
30.01.2920	81271206192	Length = 3.00M Straight Armour Coated Cable			
30.01.2930	81271206203	Length = 2.80M Straight Armour Coated Cable			
30.01.2940	81271206204	Length = 3.30M Straight Armour Coated Cable			
30.01.2960	81271206119 81271206182	Length = 2.07M Straight Armour Coated Cable			
30.01.2970	81271206120 81271206183	Length = 2.07M Straight Armour Coated Cable			
30.01.2980	81271206184	Length = 2.60M Straight Armour Coated Cable			
30.01.2990	81271206185	Length = 2.60M Straight Armour Coated Cable			

SENSORS & ASSOCIATED PRODUCTS

ABS SENSORS - MAN

EBS Part No	Alternative	Information	Image		
30.01.3107	81271206174 81271206179 81271206200 81271206220	Length = 1.30M Angled Armour Coated Cable			
30.01.3108	81271206178 81271206221	Length = 1.30M Angled Armour Coated Cable			
30.01.3111	81271206224	Length = 2.30M Angled Armour Coated Cable & Grommet Seal			
30.01.3112	81271206225	Length = 2.30M Angled Armour Coated Cable & Grommet Seal			
30.01.3115	81271206228	Length = 3.00M Angled Armour Coated Cable & Grommet Seal			
30.01.3116	81271206229	Length = 3.50M Angled Armour Coated Cable & Grommet Seal			
30.04.1004	81271206147	Length = 2.00M Straight Armour Coated Cable			
30.04.1005	81271206146	Length = 2.00M Straight Armour Coated Cable			
30.04.1014	81271206007 81271206017 81271206045 81271206067 81271206156 81271296039	Length = 2.00M Angled Armour Coated Cable & Grommet Seal			

ABS SENSORS - MAN

EBS Part No	Alternative	Information	Image		
30.04.1015	81271206006 81271206018 81271206040 81271206046 81271206068 81271206157	Length = 2.00M Angled Armour Coated Cable & Grommet Seal			
30.04.1016	81271206077 81271206149	Length = 2.00M Angled Armour Coated Cable & Grommet Seal			
30.04.1017	81271206151	Length = 2.00M Angled Armour Coated Cable & Grommet Seal			
30.04.1029	81271206123 81271206171	Length = 2.80M Angled Armour Coated Cable & Grommet Seal			
30.04.1030	81271206124 81271206170	Length = 2.80M Angled Armour Coated Cable & Grommet Seal			
30.04.1031	81271206125 81271206169	Length = 1.80M Angled Armour Coated Cable & Grommet Seal			
30.04.1032	81271206126 81271206168	Length = 1.80M Angled Armour Coated Cable & Grommet Seal			
30.04.1033	0486002001000	Length = 2.60M Angled Armour Coated Cable & Grommet Seal			
30.04.1034	0486002002000	Length = 2.60M Angled Armour Coated Cable & Grommet Seal			

SENSORS & ASSOCIATED PRODUCTS

ABS SENSORS - MAN

EBS Part No	Alternative	Information	Image		
30.04.1036	0486000103000	Length = 2.50M Angled Armour Coated Cable			
30.04.1037	0486000104000	Length = 2.50M Angled Armour Coated Cable			
30.04.1038	81271206097 81271206131 81271206177	Length = 1.50M Angled Armour Coated Cable & Grommet Seal			
30.04.1039	81271206176	Length = 1.50M Angled Armour Coated Cable			
30.04.1040	81271206072 81271206154	Length = 1.30M Angled Armour Coated Cable & Grommet Seal			
30.04.1041	81271206167	Length = 3.90M Angled Armour Coated Cable & Grommet Seal			
30.04.1042	81271206166	Length = 3.90M Angled Armour Coated Cable & Grommet Seal			
30.04.1043	81271206201	Length = 1.10M Angled Armour Coated Cable & Grommet Seal			
30.04.1044	81271206202	Length = 1.10M Angled Armour Coated Cable & Grommet Seal			

ABS SENSORS - MAN					
EBS Part No	Alternative	Information	Image		
30.04.1045	81271206164	Length = 1.50M Angled Armour Coated Cable & Grommet Seal			
30.04.1046	81271206165	Length = 1.50M Angled Armour Coated Cable & Grommet Seal			
30.04.1048	81271206073	Length = 1.30M Angled Armour Coated Cable & Grommet Seal			
30.04.1051	81271206160	Length = 3.555M Angled			
30.04.1052	81.27120.6161	Length = 3.555M Angled			
30.01.1117	81.27120.6175	Length = 1.85 M Angled			

SENSORS & ASSOCIATED PRODUCTS

ABS SENSORS - MERCEDES

EBS Part No	Alternative	Information	Image	
30.01.1004	A0065427618	Length = 1.70M Straight		
30.01.1007	3655400617	Length = 1.44M Straight Armour Coated Cable		
30.01.1009	0015427818	Length = 1.26M Angled Armour Coated Cable		
30.01.1010	0015420518 0015423418 0015428718	Length = 2.00M Angled Armour Coated Cable		
30.01.1011	0025422518	Length = 1.50M Angled Armour Coated Cable		
30.01.1014	A0025422718 A0025423005 A0025423818	Length = 2.50M Straight Armour Coated Cable		
30.01.1015	0015428818 0005423318 0015423318 0015428418 A0024522618	Length = 3.00M Straight Armour Coated Cable		
30.01.1029	6205420217 6205420517	Length = 3.55M Angled		
30.01.1031	0015426818 0025426818	Length = 1.35M Angled Armour Coated Cable		
30.01.1032	0025420518	Length = 0.08M Angled		

ABS SENSORS - MERCEDES			
EBS Part No	Alternative	Information	Image
30.01.1033	0005429718	Length = 3.00M Straight	
30.01.1035	0005429618	Length = 2.00M Angled	
30.01.1036	6255420018	Length = 3.00M Angled Armour Coated Cable	
30.01.1037	0035423518 0035424618	Length = 4.00M Straight	
30.01.1043	0005403417	Length = 1.50M Angled	



SENSORS & ASSOCIATED PRODUCTS

ABS SENSORS - MERCEDES

EBS Part No	Alternative	Information	Image		
30.01.1099	3575400917	Length = 1.43M Angled			
30.04.1025	A0135427917	Length = 2.00M Angled			
30.10.0005	0011530220 0011533872 0011539620	Length = 1.54M Angled			
30.10.0006	0011530420	Length = 1.56M Angled			
30.27.0001	0001539520 0011531620 0011531820 0011532020 0011561420	Length = 0.26M Angled			
30.01.1107	6505400217 6555400817	Length = 0.44M ABS SENSOR Angled			
30.01.1108	6505400117 6555400717	Length = 0.44M ABS SENSOR Angled			
30.01.1110	3575400317 3575400417 4410326230 4410326240	Length = 2.9M ABS SENSOR Angled			
30.01.1114	4410323960	Length = 1.3M ABS SENSOR			
30.01.1115	4410323970	Length = 1.45M ABS SENSOR			

ABS SENSORS - OPTARE					
EBS Part No	Alternative	Information	Image		
30.01.1004	24060006	Length = 1.70M Straight			
30.04.1021	24240031	Length = 1.00M Angled			

ABS SENSORS - RENAULT					
EBS Part No	Alternative	Information	Image		
30.01.1001	5010422332 5021170123	Length = 1.00M Angled			
30.01.1003	5010604322 5021170122	Length = 0.40M Angled			
30.03.1001	5010604322 5021170122	Length = 0.40M Angled As 30.01.1003 But Cable Dia is 6.2mm			
30.01.1008	5010422334	Length = 2.00M Angled			
30.01.1017	5010457732	Length = 0.85M Angled			
30.01.1018A/B	7420916175 7421363496	Length = 2.00M Straight 1 x Insert "A" & 1 x Insert "B"			

SENSORS & ASSOCIATED PRODUCTS

ABS SENSORS - RENAULT

EBS Part No	Alternative	Information	Image	
30.01.1020	5010457045	Length = 1.40M Angled		
30.01.1022A/B	5010457874	Length = 1.80M Straight Armour Coated Cable 1 x Insert "A" & 1 x Insert "B"		
30.01.1026A/B	7420915970 7420915973	Length = 4.30M Straight Grommet Seal 1 x Insert "A" & 1 x Insert "B"		
30.01.1027A/B	7424427344	Length = 4.00M Straight 1 x Insert "A" & 1 x Insert "B"		
30.01.1027C/D	7420528661	Length = 3.80M Straight Grommet Seal 1 x Insert "C" & 1 x Insert "D"		
30.01.1029	5000790125	Length = 3.55M Angled		
30.01.1057A/B	7420794630 7420916178	Length = 3.40M Straight Armour Coated Cable 1 x Insert "A" & 1 x Insert "B"		
30.01.1068	5010143018 5010143020 5010344160	Length = 0.93M Angled		
30.01.1069	5010143017 5010143019 5010344161	Length = 0.93M Angled		

ABS SENSORS - RENAULT

EBS Part No	Alternative	Information	Image		
30.01.1082A/B	7420785816 7420787816	Length = 2.00M Angled Armour Coated Cable 1 x Insert "A" & 1 x Insert "B"			
30.01.1083A/B	5010457883 7421363479	Length = 2.50M Angled Grommet Seal 1 x Insert "A" & 1 x Insert "B"			
30.01.1084A/B	5010457878 7421360516 7421364022	Length = 4.00M Angled Grommet Seal 1 x Insert "A" & 1 x Insert "B"			
30.01.1085A/B	5010457881 5010457892	Length = 5.50M Angled Grommet Seal 1 x Insert "A" & 1 x Insert "B"			
30.01.1093A/B	5010457871 5010457876 7420916171 7420916173	Length = 5.55M Straight 1 x Insert "A" & 1 x Insert "B"			
30.04.1009	5010143030	Length = 1.40M Angled Armour Coated Cable & Grommet Seal			
30.04.1010	5010143029	Length = 1.40M Angled Armour Coated Cable & Grommet Seal			
30.04.1049	5010344188	Length = 1.39M Angled Armour Coated Cable			
30.04.1050	5010344187	Length = 1.39M Angled Armour Coated Cable			

SENSORS & ASSOCIATED PRODUCTS

ABS SENSORS - SAF

EBS Part No	Alternative	Information	Image		
30.01.1001	4029104200	Length = 1.00M Angled			
30.01.1013	4029106400	Length = 1.00M Angled Armour Coated Cable			
30.01.3001	4029107100	Length = 0.40M Straight			

ABS SENSORS - SCANIA

EBS Part No	Alternative	Application	Image		
30.01.1003	1784588	Length = 0.40M Angled			
30.03.1001	1784588	Length = 0.40M Angled As 30.01.1003 But Cable Dia is 6.2mm			
30.01.1018A/B	1531361	Length = 2.00M Straight 1 x Insert "A" & 1 x Insert "B"			
30.01.1021	1342971 1428450 1530696 1534527	Length = 1.50M Angled Armour Coated Cable			
30.01.1022A/B	1482006 1482007 1530704 1531360 1729798 1729800 1892003 1892057	Length = 1.80M Straight Armour Coated Cable 1 x Insert "A" & 1 x Insert "B"			

ABS SENSORS - SCANIA					
EBS Part No	Alternative	Application			Image
30.01.1023	1431120 1530700 1534519	Length = 1.15M Straight Armour Coated Cable			
30.01.1024A/B	1428453 1428455 1530703 1534520 1534521 1547687 1892068 1892070	Length = 2.80M Angled Armour Coated Cable 1 x Insert "A" & 1 x Insert "B"			
30.01.1025A/B	1428451 1530705 1534522 1729792 1729793 1729794 1765294 1892063 1892064	Length = 2.68M Straight Armour Coated Cable 1 x Insert "A" & 1 x Insert "B"			
30.01.1026A/B	21247157	Length = 4.30M Straight Grommet Seal 1 x Insert "A" & 1 x Insert "B"			
30.01.1030A/B	1534525	Length = 2.65M Straight Grommet Seal 1 x Insert "A" & 1 x Insert "B"			
30.01.1045	1428446 1530090 1530690 1892047	Length = 1.00M Angled Armour Coated Cable			
30.01.1046	1114847 1530691	Length = 1.00M Angled			
30.01.1047	1478402	Length = 1.43M Angled Armour Coated Cable			
30.01.1048	1365526 1428447 1438888 1441274 1530692 1892028 1892048	Length = 2.68M Angled Armour Coated Cable			

SENSORS & ASSOCIATED PRODUCTS

ABS SENSORS - SCANIA

EBS Part No	Alternative	Application			Image
30.01.1049	1431119 1530693 1892049	Length = 1.43M Straight Armour Coated Cable			
30.01.1050	1441273 1453598 1530694 1892050	Length = 2.67M Straight Armour Coated Cable			
30.01.1051	1428442 1530695 1546365	Length = 1.15M Angled Armour Coated Cable			
30.01.1052	1441275 1530697 1892052	Length = 2.15M Straight Armour Coated Cable			
30.01.1053	1530698	Length = 2.24M Angled Armour Coated Cable & Grommet Seal			
30.01.1054	1353493 1355747 1365529 1428443 1438889 1530699 1892053	Length = 2.68M Angled Armour Coated Cable			
30.01.1055	1441276 1453597 1530701	Length = 2.67M Straight Armour Coated Cable			
30.01.1056A/B	1428454 1439666 1530702 1534528 1545506 1892056	Length = 2.00M Angled Armour Coated Cable 1 x Insert "A" & 1 x Insert "B"			
30.01.1057A/B	1437931 1437932 1530706 1765295 1787183 1892059	Length = 3.40M Straight Armour Coated Cable 1 x Insert "A" & 1 x Insert "B"			

ABS SENSORS - SCANIA					
EBS Part No	Alternative	Application			Image
30.01.1059C/D	1428451 1428452 1438785 1438786 1534522 1534525 1892058 530705	Length = 2.68M Straight Armour Coated Cable 1 x Insert "C" & 1 x Insert "D"			
30.01.1072	1890167 1890168	Length = 2.60M Angled			
30.01.1075	1890169	Length = 4.20M Angled			
30.01.1076	1890170 1890171	Length = 2.60M Straight			
30.01.1077	1089172	Length = 4.20M Straight			
30.01.1078	1400674 1441277 1530709	Length = 2.15M Angled Armour Coated Cable			
30.01.1079	1441278 1530710	Length = 2.15M Straight Armour Coated Cable			
30.04.1018	1350462 1356604	Length = 1.80M Angled			
30.04.1035A/B	1874641 1874642	Length = 2.35M Angled Armour Coated Cable 1 x Insert "A" & 1 x Insert "B"			

SENSORS & ASSOCIATED PRODUCTS

ABS SENSORS - SCANIA

EBS Part No	Alternative	Application			Image
30.01.1106	1534518 1892054	Length = 1.425M Straight			
30.01.1109A/B	1892072	Length = 4.2M Angled			
30.01.1111A/B	1892065	Length = 4.3M Straight			
30.04.1054	483548 0486000105	Length = 1.45M Angled			

CABLE HARNESS - SCANIA

EBS Part No	Alternative	Information			Image
30.11.3000	1729587	SCANIA CABLE HARNESS			

ABS SENSORS - SCHMITZ

EBS Part No	Alternative	Information			Image
30.01.1003	50019	Length = 0.40M Angled			
30.03.1001	50019	Length = 0.40M Angled As 30.01.1003 But Cable Dia is 6.2mm			

ABS SENSORS - SETRA					
EBS Part No	Alternative	Information	Image		
30.01.1003	778807500	Length = 0.40M Angled			
30.03.1001	778807500	Length = 0.40M Angled As 30.01.1003 But Cable Dia is 6.2mm			

ABS SENSORS - VOLVO					
EBS Part No	Alternative	Application	Image		
30.01.1004	20390737 21361902	Length = 1.70M Straight			
30.01.1006	20566832	Length = 1.70M Angled			
30.01.1018A/B	21363496	Length = 2.00M Straight 1 x Insert "A" & 1 x Insert "B"			
30.01.1026A/B	20509869 20554956 20554957 21247157 21247161	Length = 4.30M Straight Grommet Seal 1 x Insert "A" & 1 x Insert "B"			
30.01.1027A/B	20509864 20528661 21361900	Length = 4.00M Straight 1 x Insert "A" & 1 x Insert "B"			
30.01.1027C/D	20528662 20554951 20554952 21361890	Length = 3.80M Straight Grommet Seal 1 x Insert "C" & 1 x Insert "D"			

SENSORS & ASSOCIATED PRODUCTS

ABS SENSORS - VOLVO

EBS Part No	Alternative	Application			Image
30.01.1029	1195759	Length = 3.55M Angled			
30.01.1030A/B	20528660 21247147 21247154	Length = 2.65M Straight Armour Coated Cable & Grommet Seal 1 x Insert "A" & 1 x Insert "B"			
30.01.1064	20428946 20428948	Length = 2.27M Angled Armour Coated Cable & Grommet Seal			
30.01.1080	20490824	Length = 2.15M Angled Comprises of 3x Various Grommets. 3 x Various Plug Casings. 1 x Cable of 115mm			
30.01.1082A/B	21150949 21150950 21363484	Length = 2.00M Angled 1 x Insert "A" & 1 x Insert "B"			
30.01.1083A/B	21363478 21363479	Length = 2.50M Angled 1 x Insert "A" & 1 x Insert "B"			
30.01.1084A/B	21360516 21364022	Length = 4.00M Angled Grommet Seal 1 x Insert "A" & 1 x Insert "B"			
30.01.1085A/B	21152083 21152088 21363477 21363487	Length = 5.50M Angled 1 x Insert "A" & 1 x Insert "B"			
30.01.1093A/B	20732821 20732822 20916171 20916173 21363493 21363495	Length = 5.55M Straight 1 x Insert "A" & 1 x Insert "B"			

ABS SENSORS - VOLVO					
EBS Part No	Alternative	Application			Image
30.01.1096	20428941 20428942	Length = 2.50M Angled			
30.01.1097	9955936	Length = 2.25M Angled			
30.01.1101	21097072	Length = 2.85M Straight			
	4410323740				
30.01.1102	20528657	Length = 2.68M Straight			
	4410329540				
30.01.1103C/D	21097076 21097077	Length = 2.25M Straight			
	4410323670 4410323680				
30.01.1104	20554958	Length = 2.63M Angled			
	4410329740				
30.01.1105	20554959	Length = 2.63M Angled			
30.01.1119	21379916 4410321100 70351557	Length = 3.1M Angled			
30.01.3146	21296829 4410353010	Length = 1.5M Straight			

SENSORS & ASSOCIATED PRODUCTS

ABS SENSORS - VOLVO

EBS Part No	Alternative	Application			Image
30.01.3147	21296851	Length = 2.85M Angled			
30.01.3148	21296853	Length = 2.70M Angled			
30.01.3149	2196849	Length = 1.75M Straight			
30.04.1022	20589620	Length = 2.50M Angled			
30.04.1047	9958574	Length = 1M Angled			

CABLE HARNESS - VOLVO

EBS Part No	Alternative	Information			Image
30.11.4000	20921220	VOLVO CABLE HARNESS			

ABS SENSORS - WABCO

EBS Part No	Alternative	Information	Image		
30.01.1000	4410325730	Length = 1.00M Straight			
30.01.1001	4410328090	Length = 1.00M Angled			
30.01.1002	4410329632	Length = 0.40M Straight			
30.03.1002	4410329632 As 30.01.1002 But Cable Dia is 6.2mm	Length = 0.40M Straight			
30.01.1003	4410329212	Length = 0.40M Angled			
30.03.1001	4410329212 As 30.01.1003 But Cable Dia is 6.2mm	Length = 0.40M Angled			
30.01.1004	4410323820	Length = 1.70M Straight			
30.01.1006	4410321080 4410328130 4410329662 4410329762	Length = 1.70M Angled			
30.01.1009	4410328210	Length = 1.26M Angled Armour Coated Cable			

SENSORS & ASSOCIATED PRODUCTS

ABS SENSORS - WABCO

EBS Part No	Alternative	Information	Image	
30.01.1014	4410323310 4410329220	Length = 2.50M Straight Armour Coated Cable		
30.01.1017	4410321070	Length = 0.85M Angled		
30.01.1018A/B	4410323510 4410329530 4410329550 4410329950	Length = 2.00M Straight 1 x Insert "A" & 1 x Insert "B"		
30.01.1020	4410328740	Length = 1.40M Angled		
30.01.1021	4410321190 4410325770 4410328700 4410329892	Length = 1.50M Angled Armour Coated Cable		
30.01.1022A/B	4410323210 4410323220 4410329430 4410329440 4410329520 4410329932	Length = 1.80M Straight Armour Coated Cable 1 x Insert "A" & 1 x Insert "B"		
30.01.1023	4410324100 4410327290 4410329100	Length = 1.15M Straight		
30.01.1024A/B	4410321150 4410321160 4410321170 4410328710 4410328900	Length = 2.80M Angled Armour Coated Cable 1 x Insert "A" & 1 x Insert "B"		
30.01.1025A/B	4410323230 4410323240 4410323250 4410323350 4410324010 4410329020 4410329510	Length = 2.68M Straight Armour Coated Cable 1 x Insert "A" & 1 x Insert "B"		

ABS SENSORS - WABCO					
EBS Part No	Alternative	Information	Image		
30.01.1026A/B	4410323470 4410323480 4410323880 4410323890 4410329680 4410329780 8840166580	Length = 4.30M Straight Armour Coated Cable & Grommet Seal 1 x Insert "A" & 1 x Insert "B"			
30.01.1029	4410320700 4410320920 4410329202	Length = 3.55M Angled			
30.01.1030A/B	4410323860 4410323870 4410329500 4410329560	Length = 2.65M Straight 1 x Insert "A" & 1 x Insert "B"			
30.01.1031	4410328200	Length = 1.35M Angled Armour Coated Cable			
30.01.1015	4410329230	Length = 3.00M Straight			
30.01.1041	4410326460	Length = 2.00M Angled Mounting Bracket & Guide Pipes			
30.01.1042	4410328630	Length = 2.00M Angled			
30.01.1044	4410321710 4410328110 4410329742	Length = 0.25M Angled			
30.01.1045	4410328670 4410329832	Length = 1.00M Angled Armour Coated Cable			

SENSORS & ASSOCIATED PRODUCTS

ABS SENSORS - WABCO

EBS Part No	Alternative	Information	Image	
30.01.1046	4410320720 4410320830 4410329882	Length = 1.90M Angled		
30.01.1047	4410321040	Length = 1.43M Angled Armour Coated Cable		
30.01.1048	4410328680 4410328690 4410328860 4410328870 4410329822	Length = 2.68M Angled Armour Coated Cable		
30.01.1049	4410329090 4410329812	Length = 1.43M Straight Armour Coated Cable		
30.01.1050	4410329170 4410329250 4410329802	Length = 2.67M Straight Armour Coated Cable		
30.01.1051	4410321180 4410328640 4410329902	Length = 1.15M Angled Armour Coated Cable		
30.01.1052	4410329150 4410329912	Length = 2.15M Straight Armour Coated Cable		
30.01.1053	4410325550 4410325940 4410329372 4410329382	Length = 2.24M Angled Armour Coated Cable & Grommet Seal		
30.01.1054	4410328650 4410328850 4410329782	Length = 2.68M Angled Armour Coated Cable		

ABS SENSORS - WABCO					
EBS Part No	Alternative	Information	Image		
30.01.1055	4410329160 4410329240 4410329852	Length = 2.67M Straight Armour Coated Cable			
30.01.1056A/B	4410321140 4410328720 4410328890	Length = 2.00M Angled Armour Coated Cable 1 x Insert "A" & 1 x Insert "B"			
30.01.1057A/B	4410323280 4410323360 4410323530 4410323540 4410329030 4410329040 4410329872	Length = 3.40M Straight Armour Coated Cable 1 x Insert "A" & 1 x Insert "B"			
30.01.1058	4410325910	Length = 2.05M Angled			
30.01.1059C/D	4410329060 4410329070	Length = 2.68M Straight Armour Coated Cable 1 x Insert "C" & 1 x Insert "D"			
30.01.1062	4410329870 4410353430	Length = 3.00M Straight Armour Coated Cable			
30.01.1063	4410329880 4410353440	Length = 3.00M Straight Armour Coated Cable			
30.01.1064	4410328960 4410328970 4410328980 4410328990	Length = 2.27M Angled Armour Coated Cable & Grommet Seal			
30.01.1068	4410324770 4410327850 4410327880	Length = 0.93M Angled Armour Coated Cable			

SENSORS & ASSOCIATED PRODUCTS

ABS SENSORS - WABCO

EBS Part No	Alternative	Information	Image		
30.01.1069	4410327870	Length = 0.93M Angled Armour Coated Cable			
30.01.1070	4410323430	Length = 3.00M Straight Armour Coated Cable			
30.01.1071	4410323440	Length = 3.00M Straight Armour Coated Cable			
30.01.1072	4410321770 4410321780	Length = 2.60M Angled			
30.01.1075	4410321790	Length = 4.20M Angled			
30.01.1076	4410323770 4410323780	Length = 2.60M Straight			
30.01.1077	4410323790	Length = 4.20M Straight			
30.01.1078	4410328880 4410329792	Length = 2.15M Angled Armour Coated Cable			
30.01.1079	4410329140 4410329952	Length = 2.15M Straight Armour Coated Cable			

ABS SENSORS - WABCO					
EBS Part No	Alternative	Information	Image		
30.01.1081	4410324760	Length = 0.50M Straight			
30.01.1082A/B	4410323330	Length = 2.00M Angled Grommet Seal 1 x Insert "A" & 1 x Insert "B"			
30.01.1083A/B	4410321480 4410321490 4410323320	Length = 2.50M Angled Grommet Seal 1 x Insert "A" & 1 x Insert "B"			
30.01.1084A/B	4410321430 4410321440 4410321460 4410321510	Length = 4.00M Angled Grommet Seal 1 x Insert "A" & 1 x Insert "B"			
30.01.1085A/B	4410321470 4410321500	Length = 5.50M Angled Grommet Seal 1 x Insert "A" & 1 x Insert "B"			
30.01.1088	4410321250	Length = 2.00M Angled Armour Coated Cable & Grommet Seal			
30.01.1089	4410321260	Length = 2.00M Angled Armour Coated Cable & Grommet Seal			
30.01.1093A/B	4410329890 4410329930	Length = 5.55M Straight 1 x Insert "A" & 1 x Insert "B"			
30.01.1094	4410325620 4410326250 8848303170	Length = 1.94M Angled			

SENSORS & ASSOCIATED PRODUCTS

ABS SENSORS - WABCO

EBS Part No	Alternative	Information	Image	
30.01.1096	4410328910 4410328920	Length = 2.50M Angled		
30.01.1097	4410328000 4410328010	Length = 2.25M Angled		
30.01.1098	4410329652	Length = 1.20M 2 x Male Pins		
30.01.1099	4410326710	Length = 1.43M Angled		
30.01.1100	4410321750	Length = 4.2M Angled		
30.01.1101	4410323740	Length = 2.85M Straight		
30.01.1102	4410329540	Length = 2.68M Straight		
30.01.1103C/D	4410323670	Length = 2.25M Straight		
30.01.1104	4410329740	Length = 2.63M Angled		

ABS SENSORS - WABCO

EBS Part No	Alternative	Information	Image		
30.01.1105	4420329750	Length = 2.63M Angled			
30.01.1106	4410329080	Length = 1.425M Straight			
30.01.1107	4410325170	Angled			
	4410325170				
30.01.1108	4410325180	Angled			
30.01.1110	4410326230 4410326240	Length = 4.2M Angled			
30.01.1112	4410359242	Length = 2.3M Angled			
30.01.1113	4410321930	Length = 1.95M Angled			
30.01.1116	4410329710	Length = 2.0M			
30.01.1118	4410353510	Length = 1.65M			

SENSORS & ASSOCIATED PRODUCTS

ABS SENSORS - WABCO

EBS Part No	Alternative	Information	Image		Image
30.01.2500	8840104090	Length = 0.16M Angled			
30.01.2550	4410322550	Length = 0.15M Angled			
30.01.2560	4410322560	Length = 2.60M Angled			
30.01.2580	4410322580	Length = 2.00M Angled Armour Coated			
30.01.2590	4410322590	Length = 2.00M Angled Armour Coated			
30.01.2610	4410322610	Length = 2.00M Angled Grommet Seal			
30.01.2630	4410322630	Length = 2.07M Angled			
30.01.2640	4410322640	Length = 2.07M Angled			
30.01.2650	4410322560 4410322650	Length = 2.60M Angled Armour Coated Cable			

ABS SENSORS - WABCO					
EBS Part No	Alternative	Information	Image		
30.01.2660	4410322570 4410322660	Length = 2.60M Angled Armour Coated Cable			
30.01.2670	4410322670	Length = 1.70M Angled Armour Coated Cable			
30.01.2730	4410322730	Length = 2.40M Angled Grommet Seal			
30.01.2770	4410322770	Length = 2.00M Straight Armour Coated Cable			
30.01.2780	4410322780	Length = 3.6M Angled Armour Coated Cable			
30.01.2790	4410322780	Length = 3.6M Angled Armour Coated Cable			
30.01.2880	4410322880	Length = 2.07M Straight Armour Coated Cable			
30.01.2890	4410322890	Length = 2.07M Straight Armour Coated Cable			
30.01.2900	4410322900	Length = 2.60M Straight Armour Coated Cable			

SENSORS & ASSOCIATED PRODUCTS

ABS SENSORS - WABCO

EBS Part No	Alternative	Information	Image	
30.01.2910	4410322910	Length = 2.60M Straight Armour Coated Cable		
30.01.2920	4410322920	Length = 3.00M Straight Armour Coated Cable		
30.01.2930	4410322930	Length = 2.80M Straight Armour Coated Cable		
30.01.2940	4410322940	Length = 3.30M Straight Armour Coated Cable		
30.01.2960	4410322960	Length = 2.07M Straight Armour Coated Cable		
30.01.2970	4410322970	Length = 2.07M Straight Armour Coated Cable		
30.01.2980	4410322980	Length = 2.60M Straight Armour Coated Cable		
30.01.2990	4410322990	Length = 2.60M Straight Armour Coated Cable		
30.01.3001	4410350010	Length = 0.40M Straight		



ABS SENSORS - WABCO					
EBS Part No	Alternative	Information	Image		
30.01.3107	4410321120 4410321630 4410351070 4410351130 8840168930	Length = 1.30M Angled Armour Coated Cable			
30.01.3108	4410321130 4410321640 4410351080 4410351140 8840168940	Length = 1.30M Angled Armour Coated Cable			
30.01.3111	4410351090 4410351110	Length = 2.30M Angled Armour Coated Cable & Grommet Seal			
30.01.3112	4410351100 4410351120	Length = 2.30M Angled Armour Coated Cable & Grommet Seal			
30.01.3115	4410351150	Length = 3.00M Angled Armour Coated Cable & Grommet Seal			
30.01.3150	4410351470 1870628	Length = 1.7M Angled			
30.01.3151	4410353360	Length = 3.25M Straight			
30.01.3116	4410351160	Length = 3.50M Angled Armour Coated Cable & Grommet Seal			
30.01.10000	4410323400	Length = 0.8 M Straight			

SENSORS & ASSOCIATED PRODUCTS

ABS SENSORS - WABCO

EBS Part No	Alternative	Information	Image	
30.03.1001	4410329212	Length = 0.40M Angled Grommet Seal As 30.01.1003 But Cable Dia is 6.2mm		
30.03.1002	4410329632	Length = 0.40M Straight Grommet Seal As 30.01.1002 But Cable Dia is 6.2mm		
30.04.1009	4410327830	Length = 1.40M Angled Armour Coated Cable & Grommet Seal		
30.04.1010	4410327840	Length = 1.40M Angled Armour Coated Cable & Grommet Seal		































WHEEL SPEED SENSORS - IVECO DAILY

EBS Part No	Alternative	Information	Application	Image
30.04.2005	0265008429	Wheel Speed Sensor	IVECO DAILY	
30.04.10000	0265008414	Wheel Speed Sensor (1.3 M)	IVECO DAILY	
30.04.10001	0268008430	Wheel Speed Sensor (1.25 M)	IVECO DAILY	

EXTENSION CABLES - ABS SENSORS - HALDEX					
EBS Part No	Alternative	Information			Image
---	950800441	Length = 3.00M To extend EBS EB+ Speed Sensors			
---	950800442 814004421	Length = 2.00M To extend EBS EB+ Speed Sensors			
---	950800443 814004411	Length = 6.00M To extend EBS EB+ Speed Sensors			
---	950800444	Length = 10.00M To extend EBS EB+ Speed Sensors			
---	950800445	Length = 14.00M To extend EBS EB+ Speed Sensors			
---	950800446	Length = 8.00M To extend EBS EB+ Speed Sensors			
---	950800447	Length = 12.00M To extend EBS EB+ Speed Sensors			

SENSORS & ASSOCIATED PRODUCTS

EXTENSION CABLES - ABS SENSORS - WABCO

EBS Part No	Alternative	Information			Image
30.11.0080	4497120080	Length = 0.80M To extend ABS & EBS Speed Sensors			
30.11.0180	4497120180	Length = 1.80M To extend ABS & EBS Speed Sensors			
30.11.0230	4497120230	Length = 2.30M To extend ABS & EBS Speed Sensors			
30.11.0300	4497120300	Length = 3.00M To extend ABS & EBS Speed Sensors			
30.11.0380	4497120380	Length = 3.80M To extend ABS & EBS Speed Sensors			
30.11.0400	4497120400	Length = 4.00M To extend ABS & EBS Speed Sensors			
30.11.0510	4497120510	Length = 5.10M To extend ABS & EBS Speed Sensors			
30.11.0600	4497120600	Length = 6.00M To extend ABS & EBS Speed Sensors			
30.11.0800	4497120800	Length = 8.00M To extend ABS & EBS Speed Sensors			
30.11.1000	4497121000	Length = 10.00M To extend ABS & EBS Speed Sensors			

ADAPTOR CABLES			
EBS Part No	Alternative	Information	Image
EKWA.110.3	8946011322	Length = 0.15M Adaptor Cable From Kostal Connector Into DIN Bayonet Plug = Bayonet (DIN) Port Threads = M24 x 1.5	
EKWA.110.92	8946011392	Length = 0.30M Adaptor Cable From DIN Bayonet Into Female DIN	
EKWA.110.20	---	Length = 0.15M Adaptor Cable From Square Plug Into DIN Bayonet	
EKWA.110.21	---	Length = 0.15M Adaptor Cable From Square Plug Into Round Female Plug	
EKWA.110.32	8946011332	Length = 0.15M Adaptor Cable From DIN Bayonet Cable To Kostal	
EKWA.110.82	8946011382	Length = 0.75M "Y" Adaptor Cable From Male DIN to 2 x Female DIN Plugs	
30.29.2012	1741865 20382517	Length = 0.17M 4 Wire Adaptor Cable To Convert Into A Bayonet Plug.	

SENSOR ACCESSORIES			
EBS Part No	Alternative	Information	Image
30.99.0000	8997605104 1116774 059512309	Replacement Bush for ABS Sensors	 ID= 18mm
30.99.0001	---	Grease Sachet for ABS Sensor	
30.99.0002	8997598820	Replacement Small Bush for ABS Sensors	 ID= 13mm
30.99.0003	20726986 7420726986	ABS Sensor Retainer for VOLVO/RENAULT	

SENSORS & ASSOCIATED PRODUCTS

SENSOR ACCESSORIES



EBS Part No	Alternative	Information	Image
30.99.0004	0318907580	ABS Sensor Retainer for BPW	
30.99.0005	0318907590	ABS Sensor Retainer for BPW	
30.99.0006	0318911770	ABS Sensor Retainer for BPW	
30.99.0007	0318912020	ABS Sensor Retainer for BPW	
30.99.0008	0318914610	ABS Sensor Retainer for BPW	

CONNECTING CABLES - MAN

EBS Part No	Alternative	Information	Image
30.11.2004	81.25429.6893	Caliper Connecting Cable Length = 1.75M	

CONNECTING CABLES - WABCO

EBS Part No	Alternative	Information	Image
30.11.5003	4497230030	Connecting Cable EBS E Length = 0.3M	
30.11.5018	4497230180	Connecting Cable EBS E Length = 1.8M	
30.11.5023	4497230230	Connecting Cable EBS E Length = 2.3M	
30.11.5030	4497230300	Connecting Cable EBS E Length = 3M	

CONNECTING CABLES - WABCO			
EBS Part No	Alternative	Information	Image
30.11.5040	4497230400	Connecting Cable EBS E Length = 4M	
30.11.5080	4497230800	Connecting Cable EBS E Length = 8M	
30.11.5100	4497231000	Connecting Cable EBS E Length = 10M	

EBS KNORR BREMSE CALIPER EXTENSION CABLES			
EBS Part No	Alternative	Information	Image
30.11.2001	2064774	Extension cable for Knorr Bremse caliper sensor Length = 1.2M	
30.11.2002	2064775	Extension cable for Knorr Bremse caliper sensor Length = 1.2M	

EBS MAN CALIPER SENSOR CONNECTING CABLE			
EBS Part No	Alternative	Information	Image
30.11.2003	81.25429.6894	Caliper Sensor Connecting Cable Length=1.7M	

EBS MERCEDES WEAR SENSOR CABLE			
EBS Part No	Alternative	Information	Image
30.11.10008	A0005404136	Wear Sensor Connecting Cable	

EBS SCANIA WEAR SENSOR CABLE			
EBS Part No	Alternative	Information	Image
30.11.2000	1884529	Wear sensor cable for SCANIA 4 SEIRES Length = 1.5M WITHOUT SCRES	

EBS WABCO CALIPER SENSOR CONNECTING CABLE			
EBS Part No	Alternative	Information	Image
30.11.2020	4497560200	Caliper Sensor Connecting Cable Length =2M	

SENSORS & ASSOCIATED PRODUCTS

AIR PRESSURE SENSORS









EBS Part No	Alternative	Information	Application	Image
30.01.4001	1652528 0015421718 0025425818 A0015421718 A0025425818 4410441010	Pressure Sensor	DAF MERCEDES	
30.01.4002	4410441090	Pressure Sensor	IVECO	
30.01.4003	4410400150	Pressure Sensor	DAF MAN	
30.01.4004	4410441040	Pressure Sensor	DAF MAN	
30.01.4006	4410441080	Pressure Sensor	DAF IVECO	
30.01.4007	4410442030	Pressure Sensor	SCANIA	
30.01.4008	4410442010 A0075426018	Pressure Sensor	MERCEDES	
30.04.2002	0281002576 0281002743 5010437653 501073323 201149033 5010437653 5010450894 20524936	Boost Pressure	RENAULT KAMAZ VOLVO IVECO	
30.04.2003	0484205006N00 504049819 81274210202 5010143084 1362168 3173630	Pressure Sensor	KNORR	
30.05.2000	630767	Pressure Sensor	KONGSBERG	

AIR PRESSURE SENSORS

EBS Part No	Alternative	Information	Application	Image
30.05.2001	627111	Pressure Sensor	MERCEDES	
30.10.0003	0041531828	Boost Pressure	MERCEDES	
30.10.0007	0041537028 0041537628	Boost Pressure	MERCEDES	
30.21.2001	1398468	Boost Pressure	DAF	
30.21.2016	1326649	Boost Pressure	DAF	
30.21.2019	1826279	Boost Pressure	DAF	
30.26.2004	51094136000	Air Mass	MAN	
30.26.2006	51274210102	Boost Pressure	MAN	
30.26.2010	51274210173 51274210181	Boost Pressure	MAN	
30.26.2015	81225200079	Pressure	MAN	

SENSORS & ASSOCIATED PRODUCTS

AIR PRESSURE SENSORS

EBS Part No	Alternative	Information	Application	Image
30.26.2034	51.27421.0216	Boost Pressure	MAN	
30.26.2037	81.27421.6047	Engine Pressure	MAN	
30.26.2038	81.27421.0151	Air Pressure	MAN	
30.27.2014	A0045455514	Air Pressure	MERCEDES	
30.27.2021	0041532028	Boost Pressure Sensor	MERCEDES	
30.27.2032	A0061537428	Pressure	MERCEDES	
30.27.2033	A0061537528	Pressure	MERCEDES	
30.27.2038	0065420318	Air Pressure	MERCEDES	
30.29.2003	20552760 20909613 3172524	Air Pressure	VOLVO	
30.29.2004	1457305 1535520 1787155 1862787 1862797 535520	Charge Pressure	SCANIA	

AIR PRESSURE SENSORS

EBS Part No	Alternative	Information	Application	Image
30.29.2017	1862895	Air Pressure	SCANIA	
30.29.2018	1767616	Air Pressure	SCANIA	
30.30.2000	20428459 20528336 20829689 8158821	Air Pressure	VOLVO	
30.30.2010	20374280 20478260 20706889	Turbine Pressure	VOLVO	
30.30.2032	20382508	Pressure (see 30.30.2032C for full Kit)	VOLVO	
30.30.2032C	1087963 1594040 1622986	Pressure As 30.30.2032 but this is a Complete Kit	VOLVO	
30.30.2070	21097978 22329559 22422785	Boost Pressure	VOLVO	
30.30.2071	20761735 21068286	I-Shift Pressure	VOLVO	
30.30.10001	20912144	Air Pressure Sensor	VOLVO	
30.30.10003	22677703	Air Pressure Sensor	VOLVO	

SENSORS & ASSOCIATED PRODUCTS

BRAKE SENSORS

EBS Part No	Alternative	Information	Application	Image
30.30.2033	3172522	Pressure	VOLVO	
30.30.2043	20382504 3034073	Brake Pressure	VOLVO	
30.30.2044	3963479	Brake Pressure	VOLVO	
30.30.2045	20382518 8157359	Brake Pressure	VOLVO	
30.30.2046	1087960 1594037 1622983 20382505	Brake Pressure	VOLVO	
30.30.2047	20382506	Brake Pressure	VOLVO	
30.30.2048	1078493 3197870	Brake Light Switch	VOLVO	
30.30.2049	1087967 1606786 1623785 20382511	Brake Pressure	VOLVO	
30.30.2050	1607252 1622989 20382510 2087965	Brake Pressure	VOLVO	
30.30.2051	20424051 3963471	Brake Pressure	VOLVO	
30.30.2052	20424056 3963476	Brake Pressure	VOLVO	





BRAKE SENSORS				
EBS Part No	Alternative	Information	Application	Image
30.30.2053	20424060	Brake Pressure	VOLVO	
30.30.2054	20424066 3963486	Brake Pressure	VOLVO	
30.30.2055	1087962 1594039 1622985 20382507	Brake Pressure	VOLVO	
30.30.2056	1087964 1594041 1613280 1622987 20382509 3944592	Brake Pressure	VOLVO	
30.30.2057	3197871	Brake Light Switch	VOLVO	
30.30.2058	20382500 6796031	Brake Pressure	VOLVO	
30.30.2059	1662926 20853399 21095380 21318083 85116453	Brake Pressure	VOLVO	
30.30.2062	533633 81255200010 81255200021 81255206006 0007631410 158717 1571540	Brake Light Switch	DAF MAN MERCEDES SCANIA VOLVO	
30.30.2067	3987498	Pressure	VOLVO	
30.30.2072	21345733	Pressure	VOLVO	

SENSORS & ASSOCIATED PRODUCTS

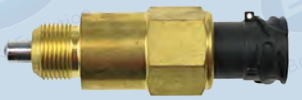

CAB SENSORS

EBS Part No	Alternative	Information	Application	Image
30.26.2024	81255200161	Cab Tilt Sensor	MAN	

DISTANCE SENSORS

EBS Part No	Alternative	Information	Application	Image
30.27.2001	4411000640 0005459209	Distance Sensor (EDS)	MERCEDES	
30.27.2002	4411000710	Distance Sensor (EDS)	MERCEDES	
30.27.2003	4411000720 0005429118	Distance Sensor (EDS)	MERCEDES	
30.27.2020	4411000630 5429018	Distance Sensor (EDS)	MERCEDES	

DOOR SENSORS



EBS Part No	Alternative	Information	Application	Image
30.27.4001	4461901500 A0018214860	Door Sensor	MERCEDES	
30.27.4003	4461901520	Door Sensor	MERCEDES	



ENGINE MANAGEMENT SENSORS				
EBS Part No	Alternative	Information	Application	Image
30.02.1010	0011532120	RPM Sensor	MERCEDES	
30.04.2000	51271207037	RPM Sensor	MAN	
30.04.2001	51271207038	RPM Sensor	MAN	
30.10.0001	0011532120	RPM Sensor	MERCEDES	
30.21.2000	1398467	Crankshaft Sensor	DAF	
30.21.2003	361799	Speed Sensor	DAF	
30.26.2000	51271200008	Crankshaft Sensor	MAN	
30.26.2001	51271200009	Crankshaft Sensor	MAN	
30.26.2002	51271200014	RPM Sensor	MAN	
30.26.2003	51271200015	RPM Sensor	MAN	
30.27.2006	0155422417	RPM Sensor	MERCEDES	



SENSORS & ASSOCIATED PRODUCTS



ENGINE MANAGEMENT SENSORS

EBS Part No	Alternative	Information	Application	Image
30.27.2010	A0065424617	RPM Sensor	MERCEDES	
30.27.2011	A0095421017	RPM Sensor	MERCEDES	
30.27.2019	A0155422717	RPM Sensor	MERCEDES	
30.28.2001	5010412449 20513343	Camshaft Sensor	RENAULT VOLVO	
30.29.2036	1783287	Crankshaft Position Sensor	SCANIA	
30.29.2037	1783288	Crankshaft Position Sensor	SCANIA	
30.30.1000	20374282	Crankshaft Sensor	VOLVO	
30.30.2008	20508011	RPM Sensor	VOLVO	
30.30.2013	3171490	RPM Sensor	VOLVO	
30.30.2014	3195815	Rotate Speed Sensor	VOLVO	
30.30.2029	3944124	RPM Sensor	VOLVO	

ENGINE MANAGEMENT SENSORS				
EBS Part No	Alternative	Information	Application	Image
30.30.2035	3515093 8141475	RPM Sensor	VOLVO	
30.30.2086	20861966	Speed Sensor	VOLVO	

FLYWHEEL SENSORS				
EBS Part No	Alternative	Information	Application	Image
30.01.1073	1457303	Length = 1.70M Angled	SCANIA	
30.01.1074	1457304	Length = 1.90M Angled	SCANIA	

FUEL PRESSURE SENSOR				
EBS Part No	Alternative	Information	Application	Image
30.04.4001	0281002937	Fuel Pressure Sensor	BOSCH	
30.26.10001	51.27421.0233	Fuel Pressure Sensor	MAN	

GEARBOX SENSORS				
EBS Part No	Alternative	Information	Application	Image
30.29.2041	1471738	Gearbox Rotation Sensor	SCANIA	
30.30.2088	4213659292 20562642	Gearbox Position Sensor	VOLVO	

SENSORS & ASSOCIATED PRODUCTS

LEVEL SENSORS

EBS Part No	Alternative	Information	Application	Image
30.21.2005	1781197	Adblue Level	DAF	
30.21.2008	1624783	Coolant Level	DAF	
30.21.2014	1327199	Water Level	DAF	
30.21.2015	1624784	Water Level	DAF	
30.21.2020	1740757	Water Level	DAF	
30.26.2008	81274210152 81274210169	Water Level	MAN	
30.26.2041	81.27421.0232	Oil Level	MAN	
30.27.2005	0041534428	Oil Level	MERCEDES	
30.27.2007	9425420	Coolant Level	MERCEDES	
30.27.2012	A970545012	Coolant Level	MERCEDES	

LEVEL SENSORS				
EBS Part No	Alternative	Information	Application	Image
30.27.2016	A0135427117	Fuel Level	MERCEDES	
30.27.2017	A0135427217	Fuel Level	MERCEDES	
30.27.2018	A0041536328	Oil Level	MERCEDES	
30.27.2024	0031539828	Oil Level	MERCEDES	
30.27.2035	0061531228	Oil Level	MERCEDES	
30.27.2036	9605420617	Fill Level Sensor	MERCEDES	
30.27.10000	0091532928	Oil Level	MERCEDES	
30.28.2003	5010477145	Oil Level	RENAULT	
30.28.2008	5010514270	Coolant Level	RENAULT	

SENSORS & ASSOCIATED PRODUCTS

LEVEL SENSORS

EBS Part No	Alternative	Information	Application	Image
30.28.2010	5010360058	Oil Level	RENAULT	
30.28.2011	5010311958	Air Pressure	RENAULT	
30.28.2012	7420981961	Fuel Level Sensor	RENAULT	
30.29.2020	1374052	Coolant Level	SCANIA	
30.29.2033	1304725	Coolant Level	SCANIA	
30.30.2016	21399626 8140024	Water Level	VOLVO	
30.30.2031	21042447 21521353 24424110 3173797	Oil Level	VOLVO	
30.30.2073	20428462	Fuel Level Sensor	VOLVO	
30.30.2076	21159001	Water Level Sensor	VOLVO	

OIL PRESSURE SENSORS				
EBS Part No	Alternative	Information	Application	Image
30.21.2006	1673078	Oil Pressure	DAF	
30.25.2000	99484667	Oil Pressure	IVECO	
30.26.2009	81274210098 81274210109	Oil Pressure	MAN	
30.26.2012	81274210184 81274210230 81274210251 81274210262 81274216043 81274216048	Oil Pressure	MAN	
30.26.2013	81255140032 81255140210 81255146004	Oil Pressure	MAN	
30.26.2016	81274210097	Oil Pressure	MAN	
30.26.2035	51.27421.000	Oil Pressure	DAF	
30.26.2043	51.27421.0263	Oil Pressure	MAN	
30.27.2000	A0001539932	Oil Pressure	MERCEDES	

SENSORS & ASSOCIATED PRODUCTS

OIL PRESSURE SENSORS

EBS Part No	Alternative	Information	Application	Image
30.27.2008	0015428217	Oil Pressure	MERCEDES	
30.27.2009	0125420517	Oil Pressure	MERCEDES	
30.27.2023	0071530828	Oil Pressure	MERCEDES	
30.27.2034	0004660718	Oil Dipstick Sensor	MERCEDES	
30.28.2000	5010398062 40218801	Oil Pressure	RENAULT VOLVO	
30.28.2004	5010311958	Air Pressure	RENAULT	
30.28.2007	5010311242	Oil Pressure	RENAULT	
30.28.2009	5010437049	Oil Pressure	RENAULT	
30.29.1000	1457306 1535521 1862892	Oil Pressure	SCANIA	
30.29.2001	1393113 1452862 1488340 1881260	Oil Pressure	SCANIA	

OIL PRESSURE SENSORS				
EBS Part No	Alternative	Information	Application	Image
30.29.2002	1403060 1527108 1784638 1862800	Oil Pressure	SCANIA	
30.29.2005	1383578 1383580 1402943 1545634 1784636 1862798	Oil Pressure	SCANIA	
30.29.2006	1358967 1402944 1545635 1784637 1862799 545635	Oil Pressure	SCANIA	
30.29.2010	368851 397946	Oil Pressure	SCANIA	
30.29.2019	374338	Oil Pressure	SCANIA	
30.29.2022	1356751	Oil Pressure	SCANIA	
30.29.2026	1377930	Oil Pressure	SCANIA	
30.30.2001	1077574	Oil Pressure	VOLVO	
30.30.2081	3962894	Oil Pressure	VOLVO	

SENSORS & ASSOCIATED PRODUCTS

OIL PRESSURE SENSORS



EBS Part No	Alternative	Information	Application	Image
30.30.2011	20452439 20484676 20499340 20796744 20905373 21746206	Oil Pressure	VOLVO	
30.30.2012	7420796740 7420898038 7421302639 20898038 21302639 21540602	Oil Pressure	RENAULT VOLVO	
30.30.2015	3962893	Oil Pressure	VOLVO	
30.30.2028	20514065 20803650	Oil Pressure	VOLVO	
30.30.2030	20375013 20428456 20484678 20796740 20886108	Oil Pressure	VOLVO	
30.30.2036	2070351745 70351745	Oil Pressure	VOLVO	
30.30.2066	1594229	Oil Pressure	VOLVO	
30.30.2082	85139619	Oil Pressure	VOLVO	

SENSORS - OTHER				
EBS Part No	Alternative	Information	Application	Image
30.10.0002A	4111005293 4411005312 9700519692	Servo Sensor Plug c/w Push Rod	Fits 970 051 4--- series servos	
30.21.2009	1450194	Fuel Filter Sensor	DAF	
30.21.2010	1388000	Oil Level Sensor	DAF	
30.28.2005	7420513340	Coolant Temperature Sensor	RENAULT	
30.28.2006	5010306719	Light Switch	RENAULT	
30.29.2008	1525891	Wiper Bearing - Left Hand	SCANIA	
30.29.2009	1525892	Wiper Bearing - Right Hand	SCANIA	
30.29.2013	0015451809 0015454909 0015458409 1348509 1394465 1423968 1472738	Reverse Light Switch	MERCEDES SCANIA	
30.29.2015	1378644 1387100 1420005 1423976 1423977 1472739	Reverse Light Switch	SCANIA	

SENSORS & ASSOCIATED PRODUCTS

SENSORS - OTHER

EBS Part No	Alternative	Information	Application	Image
30.29.2021	314572	Reverse Light Switch	SCANIA	
30.29.2032	1911032	Exhaust Pressure Sensor	SCANIA	
30.29.2044	1743181	Gearbox Sensor	SCANIA	
30.29.10000	1774004	Air Flow Sensor	SCANIA	
30.30.2037	20410321 20498094 20514417 20583477 20720686 21643804	Gearbox Impulse Sensor	VOLVO	
30.30.2038	7420870050 7420875073 20208386 20869391 20870050 20875073	Fuel Filter c/w Sensor	RENAULT VOLVO	
30.30.2065	3944080	Reverse Light Switch	VOLVO	
30.30.2060	20771578	Fuel Filter	VOLVO	
30.30.2089	20382529	Cab Lock Sensor	VOLVO	
30.30.10000	21403962	Exhaust Air Intake Pressure Sensor	VOLVO	

PRESSURE CONTROL VALVES				
EBS Part No	Alternative	Information	Application	Image
30.21.2012	0501210058	Brake Light Switch	VOLVO	
30.04.2004	0928400670	Pressure Control	RENAULT	
30.04.3001	0928400627	Pressure Control	MAN	

PEDAL SENSORS				
EBS Part No	Alternative	Information	Application	Image
30.21.2007	1805197	Accelerator Pedal Sensor	DAF	
30.29.2011	1360842	Pedal Sensor	SCANIA	
30.29.2031	1435680	Clutch Pedal Sensor	SCANIA	
30.29.2042	2388630	Brake Pedal Sensor	SCANIA	
30.30.2022	81519590	Pedal Position Sensor 6 Pins	VOLVO	

SENSORS & ASSOCIATED PRODUCTS

PEDAL SENSORS

EBS Part No	Alternative	Information	Application	Image
30.30.2023	3985226	Pedal Position Sensor 5 Pins Black Plug	VOLVO	
30.30.2024	3175135	Pedal Position Sensor 6 Pins Black Plug	VOLVO	
30.30.2025	20504685 20889693 21116874 21116880 21915485	Pedal Position Sensor 5 Pins Grey Plug	VOLVO	
30.30.2026	20893518	Pedal Position Sensor 6 Pins Grey Plug	VOLVO	
30.30.2027	20443824	Pedal Position Sensor	VOLVO	
30.30.2063	85109590	Pedal Position Sensor	VOLVO	
30.30.2069	3092815	Accelerator Pedal Sensor	VOLVO	







THROTTLE PEDAL & SENSOR

EBS Part No	Alternative	Information	Application	Image
30.01.7001	965100010 41227741	Throttle Pedal & Sensor	IVECO	

PRESSURE SWITCHES				
EBS Part No	Alternative	Information	Application	Image
30.21.10002	1826281	Pressure Switch	DAF	
30.01.6001	4410140010	Pressure Switch	WABCO	
30.01.6002	4410140020	Pressure Switch	WABCO	
30.01.6013	4410140130	Pressure Switch	WABCO	
30.01.6015	4410140150	Pressure Switch	WABCO	
30.01.6017	4410140170	Pressure Switch	WABCO	
30.01.6019	4410140190	Pressure Switch	WABCO	
30.01.6020	4410146020	Pressure Switch	WABCO	
30.01.6021	4410140210	Pressure Switch	WABCO	

SENSORS & ASSOCIATED PRODUCTS

PRESSURE SWITCHES

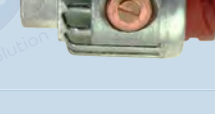
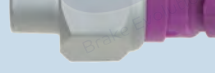
EBS Part No	Alternative	Information	Application	Image
30.01.6025	4410140250	Pressure Switch	WABCO	
30.01.6029	4410140290	Pressure Switch	WABCO	
30.01.6102	4410141020	Pressure Switch	WABCO	
30.01.6104	4410141040	Pressure Switch	WABCO	
30.26.2017	81255200204	Pressure Switch	MAN	
30.26.2018	81225200184	Pressure Switch	MAN	
30.26.2019	81225200171	Pressure Switch	MAN	
30.26.2020	81255200117	Pressure Switch	MAN	
30.26.2021	81255200196	Pressure Switch	MAN	

PRESSURE SWITCHES

EBS Part No	Alternative	Information	Application	Image
30.26.2022	81255200210	Pressure Switch	MAN	
30.26.2023	81274210163	Pressure Switch	MAN	
30.26.2025	81255200055	Pressure Switch	MAN	
30.26.2026	81255200076	Pressure Switch	MAN	
30.26.2027	81255200100	Pressure Switch	MAN	
30.26.2028	81255200152	Pressure Switch	MAN	
30.26.2029	81255200163	Pressure Switch	MAN	
30.26.2030	81274210184	Pressure Switch	MAN	
30.26.2031	81255200167	Pressure Switch	MAN	

SENSORS & ASSOCIATED PRODUCTS

PRESSURE SWITCHES

EBS Part No	Alternative	Information	Application	Image
30.26.2032	81255200190	Pressure Switch	MAN	
30.26.2039	81.25503.0244	Pressure Switch	MAN	
30.27.2004	0045455414	Pressure Switch	MERCEDES	
30.27.2015	A0005455414	Pressure Switch	MERCEDES	
30.27.2037	A0025453914	Pressure Switch	MERCEDES	
30.29.2029	1449771	Pressure Switch	SCANIA	
30.29.2035	1777165	Pressure Switch	SCANIA	

SPEED SENSORS				
EBS Part No	Alternative	Information	Application	Image
30.21.2013	1999959	Speed Sensor	DAF	
30.26.2011	81259090009 81259090036 81274210080 81274210135 81274211040 1448080	Speed Sensor	MAN SCANIA	
30.28.2002	5010135073 1853436	Speed Sensor	RENAULT SCANIA	
30.29.2000	1111459	Speed Sensor	SCANIA	
30.29.2014	395641	Speed Sensor	SCANIA	
30.29.2016	1516563 1742947 1852113 2051403 516563	Speed Sensor	SCANIA	
30.29.2038	1771230	Speed Sensor	SCANIA	
30.29.2039	1888075	Speed Sensor	SCANIA	

SENSORS & ASSOCIATED PRODUCTS

TEMPERATURE SENSORS

EBS Part No	Alternative	Information	Application	Image
30.10.0004	81274210125	Water Temperature	VOLVO	
30.21.2002	1426321 1827058	Water Temperature	DAF	
30.21.2004	1252439	Water Temperature	DAF	
30.21.2017	1810690	Exhaust Temperature Engine Type EURO 5/6	DAF	
30.21.2018	1810691	Exhaust Temperature Engine Type EURO 5/6	DAF	
30.25.2001	5801291815 504102603ZE	Exhaust Temperature Engine Type EURO 5/6	IVECO	
30.25.2002	69502946	Exhaust Temperature Engine Type EURO 5	IVECO	
30.25.2003	504095152	Exhaust Temperature Sensor	IVECO	
30.26.2005	51274210132	Temperature Sensor	MAN	

TEMPERATURE SENSORS				
EBS Part No	Alternative	Information	Application	Image
30.26.2007	81274210237 81274210242 81274210253 81274210264	Exhaust Temperature	MAN	
30.26.2033	51.27421.0172	Water Temperature	MAN	
30.26.2036	51.27421.0078	Temperature Sensor	MAN	
30.26.2040	81274210263	Temperature Sensor	MAN	
30.26.2042	81.27421.0265	Temperature Sensor	MAN	
30.27.2022	A0125421017	Temperature Sensor	MERCEDES	
30.27.2026	0061530628 A1614310103	Exhaust Temperature Sensor Engine Type: EURO 5	MERCEDES	
30.27.2027	A0061530728	Exhaust Temperature Sensor Engine Type: EURO 5	MERCEDES	
30.27.2028	A0061530428	Exhaust Temperature Sensor Engine Type: EURO 5	MERCEDES	

SENSORS & ASSOCIATED PRODUCTS

TEMPERATURE SENSORS

EBS Part No	Alternative	Information	Application	Image
30.27.2029	A0041534228	Water Temperature	MERCEDES	
30.27.2030	A0075424818	Exhaust Temperature Sensor	MERCEDES	
30.27.2031	A0061534528	Temperature Sensor	MERCEDES	
30.29.2023	1526158	Temperature Sensor	SCANIA	
30.29.2024	1871772	Temperature Sensor	SCANIA	
30.29.2025	1491408	Water Temperature	SCANIA	
30.29.2028	1788333	Coolant Temperature Sensor	SCANIA	
30.29.2030	2265872	Exhaust Temperature Sensor	SCANIA	
30.29.2034	1788333	Coolant Temperature Sensor	SCANIA	

TEMPERATURE SENSORS

EBS Part No	Alternative	Information	Application	Image
30.29.2043	1865315	Temperature Sensor	SCANIA	
30.30.2003	1594228	Water Temperature	VOLVO	
30.30.2004	1594225 1612230	Water Temperature	VOLVO	
30.30.2005	1618946	Water Temperature	VOLVO	
30.30.2006	1624361	Water Temperature	VOLVO	
30.30.2007	1662938	Speed Sensor	VOLVO	
30.30.2017	20429956	Water Temperature	VOLVO	
30.30.2018	20576626 3944123	Water Temperature	VOLVO	
30.30.2019	3985651	Water Temperature	VOLVO	

SENSORS & ASSOCIATED PRODUCTS

TEMPERATURE SENSORS

EBS Part No	Alternative	Information	Application	Image
30.30.2020	20374281	Water Temperature	VOLVO	
30.30.2039	9520435	Thermal Temperature	VOLVO	
30.30.2040	21390986	Thermal Temperature	VOLVO	
30.30.2041	1578133 1578134	Water Temperature	VOLVO	
30.30.2042	1594138 8150500	Speed Sensor	VOLVO	
30.30.2061	1624368 1079338	Temperature Sensor	VOLVO	
30.30.2068	8154755	Temperature Sensor	VOLVO	
30.30.2074	20889280	Exhaust Temperature Engine Type: EURO 5	RENAULT & VOLVO	
30.30.2075	21412472	Exhaust Temperature Engine Type: EURO 5/6	VOLVO	

TEMPERATURE SENSORS				
EBS Part No	Alternative	Information	Application	Image
30.30.2077	21010707	Exhaust Temperature Engine Type: EURO 5	VOLVO	
30.30.2078	21225020 7421225020	Exhaust Temperature Engine Type: EURO 5/6	VOLVO	
30.30.2079	21164790 7421164790	Exhaust Temperature Engine Type: EURO 5/6	VOLVO	
30.30.2080	21164792	Exhaust Temperature Engine Type: EURO 5/6	VOLVO	
30.30.2083	20520111	Temperature Sensor	VOLVO	
30.30.2090	21285163	Exhaust Temperature Sensor	VOLVO	

OVERFLOW VALVE			
EBS Part No	Alternative	Application	image
30.29.2027	1917514	SCANIA	

STOP LIGHT SWITCH - CLAYTON DEWANDRE				
EBS Part No	Alternative Part No	Information	Repair Kit	image
21.09.1000	228600	Stop Light Switch 1/4" - 18 NPTF Thread	---	
	262625			
	262694			
	274746			

SENSORS & ASSOCIATED PRODUCTS

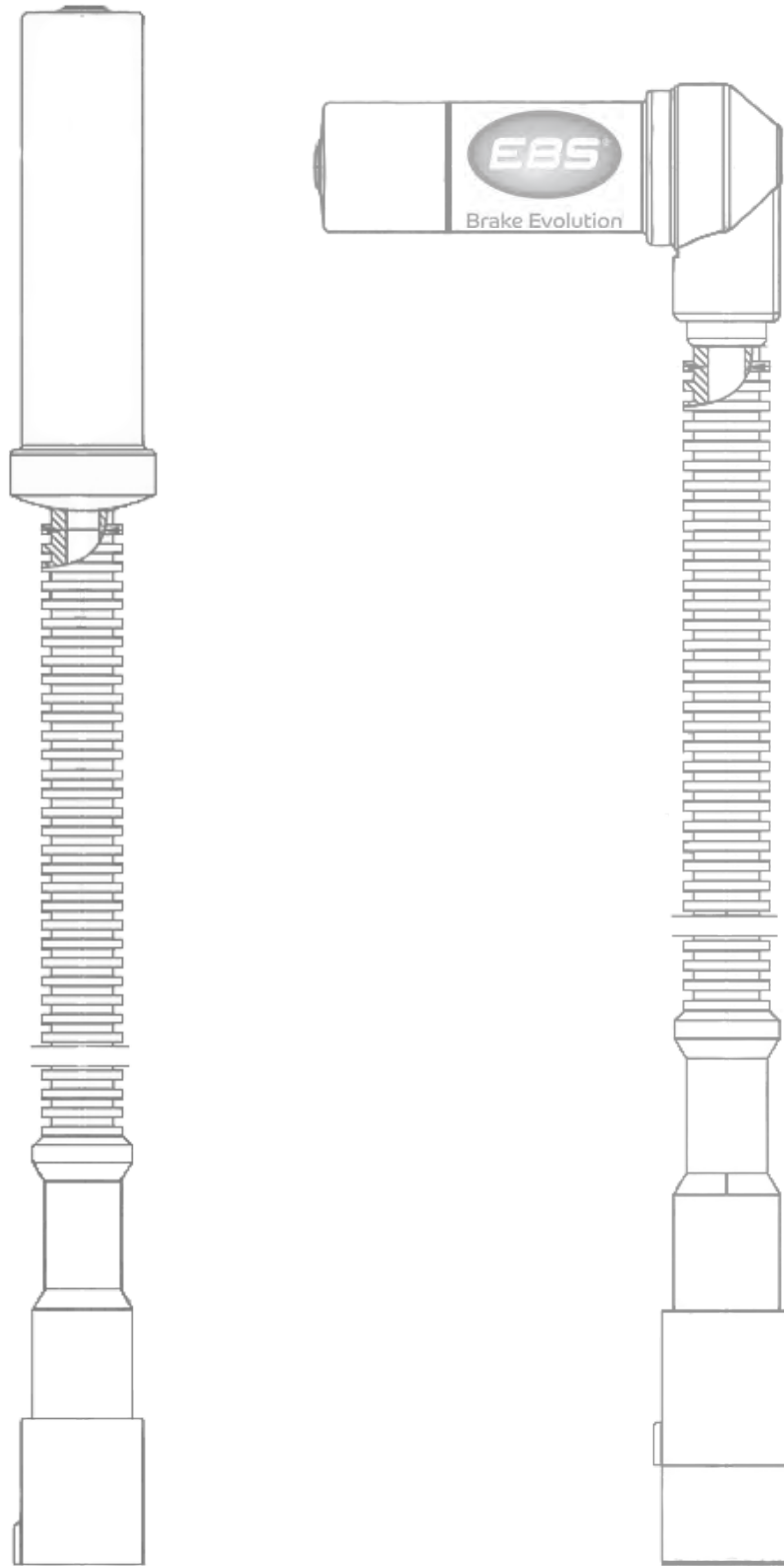

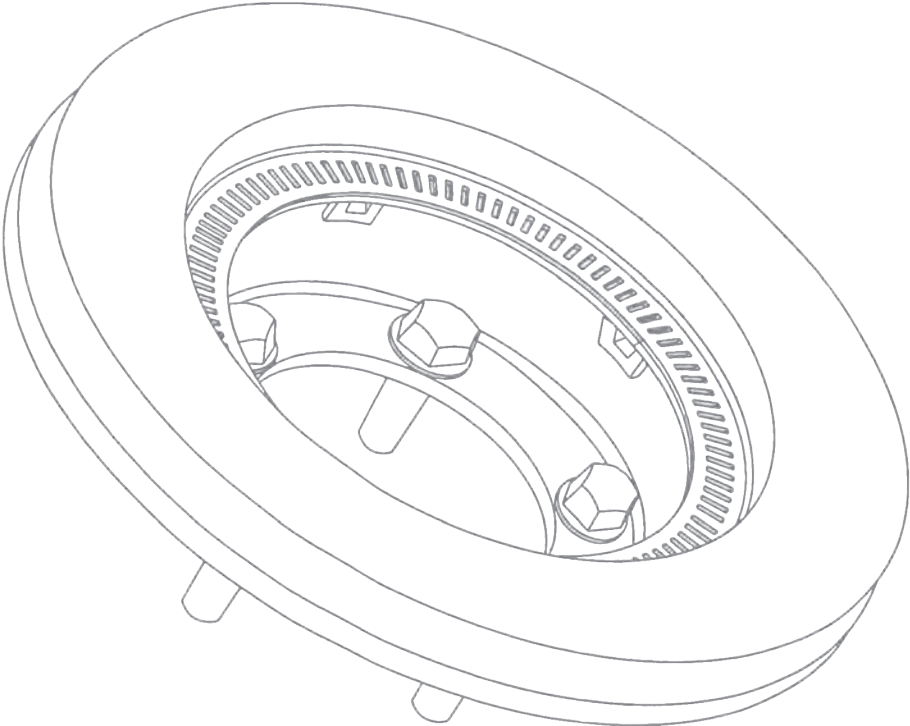
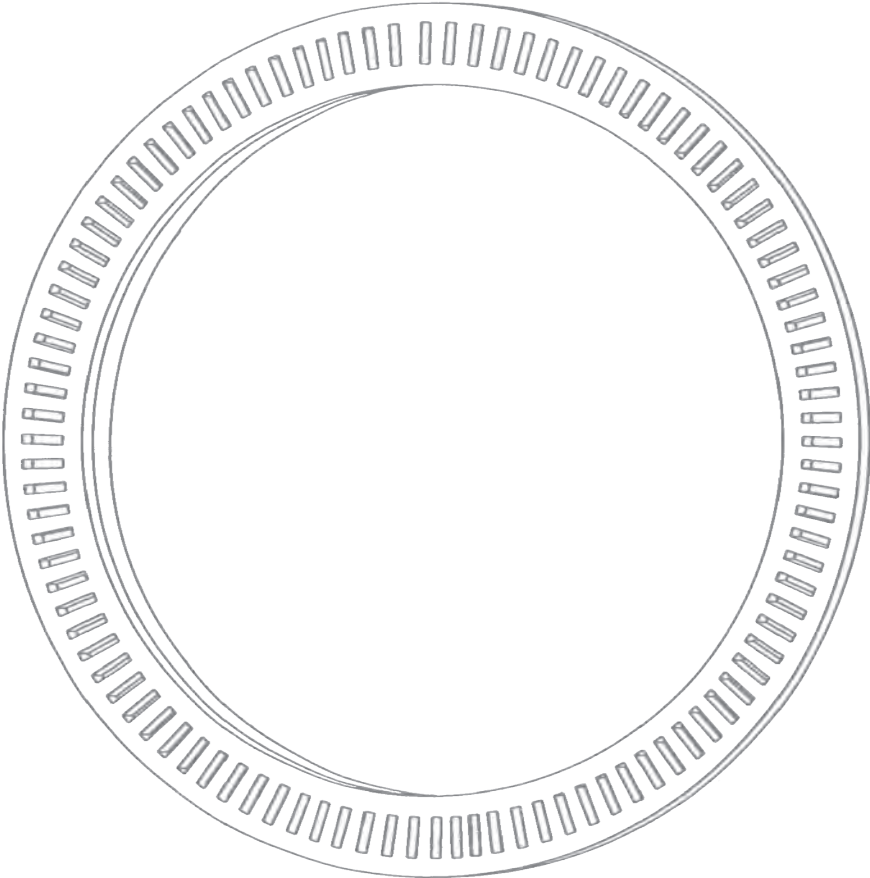

EXCITER RINGS

EXCITER RINGS - BPW

90.20.1000	
	
Teeth: 100 Inner Diameter: 125 mm Outer Diameter: 156 mm Height: 8.8 mm	
Alternatives	0331008510

90.20.1001	
	
Teeth: 80 Inner Diameter: 149.5 mm Outer Diameter: 176 mm Height: 19.5 mm	
Alternatives	0531008440 0531008441

90.20.1002	
	
Teeth = 100 Inner Diameter = 152 mm Outer Diameter = 170 mm Height = 15 mm	
Alternatives	03.310.08.15.0

90.20.1003	
	
Teeth: 100 Inner Diameter: 176 mm Outer Diameter: 194 mm Height: 15 mm	
Alternatives	03.310.08.14.0

90.20.1004	
	
Teeth = 100 Inner Diameter = 104.56 mm Outer Diameter = 166.44 mm Height = 18/21.87 mm	
Alternatives	05.310.07.30.1

90.20.1005	
	
Teeth = 80 Inner Diameter = 125 mm Outer Diameter = 156 mm Height = 8 mm	
Alternatives	03.310.08.53.0

90.20.1006	
	
Teeth = 100 Inner Diameter = 177 mm Outer Diameter = 215 mm Height = 22 mm	
Alternatives	03.310.09.39.0

	
Teeth = 100 Inner Diameter = 192 mm Outer Diameter = 220 mm Height = 21 mm	
Alternatives	03.310.09.34.0

90.20.1007	
	
Teeth = 80 Inner Diameter = 177 mm Outer Diameter = 215 mm Height = 22 mm	
Alternatives	0331009380

90.20.1008	
	
Teeth = 80 Inner Diameter = 152 mm Outer Diameter = 170 mm Height = 15 mm	
Alternatives	03.310.08.18.0

EXCITER RINGS - DAF

90.21.1000	
	
<p>Early XF Front Teeth: 100 Inner Diameter: 117.7 mm Outer Diameter: 148 mm Height: 13.5 mm</p>	
Alternatives	1391515 1805821

90.21.1001	
	
<p>Early XF Rear Teeth: 100 (Teeth Plate - Angled) Inner Diameter: 169 mm Outer Diameter: 222 mm Height: 18 mm</p>	
Alternatives	1391517 1805823

90.21.1002	
	
<p>Later XF Front Teeth: 100 Inner Diameter: 169 mm Outer Diameter: 212 mm Height: 18 mm</p>	
Alternatives	1657638 1805824

90.21.1003	
	
<p>Later XF Front Teeth: 100 Inner Diameter: 137.8 mm Outer Diameter: 168 mm Height: 13 mm</p>	
Alternatives	1391516 1805822

90.21.1004	
	
<p>Exciter Ring & Seal Teeth: 100 Inner Diameter: 125 mm Outer Diameter: 190 mm Height: 20 mm</p>	
Alternatives	1335063

90.21.1005	
	
<p>Exciter Ring & Seal Teeth: 100 Inner Diameter: 100 mm Outer Diameter: 166 mm Height: 22 mm</p>	
Alternatives	1334961

EXCITER RINGS - SAF

90.24.1000	
	
<p>Teeth: 100 Inner Diameter: 156 mm Outer Diameter: 195 mm Height: 11.5 mm</p>	
Alternatives	4029100101

90.24.1001	
	
<p>Teeth: 90 Inner Diameter: 116.5 mm Outer Diameter: 156 mm Height: 18.5 mm</p>	
Alternatives	4029106300

90.24.1002	
	
<p>Teeth: 80 Inner Diameter: 148.5 mm Outer Diameter: 184 mm Height: 11 mm</p>	
Alternatives	4029106900

90.24.1003	
	
<p>Teeth: 90 Inner Diameter: 150 mm Outer Diameter: 184 mm Height: 11 mm</p>	
Alternatives	4029107000

90.24.1004	
	
<p>Teeth: 90 Inner Diameter: 116.4 mm Outer Diameter: 161 mm Height: 20 mm</p>	
Alternatives	4029108100

90.24.1005	
	
<p>Teeth: 80 Inner Diameter: 156 mm Outer Diameter: 178 mm Height: 13 mm</p>	
Alternatives	204029106100

EXCITER RINGS - IVECO

90.25.1001	
	
Teeth = 80 Inner Diameter = Top at Teeth = 103 mm / Bottom = 110 mm Outer Diameter = 118 mm / Outer Bottom = 121 mm Height = 102 mm	
Alternatives	7172753

90.25.1002	
	
Teeth = 100 Inner Diameter = 130 mm Outer Diameter = 148 mm Height = 15 mm	
Alternatives	7172934

90.25.1003	
	
Teeth = 100 Inner Diameter = 202 mm Outer Diameter = 218 mm Height = 24 mm	
Alternatives	7166885

EXCITER RINGS - MAN

90.26.1000	
	
L2000 / LE Teeth: 80 Inner Diameter: 102 & 128 mm Outer Diameter: 131 & 162 mm Height: 80 mm	
Alternatives	81524030028

90.26.1001	
	
Teeth = 80 Inner Diameter = 114 mm Outer Diameter = 160 mm Height = 28 mm	
Alternatives	81524006005 81524030029 81930210397

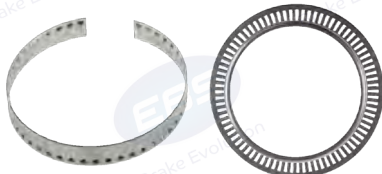
90.26.1001.K	
	
KIT EXCITER RING + SPACER	

90.26.1001.S	
	
EXCITER RING SPACER	

90.26.1002	
	
Teeth = 100 Inner Diameter (WITH RUNNER)=138 mm Outer Diameter = 205 mm Height (WITH RUNNER) = 17 mm	
Alternatives	8196503600

90.26.1003	
	
Teeth = 100 Inner Diameter = 135 mm Outer Diameter = 175 mm Height = 18 mm	
Alternatives	81965030398

EXCITER RINGS - MERCEDES

90.26.1000	
	
Atego Teeth: 80 Inner Diameter: 102 & 128 mm Outer Diameter: 131 & 162 mm Height: 80 mm	
Alternatives	9703560415

90.27.1000	
	
Discos Axle Teeth: 80 Inner Diameter: 168 mm Outer Diameter: 188 mm Height: 12 mm	
Alternatives	9463340115

90.27.1001	
	
Rear Axle - Left & Right Hand Teeth: 57 Inner Diameter: 102 & 117 mm Outer Diameter: 131 & 142 mm Height: 75 mm	
Alternatives	6683560515

EXCITER RINGS - MERCEDES

90.27.1002	
	
<p>Axor Rear Axle - Left & Right Hand Teeth: 100 Inner Diameter: 168 mm Outer Diameter: 202 mm Height: 12.5 mm</p>	
Alternatives	9463340015 9463340615

90.27.1003	
	
<p>Mercedes Rear Axle - Left & Right Hand Teeth: 90 Inner Diameter: 151 mm Outer Diameter: 179 mm Height: 11.9 mm</p>	
Alternatives	9463340515

90.27.1004	
	
<p>Teeth: 80 Inner Diameter: 134 mm Outer Diameter: 138 mm Height: 16 mm</p>	
Alternatives	9723340115

90.27.1005	
	
<p>Exciter Ring To Suit Mercedes Teeth: 100 Inner Diameter: 153 mm Outer Diameter: 195 mm Height: 16.5 mm</p>	
Alternatives	9423560015 9423560315 9423560715

90.27.1006	
	
<p>Teeth: 100 Inner Diameter: 160 mm Outer Diameter: 188 mm Height: 12 mm</p>	
Alternatives	9423340115

90.27.1007	
	
<p>Teeth: 80 Inner Diameter: 140 mm Outer Diameter: 175 mm Height: 19 mm</p>	
Alternatives	9763560015

90.27.1008	
	
<p>Teeth: 80 Inner Diameter: 144 mm Outer Diameter: 177 mm Height: 11.7 mm</p>	
Alternatives	9753340415

90.27.1009	
	
<p>Discos Axle Teeth: 80 Inner Diameter: 147 mm Outer Diameter: 200 mm Height: 14 mm</p>	
Alternatives	9733561015

90.27.1010	
	
<p>Teeth: 80 Inner Diameter: 127 mm Outer Diameter: 162 mm Height: 72 mm</p>	
Alternatives	9703560615

90.27.1011	
	
<p>Teeth: 100 Inner Diameter: 140 mm Outer Diameter: 178 mm Height: 15 mm</p>	
Alternatives	9433340115

90.27.10000	
	
<p>Inner Diameter: 166 mm Outer Diameter: 174 mm Height: 22 mm</p>	
Alternatives	9453340351

EXCITER RINGS

EXCITER RINGS - RENAULT

90.28.1000	
	
Teeth: 100 Inner Diameter: 129 mm Outer Diameter: 179 mm Height: 23 mm	
Alternatives	501031989

EXCITER RINGS - MERITOR (ROR)

90.36.1000	
	
Teeth: 80 Inner Diameter: 159 mm Outer Diameter: 173 mm Height: 15 mm	
Alternatives	21213033

90.36.1001	
	
Teeth: 100 Inner Diameter: 165 mm Outer Diameter: 179 mm Height: 15 mm	
Alternatives	21213316

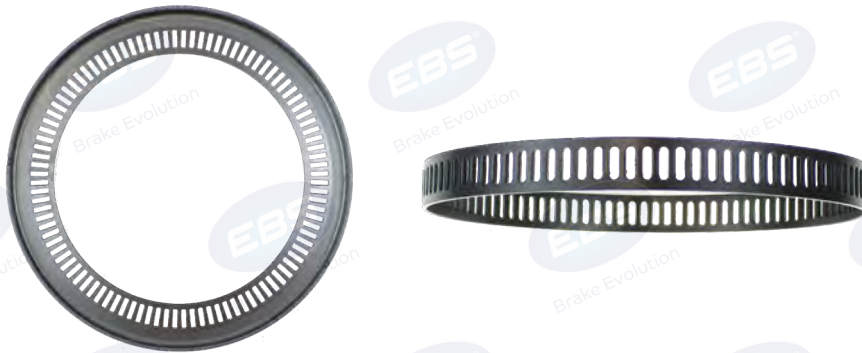

EXCITER RINGS - SCANIA

90.29.1000	
	
Teeth: 100 Inner Diameter: 126 mm Outer Diameter: 164 mm Height: 8.5 mm	
Alternatives	1339680 1375382

90.29.1001	
	
Teeth: 100 Inner Diameter: 126 mm Outer Diameter: 170 mm Height: 8.5 mm	
Alternatives	1442300

90.29.1002	
	
Teeth: 100 (Teeth Plate - Flat) Inner Diameter: 172.5 mm Outer Diameter: 188.5 mm Height: 21 mm	
Alternatives	1349016

90.29.1003	
	
Teeth: 100 (Teeth Plate - Angled) Inner Diameter: 172.5 mm Outer Diameter: 188.5 mm Height: 20 mm	
Alternatives	1442296

90.29.1004	
	
Teeth: 100 (Teeth Plate - Angled) Inner Diameter: 171.5 mm Outer Diameter: 189 mm Height: 13 mm	
Alternatives	1790708

90.29.1005	
	
Teeth: 100 (Teeth Plate - Angled) Inner Diameter: 135mm Outer Diameter: 186mm Height: 9.5 mm	
Alternatives	2223488

EXCITER RINGS - VOLVO

90.30.1000	
	
FH / FM Front Teeth: 100 Inner Diameter: 140 mm Outer Diameter: 164 mm Height: 7 mm	
Alternatives	20424109

90.30.1001	
	
FH / FM Front & Mid-Lift Teeth: 100 Inner Diameter: 132.2 mm Outer Diameter: 145.5 mm Height: 11.9 mm	
Alternatives	20392016

90.30.1002	
	
FH / FM Rear Teeth: 100 Inner Diameter: 167 mm Outer Diameter: 170 mm Height: 16 mm	
Alternatives	8156339

90.30.1003	
	
FH / FM Rear Teeth: 100 Inner Diameter: 154 mm Outer Diameter: 158 mm Height: 16 mm	
Alternatives	1075889

90.30.1004	
	
Teeth: 100 Inner Diameter: 165 mm Outer Diameter: 185 mm Height: 7 mm	
Alternatives	1076760

90.30.1005						
						
Alternatives		---				
	2:	3:	4:	5:	6:	7:
	Inner Diameter:	Inner Diameter:	Inner Diameter:	Inner Diameter:	Inner Diameter:	Inner Diameter:
	131.7 mm	106 mm	109 mm	113 mm	155 mm	160 mm
	Outer Diameter:	Outer Diameter:	Outer Diameter:	Outer Diameter:	Outer Diameter:	Outer Diameter:
	172 mm	135 mm	120.2 mm	117 mm	161 mm	130 mm
	Height:	Height:	Height:	Height:	Height:	Height:
	14.5 mm	2 mm	5.7 mm	8 mm	3 mm	10 mm

90.30.1006	
	
FH / FM Front Teeth: 100 Inner Diameter: 135 mm Outer Diameter: 164 mm Height: 11 mm	
Alternatives	22537018

90.30.1007	
	
FH / FM Front Teeth: 100 Inner Diameter: 133 mm Outer Diameter: 166.5 mm Height: 31 mm	
Alternatives	21210537

EXCITER RINGS

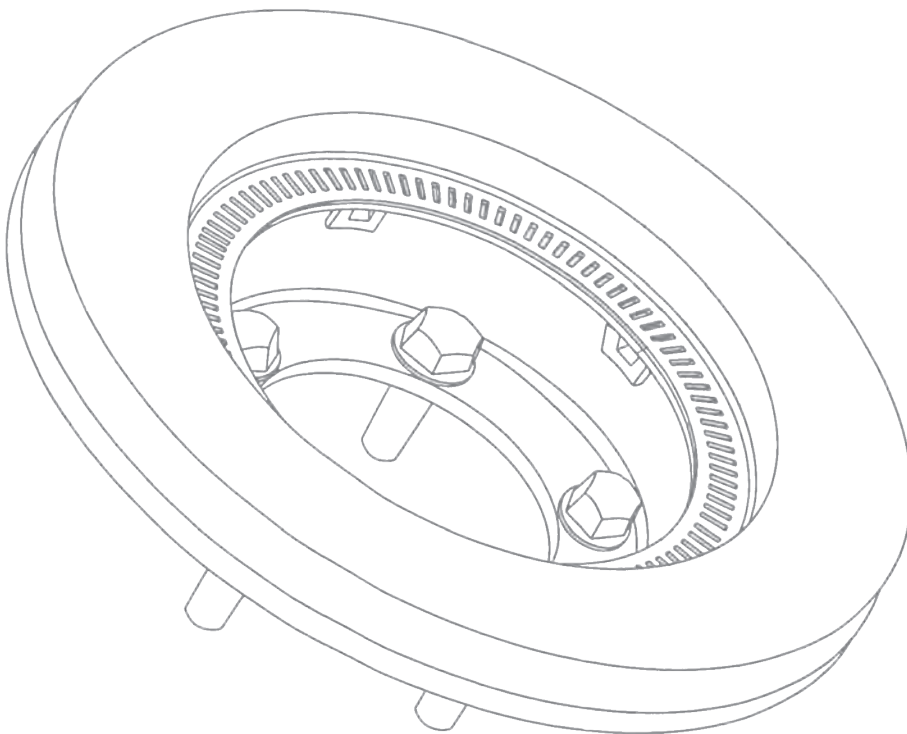

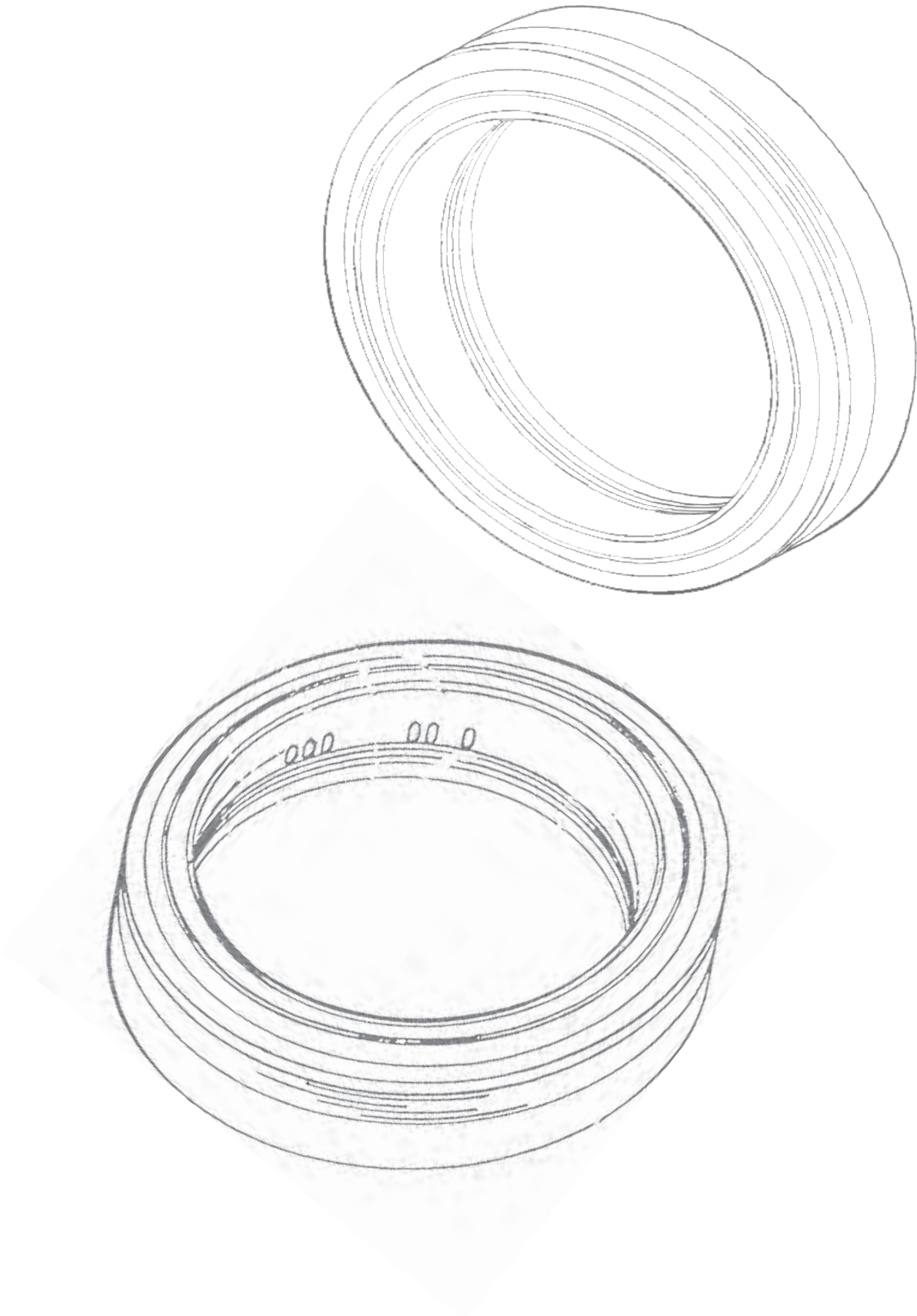

OIL SEALS

OIL SEALS - DAF

EKOS.32		EKOS.207		EKOS.208		EKOS.210	
80x130.2x12		100x124x12		100x140x15		114x142x14	
SEAL		SEAL		SEAL		SEAL	
Alternative Part No	69294	Alternative Part No	281986 1275084 1340321	Alternative Part No	1238034	Alternative Part No	190069
EKOS.215		EKOS.217					
125x160x14/17		100x124x12					
SEAL		SEAL					
Alternative Part No	292766	Alternative Part No	682961 1275083 1340320 1370127				

OIL SEALS - MAN

EKOS.15	
110x140x12	
SEAL	
Alternative Part No	81965020208

OIL SEALS - MERCEDES

EKOS.239		EKAOS.8	
120x150x15			
SEAL		SEAL	
Alternative Part No	0029971847 0049971747 0049971847 0109977347	Alternative Part No	6243560080 6503560080

OIL SEALS - RENAULT

EKOS.10	
80x100x10	
SEAL	
Alternative Part No	7700743161 7700854841

OIL SEALS - SCANIA

EKOS.15	
110x140x12	
SEAL	
Alternative Part No	300278

EKOS.57	
80x100x10	
SEAL	
Alternative Part No	304552

EKOS.75	
130x160x15	
SEAL	
Alternative Part No	231938 366303 369478

OIL SEALS - VOLVO

EKOS.9		EKOS.10		EKOS.15		EKOS.25	
80x100x10		130x160x15		110x140x12		168x188x30	
SEAL		SEAL		SEAL		SEAL	
Alternative Part No	267268 943044 943703	Alternative Part No	7700743161 7700854841	Alternative Part No	300278 1089552 1587792	Alternative Part No	1591903 1610765
EKOS.32		EKOS.36		EKOS.47		EKOS.48	
80x130.2x12		50x65x8		125x1148.3x8.1		29x50x10	
SEAL		SEAL		SEAL		SEAL	
Alternative Part No	1522895	Alternative Part No	1522373	Alternative Part No	Alternative Part No	424580

OIL SEALS

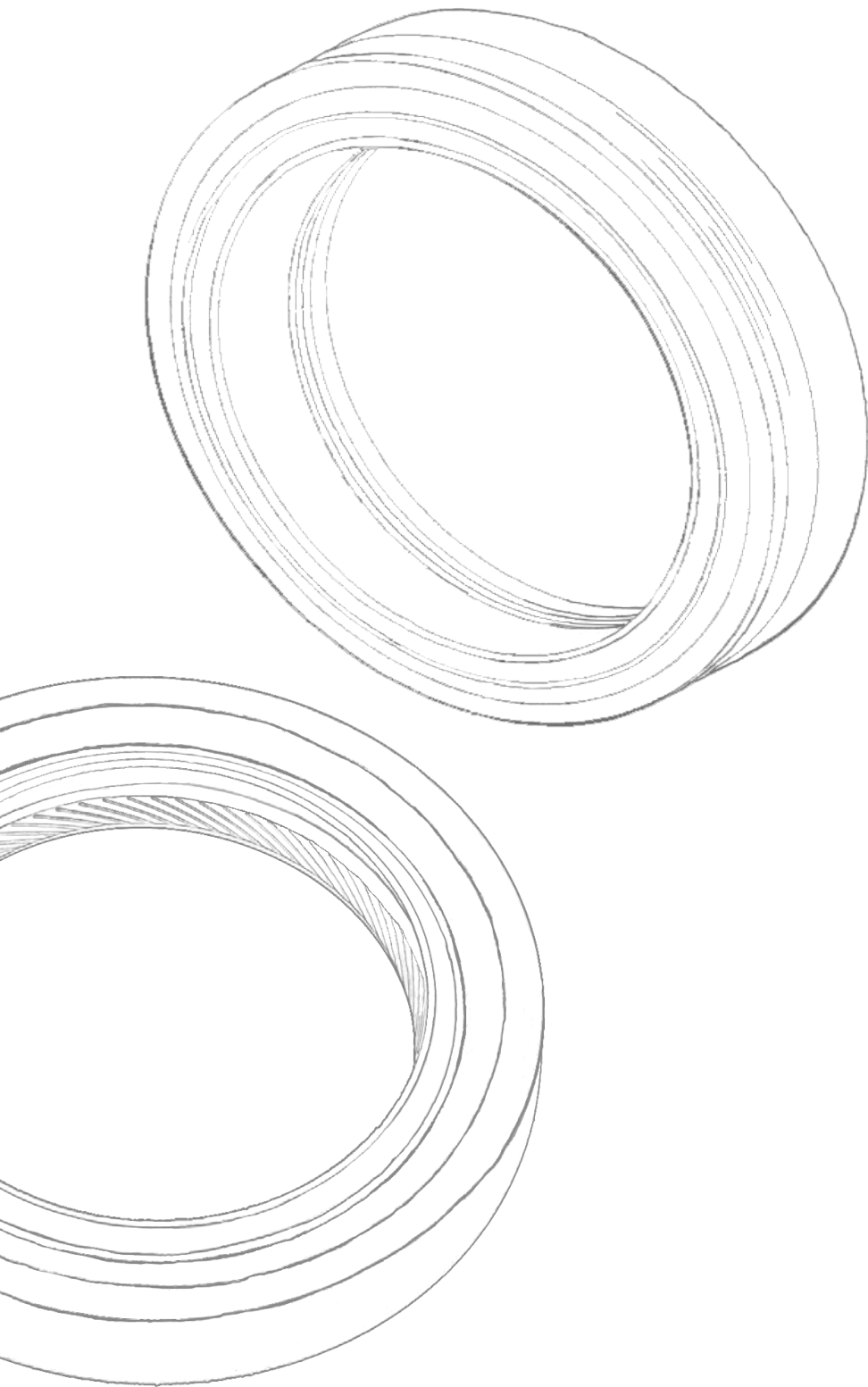





WHEEL HUBS

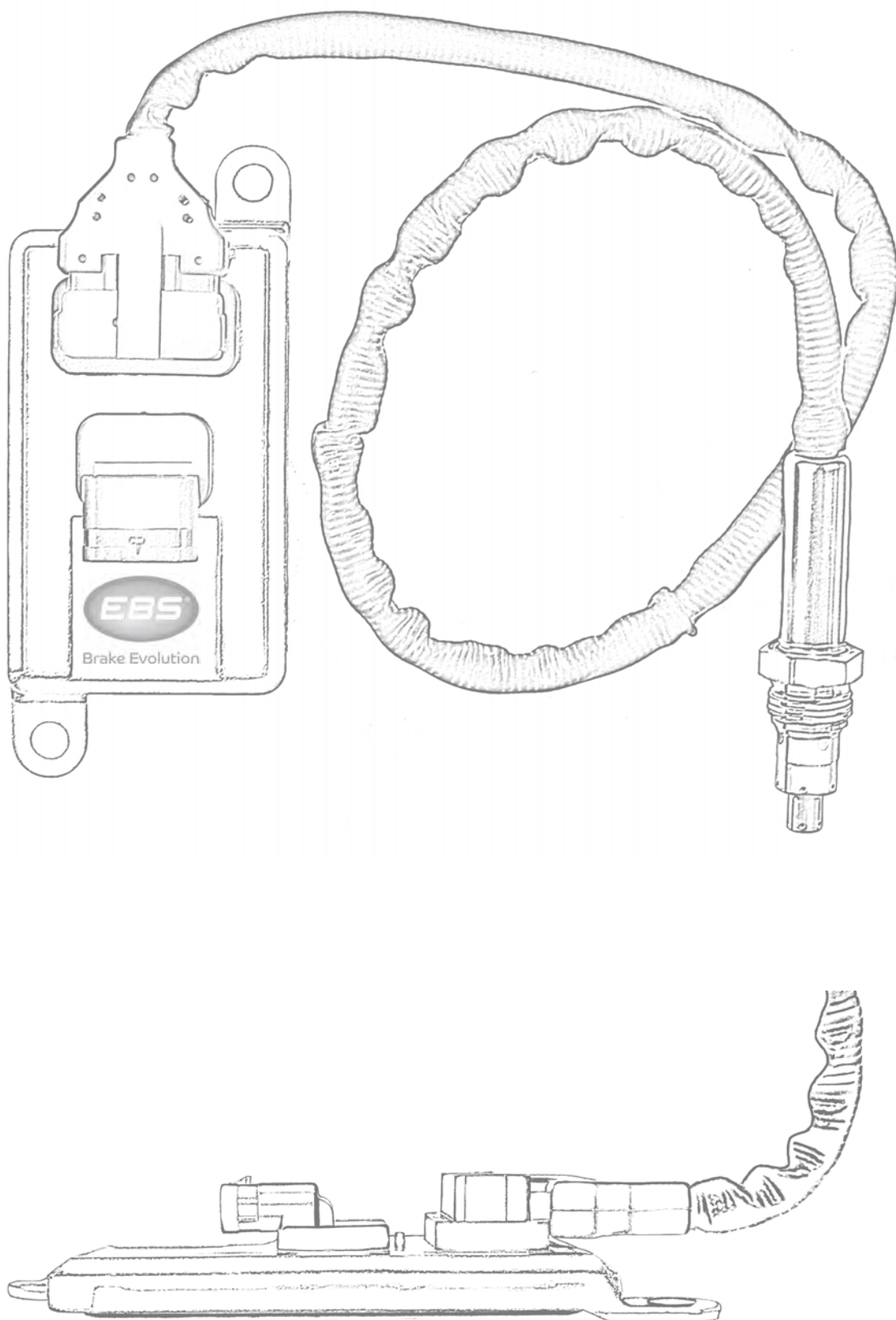



SELECTIVE CATALYTIC REDUCTION

NOX SENSORS

EBS Part No	Alternative	Application	Engine Type	Position	Cable Length	Image
30.38.1019	2872298	CUMMINS	EURO 5	AFTER CAT	890 mm	
30.38.1022	4326862	CUMMINS	EURO 6	AFTER CAT	590 mm	
30.38.1034	4326864	CUMMINS	EURO 5	AFTER CAT	590 mm	
30.38.1004	2011648 1836059 1793378	DAF	EURO 5	AFTER CAT	590 mm	
30.38.1005	2011649 1836060	DAF	EURO 5	BEFORE CAT	890 mm	
30.38.1008	1836061	DAF	EURO 5	AFTER CAT	890 mm	
30.38.1010	1705572	DAF	EURO 5	AFTER CAT	590 mm	
30.38.1023	2006245	DAF	EURO 6	BEFORE CAT	590 mm	
30.38.1028	2139930	DAF	EURO 6	AFTER CAT	890 mm	
30.38.1036	2006243	DAF	EURO 6	BEFORE CAT	695 mm	

NOX SENSORS						
EBS Part No	Alternative	Application	Engine Type	Position	Cable Length	Image
30.38.1039	1710806	DAF	EURO 6	AFTER CAT	890 mm	
30.38.1040	1952565	DAF	EURO 6	BEFORE CAT	890 mm	
30.38.1041	2236406	DAF	EURO 6	BEFORE CAT	690 mm	
30.38.1042	2236408	DAF	EURO 6	BEFORE CAT	545 mm	
30.38.1043	2293964	DAF	EURO 6	BEFORE CAT	745 mm	
30.38.1044	2293965	DAF	EURO 6	BEFORE CAT	545 mm	
30.38.1006	5801754015 5801424181	IVECO	EURO 5	BEFORE CAT	590 mm	
30.38.1007	5801754016 5801273980 5801443021	IVECO	EURO 5	AFTER CAT	890 mm	
30.38.1026	5801754014	IVECO	EURO 6	BEFORE CAT	890 mm	
30.38.1027	5801777219	IVECO	EURO 6	AFTER CAT	890 mm	

SELECTIVE CATALYTIC REDUCTION







NOX SENSORS







EBS Part No	Alternative	Application	Engine Type	Position	Cable Length	Image
30.38.1029	5801363754	IVECO	EURO 5	BEFORE CAT	590 mm	
30.38.1002	51154080015 51154080004 51154080009	MAN	EURO 5	BEFORE CAT	590 mm	
30.38.1009	51154080019	MAN	EURO 6	BEFORE CAT	590 mm	
30.38.1024	51.15408.0017	MAN	EURO 6	BEFORE CAT	890 mm	
30.38.1025	51.15408.0018	MAN	EURO 6	AFTER CAT	450 mm	
30.38.1035	51.15408.0016	MAN	EURO 6	AFTER CAT	890 mm	
30.38.1003	A0091533628	MERCEDES	EURO 5	BEFORE CAT	590 mm	
30.38.1016	A0101539528	MERCEDES	EURO 6	AFTER CAT	590 mm	
30.38.1017	A0101539628	MERCEDES	EURO 6	AFTER CAT	890 mm	
30.38.1018	A0101539328	MERCEDES	EURO 6	BEFORE CAT	590 mm	

NOX SENSORS						
EBS Part No	Alternative	Application	Engine Type	Position	Cable Length	Image
30.38.1021	A0081539928	MERCEDES	EURO 6	BEFORE CAT	890 mm	
30.38.1030	A0101531428	MERCEDES	EURO 6	BEFORE CAT	590 mm	
30.38.1031	A0101531728	MERCEDES	EURO 5	AFTER CAT	890 mm	
30.38.1032	A0101531628	MERCEDES	---	AFTER CAT	590 mm	
30.38.1033	A0101531528	MERCEDES	EURO 6	BEFORE CAT	890 mm	
30.38.2001	A0009050008	MERCEDES	SPRINTER, VITO	AFTER CAT	390 mm	
30.38.2002	A0009053109	MERCEDES	SPRINTER	BEFORE CAT	590 mm	
30.38.2003	A0009053503	MERCEDES	SPRINTER	BEFORE CAT	590 mm	
30.38.2004	A0009053403	MERCEDES	SPRINTER, VITO	BEFORE CAT	390 mm	
30.38.2005	A0009053009	MERCEDES	SPRINTER	AFTER CAT	390 mm	

SELECTIVE CATALYTIC REDUCTION



NOX SENSORS

EBS Part No	Alternative	Application	Engine Type	Position	Cable Length	Image
30.38.2006	A0009053603	MERCEDES	SPRINTER, VITO	AFTER CAT	790 mm	
30.38.2007	A0009050108	MERCEDES	VITO	AFTER CAT	590 mm	
30.38.2008	A0009058511	MERCEDES	LCV	---	590 mm	
30.38.10000	A0101531928	MERCEDES	---	---	445 mm	
30.38.10001	A0101538128	MERCEDES	---	---	445 mm	
30.38.2009	227908539R	RENAULT	MASTER VAN	---	890 mm	
30.38.2010	227905433R	RENAULT	MASTER VAN	---	590 mm	
30.38.10000	2296799 1782596 1872086 1908536 2020691 2247379	SCANIA	EURO 5	AFTER CAT	890 mm	
30.38.1014	2294290	SCANIA	EURO 6	BEFORE CAT	890 mm	
30.38.1015	2294291	SCANIA	EURO 6	AFTER CAT	890 mm	

NOX SENSORS						
EBS Part No	Alternative	Application	Engine Type	Position	Cable Length	Image
30.38.1037	2296798	SCANIA	EURO 5	BEFORE CAT	890 mm	
30.38.1001	22827993 20873117 20873395 22219283	VOLVO	EURO 5	AFTER CAT	590 mm	
30.38.1011	21567737	VOLVO	EURO 5	BEFORE CAT	590 mm	
30.38.1012	21636091	VOLVO	---	---	590 mm	
30.38.1013	22303391	VOLVO	---	---	590 mm	
30.38.1020	22827995 7422827995 22219284 7422219284	VOLVO	EURO 6	AFTER CAT	890 mm	
30.38.1038	22827992	VOLVO	EURO 6	BEFORE CAT	890 mm	

SELECTIVE CATALYTIC REDUCTION

AD-BLUE - DOSING INJECTORS - DAF & VOLVO

EBS Part No	Alternative	Application	Image
34.21.8001	1703574	DAF	
34.30.7002	22391563	VOLVO	

AD-BLUE - DOSING PUMPS

EBS Part No	Alternative	Application	Image
34.21.9001	1409391	DAF	
34.21.9002	2871880	DAF	
34.27.9001	A0001404478	MERCEDES	
R34.29.9001	2655852	SCANIA	
R34.29.9002	2722701	SCANIA	
34.30.9002	22851845	VOLVO	
34.30.9003	21332695	VOLVO	
R34.30.9001	22209517	VOLVO	

AD-BLUE - METERING DEVICE

EBS Part No	Alternative	Application	Image
34.27.6001	A0001404139	MERCEDES	

AD-BLUE - DOSING MODULES

EBS Part No	Alternative	Application	Image
34.21.7001	1819790	DAF	
34.21.7002	1952532 1819798	DAF	
34.21.7003	1975291	DAF	
34.25.7001	504365576	IVECO	
34.25.7002	504374327	IVECO	
34.25.10000	41271148	IVECO	
34.28.7001	7421234246	RENAULT	
34.28.7002	7420766868	RENAULT	
34.29.7001	1753208	SCANIA	
34.30.7001	21738132	VOLVO	

SELECTIVE CATALYTIC REDUCTION

AD-BLUE - SOLENOID VALVES - VOLVO

EBS Part No	Alternative	Application	Image
34.30.1000	20933795	VOLVO	
34.30.1001	21314741	VOLVO	
34.30.1002	21314742	VOLVO	

AD-BLUE - LEVEL SENSORS

EBS Part No	Alternative	Application	Image
34.27.5001	A0145428717	MERCEDES	

CATALYST SENSOR

EBS Part No	Alternative	Application	Image
34.21.5001	1927179	DAF	

AD-BLUE - PRESSURE SENSORS

EBS Part No	Alternative	Application	Image
30.27.2032	A0061537428	MERCEDES	
30.27.2033	A0061537528	MERCEDES	

AD-BLUE TEMPERATURE SENSORS

EBS Part No	Alternative	Application	Image
30.27.2031	A0061534528	MERCEDES	

AD-BLUE UREA FILTERS

EBS Part No	Alternative	Application	Image
34.27.4000	A0001420289	MERCEDES	
34.29.4000	2265673	SCANIA	
34.30.4000	21516229	VOLVO	
34.30.4001	20713630	VOLVO	
34.30.4002	20877958	VOLVO	
34.30.4003	21333097	VOLVO	

AD-BLUE UREA HEATER

EBS Part No	Alternative	Application	Image
34.30.2000	21734245	VOLVO	

SELECTIVE CATALYTIC REDUCTION

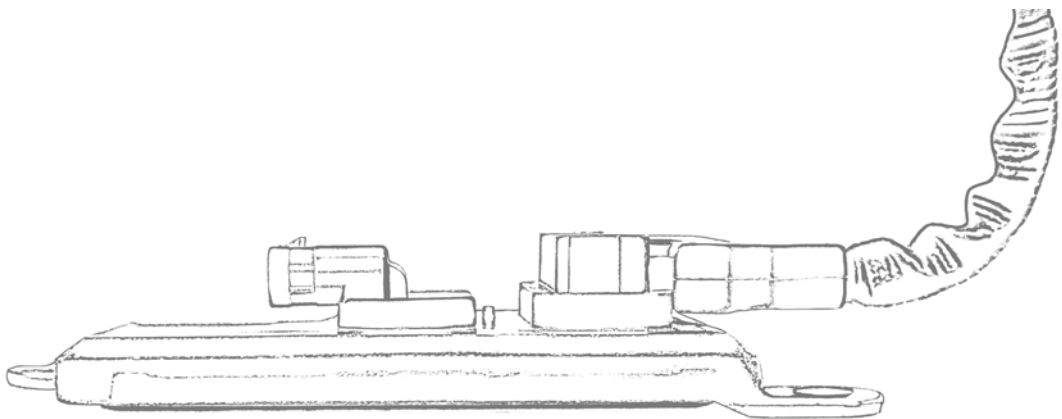
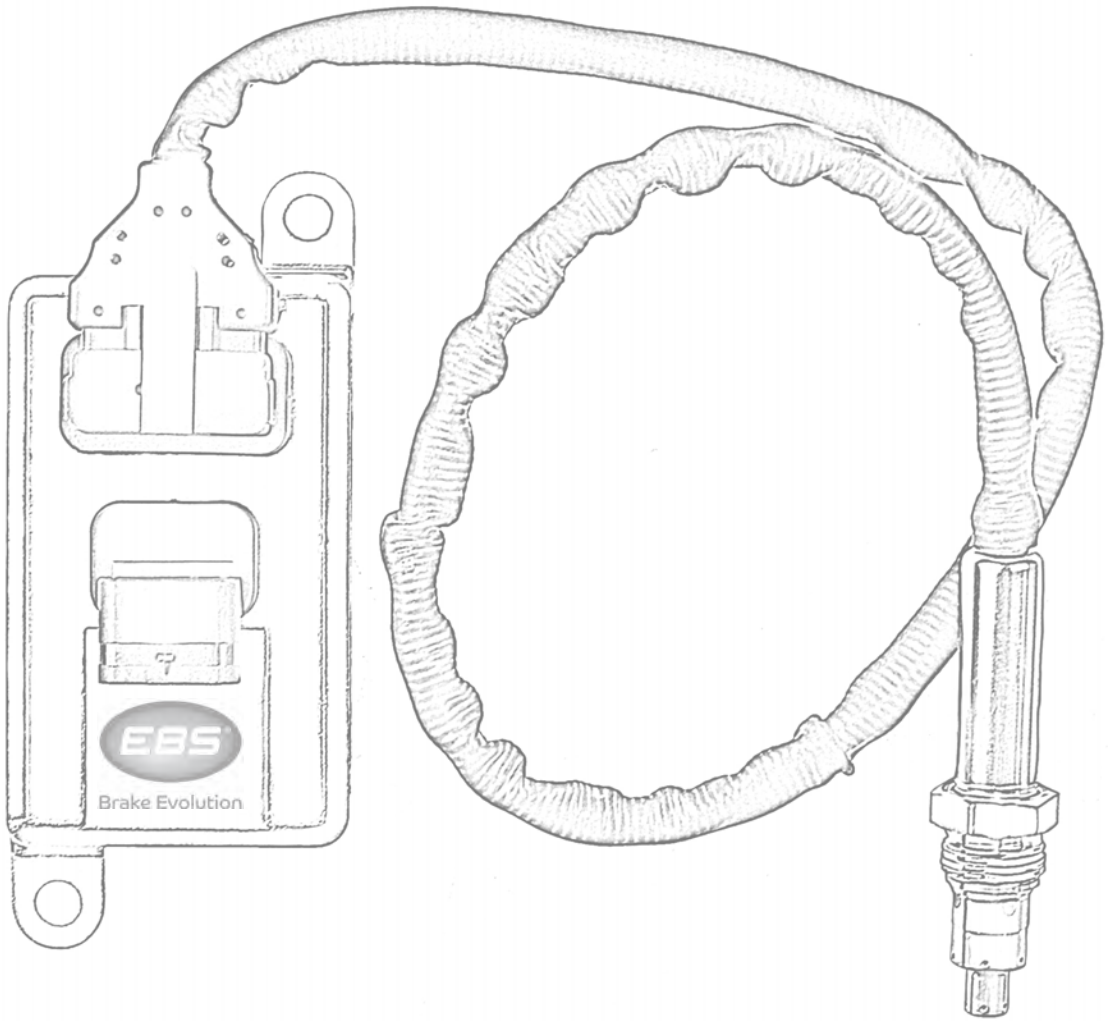

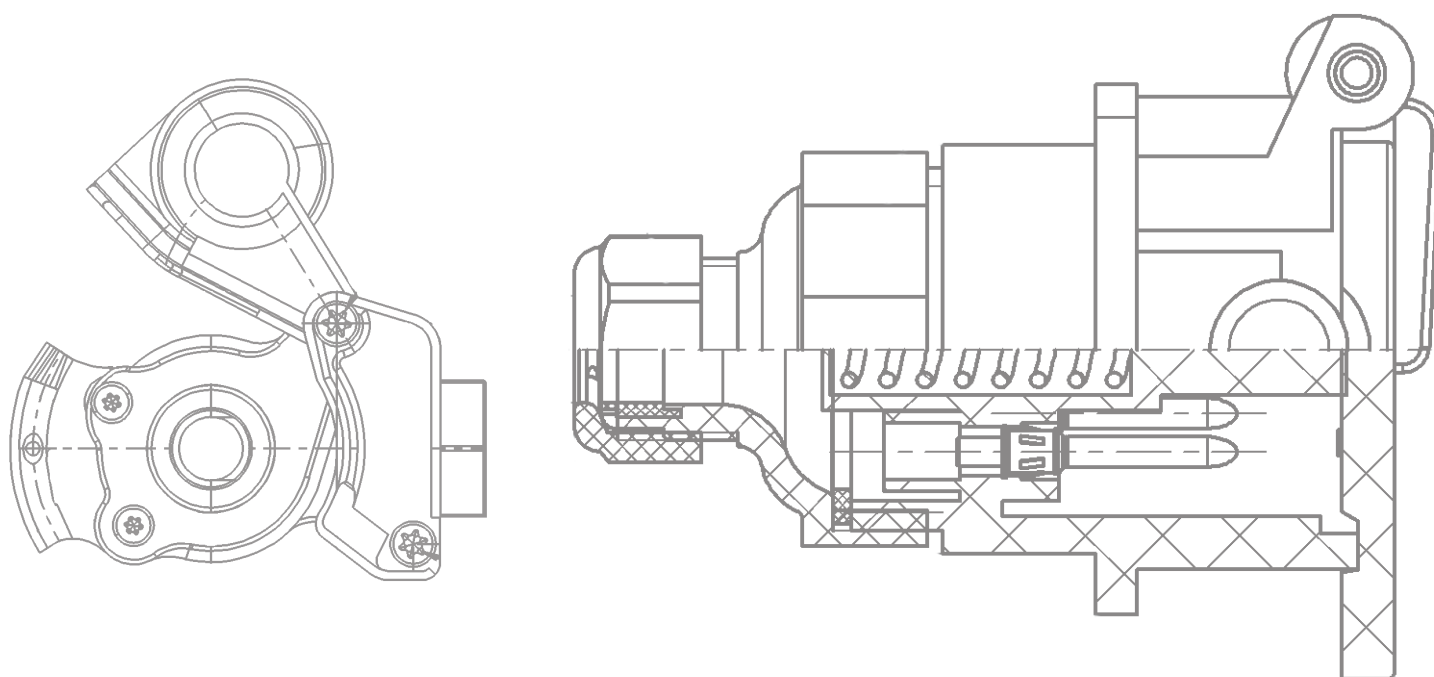
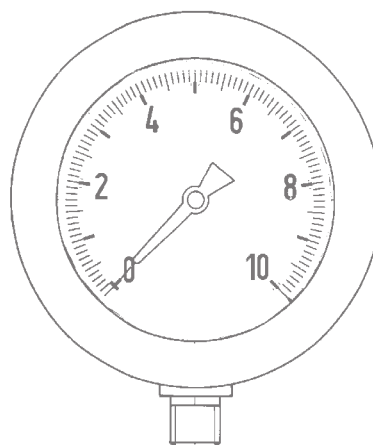
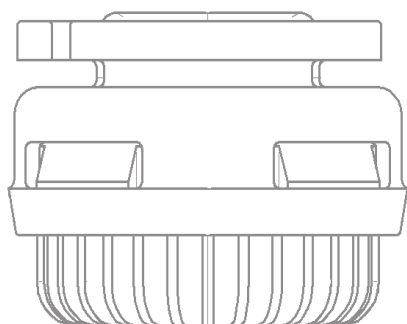
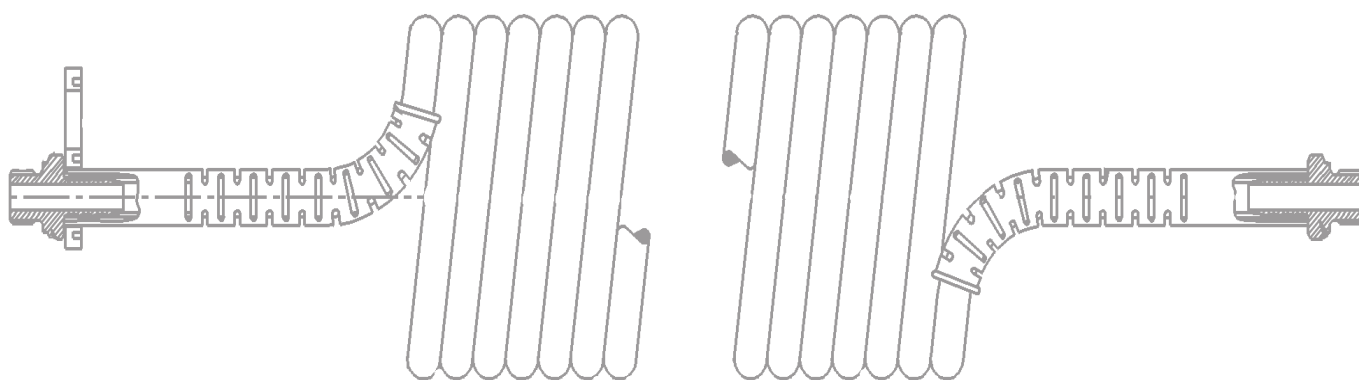

AIR COILS

90.01.4000		90.01.4001		90.01.4002		90.01.4003	
Alternative Part No	4527110040	Alternative Part No	4527110050	Alternative Part No	4527110060	Alternative Part No	4527110070
Air Coil - Red 22 Turn M22 x 1.5		Air Coil - Yellow 22 Turn M22 x 1.5		Air Coil - Red 22 Turn M16x1.5		Air Coil - Yellow 22 Turn M16x1.5	
90.01.4004		90.01.4005					
Alternative Part No	4527110080	Alternative Part No	4527110090				
Air Coil Black - Red Ends 22 Turn M16x1.5 / M18x1.5		Air Coil Black - Yellow Ends 22 Turn M16x1.5 / M18x1.5					

PALM COUPLINGS

90.02.1001		90.02.1002		90.02.1003		90.02.1004	
Alternative Part No	---	Alternative Part No	4522000110	Alternative Part No	4522000120	Alternative Part No	9522000220
M22 No Cap		Red Cap M22		Yellow Cap M22		Yellow Cap M16	
90.02.1005		90.02.1006		90.02.1007		90.02.1008	
Alternative Part No	9522000210	Alternative Part No	9522002210	Alternative Part No	9522002220	Alternative Part No	4522002110
Red Cap M16		Red Cap M16 Self Sealing		Yellow Cap M16 Self Sealing		Red Cap M22 Self Sealing	

PALM COUPLINGS

<p>90.02.1009</p>  <p>Alternative Part No 4522002120</p> <p>Yellow Cap M22 Self Sealing</p>	<p>90.02.1011</p>  <p>Alternative Part No 4522000040</p> <p>Black Cap M22</p>	<p>90.02.2000</p>  <p>Alternative Part No 9522010010</p> <p>Yellow Cap M16 & M24 bulkhead With Filter</p>	<p>90.02.2001</p>  <p>Alternative Part No 9522010020</p> <p>Red Cap M16 & M24 bulkhead With Filter</p>
<p>90.02.2002</p>  <p>Alternative Part No 9522010030</p> <p>Yellow Cap M16 With Filter</p>	<p>90.02.2003</p>  <p>Alternative Part No 9522010040</p> <p>Red Cap M16 With Filter</p>	<p>90.02.2004</p>  <p>Alternative Part No 9522010070</p> <p>Yellow Cap M16 With Filter & Test Connection</p>	<p>90.02.2005</p>  <p>Alternative Part No 9522010080</p> <p>Yellow Cap M16 & M24 bulkhead With Filter & Test Connection</p>

COUPLINGS

<p>90.01.1000</p>  <p>Alternative Part No 4528060000</p> <p>Triple Coupling Truck Application</p>	<p>90.01.1002</p>  <p>Alternative Part No 4528080020</p> <p>Triple Coupling Truck Application</p>	<p>90.01.1004</p>  <p>Alternative Part No 4528050040</p> <p>Duomatic Coupling Truck Application</p>	<p>90.01.1005</p>  <p>Alternative Part No 4528030050</p> <p>Duomatic Coupling Trailer Application</p>
<p>90.01.1009</p>  <p>Alternative Part No 4528020070</p> <p>Duomatic Coupling Truck Application</p>	<p>90.01.1012</p>  <p>Alternative Part No 4528040120</p> <p>Duomatic Coupling Trailer Application</p>		

Please Note: 90.01.1009 matches up with 90.01.1012. • Please Note: 90.01.1005 matches up with 90.01.1004.

SHUT-OFF COCKS

90.01.3003		90.01.3107		90.01.3132		90.01.3133	
Alternative Part No	4630790030	Alternative Part No	4520021070	Alternative Part No	94520021320	Alternative Part No	4520021330
4/2 Way Cock		Shut-Off Cock Metal Handle		Shut-Off Cock Plastic Handle		Shut-Off Cock	

ELECTRICAL COILS - EBS / ABS

90.00.1000		01-241		01-252	
7 Core EBS Coil With Plugs (EBS BRAND)		7 Core EBS Coil With Plugs (M&K BRAND)		15 CORE COIL WITH PLUGS (M&K BRAND)	

ELECTRICAL COILS - "N" & "S" TYPE

90.00.1002		90.00.1003		01-230		01-233	
Normal 7 Core Coil Moulded Plugs (EBS BRAND)		Supplementary 7 Core Coil Moulded Plugs (EBS BRAND)		24Volt to 12Volt 7 Core Coil 16 Turn Metal Plugs (EBS BRAND)		Normal 7 Core Coil 16 Turn Metal Plugs (EBS BRAND)	

ELECTRICAL COILS - "N" & "S" TYPE

<p>01-234</p> 	<p>01-238</p> 	<p>01-239</p> 	<p>01-629</p> 
<p>Supplementary 7 Core Coil 16 Turn Metal Plugs (EBS BRAND)</p>	<p>Normal 7 Core Coil Moulded Plugs (M&K BRAND)</p>	<p>Supplementary 7 Core Coil Moulded Plugs (M&K BRAND)</p>	<p>Supplementary 7 Core Coil 16 Turn Metal Plugs (EBS BRAND)</p>
<p>01-891</p> 	<p>01-892</p> 	<p>01-893</p> 	<p>01-894</p> 
<p>Normal 7 Core Coil 22 Turn Metal Plugs (EBS BRAND)</p>	<p>Supplementary 7 Core Coil 22 Turn Metal Plugs (EBS BRAND)</p>	<p>Normal 7 Core Coil 22 Turn Plastic Plugs (EBS BRAND)</p>	<p>Supplementary 7 Core Coil 22 Turn Plastic Plugs (EBS BRAND)</p>

ELECTRICAL COILS - TWIN (ADAPTOR) TYPE

<p>90.00.1001</p> 	<p>01-245</p> 	<p>01-246</p> 	<p>01-247</p> 
<p>15 Pin To 2 X 7 Core Standard Type (EBS BRAND)</p>	<p>15 Pin To 2 X 7 Core To Suit RENAULT (M&K BRAND)</p>	<p>15 Pin To 2 X 7 Core To Suit SCANIA R SERIES (M&K BRAND)</p>	<p>15 Pin To 2 X 7 Core To Suit MAN (M&K BRAND)</p>
<p>01-248</p> 	<p>01-249</p> 	<p>01-250</p> 	
<p>15 Pin To 2 X 7 Core To Suit MERCEDES (M&K BRAND)</p>	<p>15 Pin To 2 X 7 Core To Suit IVECO (M&K BRAND)</p>	<p>15 Pin To 2 X 7 Core Standard Type (M&K BRAND)</p>	

ACCESSORIES



ELECTRICAL PLUGS

<p>01-007</p>  <p>Plug C/W Screw Ring</p>	<p>01-143</p>  <p>Normal 7 Pin Aluminium Plug Black Insert</p>	<p>01-144</p>  <p>Supplementary 7 Pin Aluminium Plug White Insert</p>	<p>01-145</p>  <p>Normal 7 Pin Plastic Plug Black Insert</p>
<p>01-147</p>  <p>Supplementary 7 Pin Plastic Plug White Insert</p>	<p>01-346</p>  <p>Normal 7 Pin Metal Plug 12 Volt</p>	<p>01-348</p>  <p>Normal 7 Pin Plastic Plug 12 Volt</p>	<p>01-551</p>  <p>Supplementary 7 Pin Plastic Plug 12 Volt</p>
<p>01-549</p>  <p>Supplementary 7 Pin Metal Plug 12 Volt</p>	<p>01-810</p>  <p>Normal 7 Pin Aluminium Plug Black Insert Spade Terminals</p>	<p>01-812</p>  <p>Supplementary 7 Pin Aluminium Plug White Insert Spade Terminals</p>	<p>01-950</p>  <p>EBS 7 Pin Plastic Plug Crimped Terminals</p>
<p>01-952</p>  <p>15 Pin Plastic Plug Crimped Terminals</p>	<p>01-954</p>  <p>ABS 5 Pin Plastic Plug Crimped Terminals</p>		

ELECTRICAL PLUGS

01-958	01-961	01-963	01-964
			
7 Pin Plastic Plug Screw Terminals	15 Pin Plastic Plug Screw Terminals	2 Pin Plug C/W Screw Ring	3 Pin Plug

ELECTRICAL SOCKETS

6.00887.000	6.00943.000
	
- Park Socket - Military Spec	- Socket Cover - Military Spec

ELECTRICAL SOCKETS

01-137	01-138	01-146	01-148
			
Normal 7 Pin Aluminium Socket	Supplementary 7 Pin Aluminium Socket	Normal 7 Pin Plastic Socket	Supplementary 7 Pin Plastic Socket
01-347	01-349	01-468	01-550
			
Normal 7 Pin Metal Socket 12Volt	Normal 7 Pin Plastic Socket 12Volt	Single Pin Metal Socket	Supplementary 7 Pin Metal Socket 12Volt

ELECTRICAL SOCKETS

<p>01-552</p>  <p>Supplementary 7 Pin Plastic Socket 12Volt</p>	<p>01-811</p>  <p>Normal 7 Pin Aluminium Socket Spade Terminals</p>	<p>01-813</p>  <p>Supplementary 7 Pin Aluminium Socket Spade Terminals</p>	<p>01-924</p>  <p>Y Adaptor Converts 15 Pin To 2 X 7 Core (M&K BRAND)</p>
<p>01-949</p>  <p>ABS 5 Pin Socket Crimped Terminals</p>	<p>01-951</p>  <p>ABS / EBS 7 Pin Socket Crimped Terminals</p>	<p>01-953</p>  <p>15 Pin Socket Crimped Terminals</p>	<p>01-955</p>  <p>ABS / EBS Parking Socket</p>
<p>01-956</p>  <p>ABS / EBS 7 Pin Socket Screw Terminals C/W Colour Coded Tabs For Easy Fitment (M&K BRAND)</p>	<p>01-957</p>  <p>Truck Starter Socket Wired To Truck As A Way Of Jump Starting A Truck</p>	<p>01-959</p>  <p>15 Pin Socket Screw Terminals (M&K BRAND)</p>	<p>01-965</p>  <p>7 PIN Plastic Socket 24v SCREW</p>
<p>01-969</p>  <p>Dummy Parking Socket Universal Type</p>			

SILENCERS

<p>90.01.2012</p>  <p>Alternative Part No 4324070120</p> <p>Snap-On Max 18.5 Bar</p>	<p>90.01.2015</p>  <p>Alternative Part No 4324070150</p> <p>Snap-On Max 13 Bar</p>	<p>90.01.2017</p>  <p>Alternative Part No 4324070170</p> <p>Snap-On Max 13 Bar</p>	<p>90.01.2018</p>  <p>Alternative Part No 4324070180</p> <p>Snap-On Max 13 Bar</p>
<p>90.01.2050</p>  <p>Alternative Part No 4324070500</p> <p>Snap-On Max 11 Bar</p>	<p>90.01.2060</p>  <p>Alternative Part No 4324070600</p> <p>22mm Screw-On Max 13 Bar</p>	<p>90.01.2070</p>  <p>Alternative Part No 4324070700</p> <p>Snap-On Max 10 Bar</p>	<p>90.01.2913</p>  <p>Alternative Part No 9325109132</p> <p>Snap-On Max 10 Bar</p>
<p>90.04.1000</p>  <p>Alternative Part No 0484210017000</p> <p>Snap-On Max 13 Bar</p>	<p>90.04.1001</p>  <p>Alternative Part No 0484210001000</p> <p>22mm Screw-On</p>	<p>4327000000</p>  <p>22mm Screw-On</p>	<p>EKMM.4.SIL</p>  <p>Repair Kit Silencer</p>

FOOT VALVE SILENCER -WABCO

<p>90.01.2202</p>  <p>Alternative Part No 4800015202</p>

ADJUSTMENT CONTROL VALVE

<p>90.30.2000</p>  <p>Alternative Part No 20748450</p>

COOLANT CONNECTING PIPE - VOLVO

<p>90.30.10000</p>  <p>Alternative Part No 20555313</p>
--

ACCESSORIES

DIAGNOSTIC & TEST EQUIPMENT - ABS / EBS SENSORS

POTENTIOMETER TESTING DEVICE DRA01



Potentiometer box will test all KNORR Potentiometers & WABCO MAXX 22.

POTENTIOMETER TESTING DEVICE (+EXTRA CABLES) DRA01.V1



As DRA01 but this has additional cables for VOLVO applications: 1xDRA01.1 and 1xDRA01.2

TRAILERMASTER DRA02HDL



Self-contained 24 Volt Power Box with power sockets (24N, 24S, and ISO 7638), voltmeter, switches and warning lamps to test the electrical functions on trailer sockets to the Power Box.

TRAILERMASTER DRA03



24 Volt Power Box with auto light to test trailers electrical system using 24N, 24S power sockets, and test the ABS warning lamp using the ISO 7638 socket.

ISOMASTER DRA07T



Triple ISO Tester For Truck's ISO 7638 Socket, Trailer Susie and ABS Functions

SENSORMASTER DRA08



Handheld Test Equipment For ABS / EBS Sensors & Exciter Rings

DIAGNOSTIC & TEST EQUIPMENT - HALDEX

814036001



PC To EBS EB+ Diagnostic Cable For Gen 3

6.5M Cable

814036011



PC To EBS EB+ Diagnostic Cable For Gen 3

15M Cable

814036021



PC To EBS EB+ Diagnostic Cable For Gen 3

20M Cable

815015001



Lining Wear Sensor Interface For EBS EB+

2M Cable

DIAGNOSTIC & TEST EQUIPMENT - HALDEX

815018001	815041001	950800486	950800909
			
<p>Head Board Interface EBS EB+ To Diag+/Info Centre 0.45M Cable</p>	<p>Info Centre 2 For EBS EB+</p>	<p>Diagnostic Cable Kit For EBS EB+</p>	<p>Interface Kit For EBS EB+</p>

DIAGNOSTIC & TEST EQUIPMENT - HALDEX

950800915

<p>Interface Kit for Gen 3</p>

DIAGNOSTIC & TEST EQUIPMENT - KNORR BREMSE

KB914

<p>Trailer Information Module (TIM)</p>

DIAGNOSTIC & TEST EQUIPMENT - WABCO

4006064100	4463003270	4463003292	4463004000
			
<p>Ultrasonic Leakage Detector</p>	<p>ABS / ECAS / EPS 35 Pin Diagnostic Cable</p>	<p>VCS / ECAS / VARIO C / TRAILER EBS Handheld Tester Diagnostic Cable 6M</p>	<p>VCS / VARIO C Handheld Tester</p>
4463004040	4463004080	4463004530	
			
<p>VARIO C Diagnostic Cable</p>	<p>ABS D Basic Diagnostic Cable</p>	<p>DAF EBS Euro / ECAS KWP K Diagnostic Cable</p>	

Please contact us if the Diagnostic Equipment you require is not listed within these pages.

DIAGNOSTIC & TEST EQUIPMENT - WABCO

90.444		4530040050		4530040070		90.06.3731	
20 Bar Pressure Gauge C/W Rubber Protection Housing (EBS Brand)		10 Bar Pressure Gauge C/W Rubber Protection Housing		16 Bar Pressure Gauge C/W Rubber Protection Housing		Test Connection (NKW3731/1)	
90.01.9000		90.01.9001	90.01.9002	90.01.9003		0116	
Alternative	SC1006	Test Hose - Black 6.5M M16 Thread	Test Hose - Black 2M M16 Thread	Test Hose Black 10M		Standard Air Brake Test Kit 1 Gauge	
Test Hose End Piece Kit M16 Thread							
90.222							
For a complete coverage of all Air Brake systems this kit is capable of testing Spring Brakes, Air Suspension LSV & adjusting unit plus many other combinations to suit all your needs.		Premium Air Brake Test Kit Includes: 3 x 6M Test Hoses 3 x 2M Test Hoses Test Points 4 x Gauges plus a range of couplings & fittings all housed in a compact carry case.					

VOLVO - FUEL FILTER

EBS6003F		EBS8367F		90.30.5000		90.30.5000.C	
Alternative	20976003	Alternative	20998367	Alternative	20873675	Alternative	---
Spin on Fuel Filter		Spin on Fuel Filter		Fuel Filter Housing		Fuel Filter Housing Complete	

EBS TEST BENCHES



Compressor Testing



EBS.BENCH.01

The ultimate Test Bench for any workshop facility. Able to isolate & detect pressure drops with each output individually controllable by the operator for the performance Testing Of:

- Air Compressors
- Brake Chambers
- Clutch Servos
- Multi Circuit Protection Valves
- Load Sensing Valves
- And Many More Pneumatic Valves.

4 x Inputs, 4 Outputs, Quick Release Couplings, 12 x High Quality 12 Bar Gauges all enclosed within a durable Powder Coated Casing that can be colour matched to any RAL colour code on request*

*Extra charge may apply



Clutch Servo Testing



Spring Brake Testing

ACCESSORIES

EBS TEST BENCHES

EBS.BENCH.02

This test bench is used mainly for testing performance of air compressor, master valve, air chamber, quick release valve and four-circuit valve, etc in brake system of various vehicles, and carrying out double-chamber or three-chamber test of master valve.

Air compressor
Master valve
Wheel cylinder
Quick release valve
Relay valve
Four-circuit valve
Differential valve

Working power: AC380V 50Hz
Motor power: 11KW
Frequency converter power: 11KW
Variable frequency speed regulating range:
No load 0-5000r/min
Load 0-2000r/min continuously adjustable
Volume of main air tank: 20L*2 or 20L*3
Auxiliary tank of air pump: 15L
External air source: 1Mpa
Air passing time: 0-99.999s
Rated pressure of oil pump:
0-1Mpa continuously adjustable
With over-load protection function, phase loss and short circuit protection function.



EBS.BENCH.03

This test bench is used mainly for testing performance of brake master cylinder, Spring brake chambers and air valves (quick release valve and relay valve, differential valve, four circuit valve, etc)

Power source: AC220V 50HZ
Input air source: 0-1.0Mpa
Tested pressure range: 0-1.0Mpa (adjustable)
Test precision grade: 31%
DC input: 12V 24V current: 5A



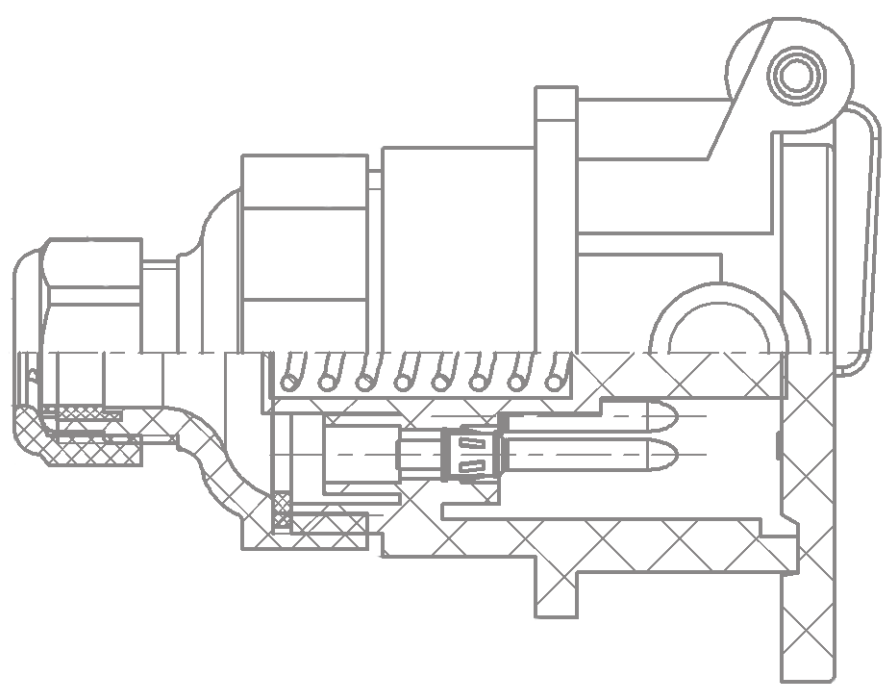

INDEX

EBS Reference	Page	EBS Reference	Page	EBS Reference	Page	EBS Reference	Page	EBS Reference	Page
01.01.1000	1.7	01.01.1735	1.8	01.01.A001	1.13	01.02.4113	1.4	01.02.4284	1.5
01.01.1005	1.7	01.01.1907	1.8	01.01.B000	1.13	01.02.4116	1.4	01.02.4286	1.5
01.01.1007	1.7	01.01.2000	1.8	01.01.B001	1.13	01.02.4117	1.4	01.02.4298	1.5
01.01.1010	1.7	01.01.2003	1.8	01.01.B002	1.13	01.02.4119	1.5	01.02.5700	1.6
01.01.1011	1.7	01.01.2004	1.8	01.01.C004	1.8	01.02.4124	1.4	01.02.5708	1.6
01.01.1020	1.7	01.01.2005	1.8	01.01.D168	1.8	01.02.4125	1.4	01.02.6000	1.6
01.01.1021	1.7	01.01.2006	1.8	01.01.E062	1.9	01.02.4126	1.4	01.02.6001	1.6
01.01.1022	1.7	01.01.2013	1.8	01.02.10003	1.6	01.02.4127	1.4	01.02.6002	1.6
01.01.1023	1.7	01.01.2014	1.8	01.02.1205	1.3	01.02.4128	1.4	01.02.6004	1.6
01.01.1026	1.7	01.01.2016	1.8	01.02.1206	1.3	01.02.4129	1.4	01.02.6010	1.6
01.01.1027	1.7	01.01.2017	1.8	01.02.1208	1.3	01.02.4130	1.5	01.02.6011	1.6
01.01.1028	1.7	01.01.2019	1.8	01.02.1210	1.3	01.02.4131	1.5	01.02.6018	1.6
01.01.1033	1.7	01.01.2020	1.8	01.02.1211	1.3	01.02.4132	1.5	01.02.6024	1.6
01.01.1034	1.7	01.01.2022	1.8	01.02.1212	1.3	01.02.4134	1.5	01.02.6034	1.6
01.01.1037	1.7	01.01.2024	1.8	01.02.1217	1.3	01.02.4137	1.5	01.02.6035	1.6
01.01.1042	1.7	01.01.2025	1.8	01.02.1221	1.3	01.02.4138	1.5	01.02.8106	1.13
01.01.1049	1.7	01.01.2026	1.8	01.02.1222	1.3	01.02.4140	1.5	01.02.8115	1.13
01.01.1050	1.7	01.01.2028	1.8	01.02.1226	1.3	01.02.4145	1.5	01.02.9600	1.6
01.01.1066	1.7	01.01.2029	1.8	01.02.1227	1.3	01.02.4146	1.5	01.02.9603	1.6
01.01.1067	1.7	01.01.2030	1.8	01.02.1277	1.3	01.02.4147	1.5	01.02.9605	1.6
01.01.1069	1.7	01.01.2032	1.8	01.02.1700	1.3	01.02.4148	1.5	01.02.9606	1.6
01.01.1072	1.7	01.01.2037	1.8	01.02.1709	1.3	01.02.4200	1.5	01.02.9607	1.6
01.01.1074	1.7	01.01.2051	1.8	01.02.1710	1.3	01.02.4201	1.5	01.02.9608	1.6
01.01.1076	1.7	01.01.2059	1.8	01.02.1711	1.3	01.02.4202	1.5	01.02.9609	1.6
01.01.1077	1.7	01.01.2138	1.8	01.02.1734	1.3	01.02.4203	1.5	01.02.9610	1.6
01.01.1079	1.7	01.01.2904	1.8	01.02.1735	1.3	01.02.4205	1.5	01.02.9617	1.6
01.01.1080	1.7	01.01.2921	1.8	01.02.2001	1.4	01.02.4206	1.5	01.02.9635	1.6
01.01.1083	1.7	01.01.3000	1.9	01.02.2002	1.4	01.02.4208	1.5	01.02.9636	1.6
01.01.1085	1.7	01.01.3002	1.9	01.02.2003	1.4	01.02.4209	1.5	01.02.9637	1.6
01.01.1086	1.7	01.01.3008	1.9	01.02.2004	1.4	01.02.4210	1.5	01.02.9642	1.6
01.01.1087	1.7	01.01.3100	1.9	01.02.2006	1.4	01.02.4211	1.5	01.02.9643	1.6
01.01.1101	1.7	01.01.4000	1.9	01.02.2007	1.4	01.02.4212	1.5	01.02.9644	1.6
01.01.1102	1.7	01.01.4002	1.9	01.02.2008	1.4	01.02.4219	1.5	01.02.9645	1.6
01.01.1104	1.7	01.01.4003	1.9	01.02.2011	1.4	01.02.4220	1.5	01.02.9646	1.6
01.01.1110	1.7	01.01.4005	1.9	01.02.2015	1.4	01.02.4221	1.5	01.03.100	1.2
01.01.1112	1.7	01.01.4007	1.9	01.02.2016	1.4	01.02.4222	1.5	01.03.1000	1.2
01.01.1113	1.7	01.01.4008	1.9	01.02.2025	1.4	01.02.4223	1.5	01.03.1001	1.2
01.01.1114	1.7	01.01.4014	1.9	01.02.2030	1.4	01.02.4224	1.5	01.03.1002	1.2
01.01.1116	1.7	01.01.4025	1.9	01.02.2040	1.4	01.02.4225	1.5	01.03.1003	1.2
01.01.1117	1.7	01.01.4028	1.9	01.02.2041	1.4	01.02.4226	1.5	01.03.1005	1.2
01.01.1122	1.7	01.01.4032	1.9	01.02.2044	1.4	01.02.4227	1.5	01.03.1006	1.2
01.01.1123	1.7	01.01.5101	1.9	01.02.2047	1.4	01.02.4229	1.5	01.03.1008	1.2
01.01.1127	1.7	01.01.5105	1.9	01.02.2048	1.4	01.02.4231	1.5	01.03.1009	1.2
01.01.1129	1.7	01.01.6008	1.9	01.02.2050	1.4	01.02.4233	1.5	01.03.1010	1.2
01.01.1134	1.7	01.01.6010	1.9	01.02.2060	1.4	01.02.4234	1.5	01.03.1011	1.2
01.01.1144	1.7	01.01.6930	1.9	01.02.2061	1.4	01.02.4243	1.5	01.03.1012	1.2
01.01.1155	1.7	01.01.7003	1.10	01.02.2063	1.4	01.02.4256	1.5	01.03.1016	1.2
01.01.1169	1.7	01.01.7004	1.10	01.02.2064	1.4	01.02.4259	1.5	01.03.2000	1.3
01.01.1191	1.7	01.01.7014	1.10	01.02.2065	1.4	01.02.4263	1.5	01.03.2001	1.3
01.01.1192	1.7	01.01.7016	1.10	01.02.2069	1.4	01.02.4267	1.5	01.03.2002	1.3
01.01.1200	1.7	01.01.7018	1.10	01.02.2073	1.4	01.02.4270	1.5	01.03.2003	1.3
01.01.1201	1.8	01.01.7024	1.10	01.02.2074	1.4	01.02.4271	1.5	01.03.2004	1.3
01.01.1204	1.8	01.01.8050	4.4	01.02.4104	1.4	01.02.4272	1.5	01.03.2005	1.3
01.01.1250	1.8	01.01.8956	1.10	01.02.4105	1.4	01.02.4273	1.5	01.03.2006	1.3
01.01.1252	1.8	01.01.8956	4.4	01.02.4106	1.4	01.02.4280	1.5	01.03.2007	1.3
01.01.1720	1.8	01.01.9000	1.13	01.02.4107	1.4	01.02.4283	1.5	01.03.2008	1.3

EBS Reference	Page	EBS Reference	Page	EBS Reference	Page	EBS Reference	Page	EBS Reference	Page
01.03.2009	1.3	01-468	90.7	02.01.1212.118	2.8	02.01.2024.035	2.10	02.01.24.409	2.5
01.03.2010	1.3	01-549	90.6	02.01.1212.118	2.9	02.01.2024.036	2.10	02.01.24.421	2.5
01.03.3000	1.12	01-550	90.7	02.01.1212.130	2.9	02.01.2024.066	2.10	02.01.24.423	2.5
01.03.3001	1.12	01-551	90.6	02.01.1216.051	2.20	02.01.2024.102	2.11	02.01.24.430	2.5
01.03.3002	1.12	01-552	90.8	02.01.14.002	2.5	02.01.2024.103	2.10	02.01.24.450	2.5
01.03.3003	1.12	01-629	90.5	02.01.14.010	2.5	02.01.2024.107	2.11	02.01.24.527	2.4
01.03.3004	1.12	01-810	90.6	02.01.16.002	2.5	02.01.2024.143	2.10	02.01.24.556	2.4
01.03.3005	1.12	01-811	90.8	02.01.16.004	2.5	02.01.2024.144	2.10	02.01.24.900	2.4
01.03.3006	1.12	01-812	90.6	02.01.16.010	2.5	02.01.2024.160	2.11	02.01.2424.030	2.11
01.03.3007	1.12	01-813	90.8	02.01.16.093	2.5	02.01.2024.22.0	2.8	02.01.2424.031	2.11
01.03.3008	1.12	01-891	90.5	02.01.16.353	2.4	02.01.2024.424	2.9	02.01.2424.032	2.11
01.03.6001	1.13	01-892	90.5	02.01.16.606	2.5	02.01.2024.447	2.9	02.01.2424.033	2.10
01.04.1000	1.12	01-893	90.5	02.01.16.608	2.5	02.01.2024.750	2.10	02.01.2424.034	2.10
01.04.1002	1.12	01-894	90.5	02.01.16.900	2.4	02.01.2024.755	2.11	02.01.2424.037	2.10
01.04.1003	1.12	01-924	90.8	02.01.1616.801	2.9	02.01.2024.902	2.10	02.01.2424.038	2.10
01.04.1004	1.12	01-949	90.8	02.01.1616.900	2.10	02.01.2024.905	2.11	02.01.2424.063	2.10
01.04.1005	1.12	01-950	90.6	02.01.1624.029	2.9	02.01.2030.101	2.11	02.01.2424.091	2.10
01.04.1006	1.12	01-951	90.8	02.01.1624.040	2.9	02.01.2030.22.0	2.9	02.01.2424.092	2.10
01.04.1530	1.2	01-952	90.6	02.01.1624.100	2.10	02.01.2030.406	2.10	02.01.2424.094	2.10
01.04.2407	1.2	01-953	90.8	02.01.1624.105	2.11	02.01.2030.419	2.9	02.01.2424.095	2.10
01.04.2408	1.2	01-954	90.6	02.01.1624.106	2.9	02.01.2030.425	2.9	02.01.2424.098	2.10
01.05.00.24	2.16	01-955	90.8	02.01.1624.108	2.11	02.01.2030.502	2.10	02.01.2424.103	2.11
01.06.0001	1.13	01-956	90.8	02.01.1624.22.0	2.8	02.01.2030.901	2.10	02.01.2424.104	2.11
01.06.0002	1.13	01-957	90.8	02.01.1624.331	2.9	02.01.2030.906	2.11	02.01.2424.105	2.11
01.06.0005	1.13	01-958	90.7	02.01.1624.910	2.11	02.01.22.001	2.5	02.01.2424.106	2.11
01.06.0007	1.13	01-959	90.8	02.01.1624.911	2.11	02.01.2224.110	2.10	02.01.2424.107	2.11
01.06.0008	1.13	01-961	90.7	02.01.1624.920	2.11	02.01.2224.113	2.10	02.01.2424.1070	2.10
01.26.1000	7.4	01-963	90.7	02.01.1624.922	2.11	02.01.2224.114	2.10	02.01.2424.108	2.11
01.56.00.30	2.17	01-964	90.7	02.01.1624.923	2.11	02.01.2230.010	2.10	02.01.2424.110	2.11
01-007	90.6	01-965	90.8	02.01.20.004	2.5	02.01.2230.011	2.10	02.01.2424.115	2.11
01-137	90.7	01-969	90.8	02.01.20.030	2.5	02.01.24.041	2.5	02.01.2424.116	2.11
01-138	90.7	02.00.1216.216	2.9	02.01.20.031	2.5	02.01.24.046	2.5	02.01.2424.117	2.11
01-143	90.6	02.00.1624.000	2.9	02.01.20.072	2.5	02.01.24.058	2.5	02.01.2424.118	2.11
01-144	90.6	02.00.1624.103	2.9	02.01.20.080	2.5	02.01.24.081	2.5	02.01.2424.122	2.11
01-145	90.6	02.00.2024.080	2.9	02.01.20.084	2.5	02.01.24.088	2.5	02.01.2424.123	2.11
01-146	90.7	02.00.2024.701	2.9	02.01.20.089	2.5	02.01.24.095	2.5	02.01.2424.124	2.11
01-147	90.6	02.00.2024.903	2.9	02.01.20.098	2.5	02.01.24.096	2.5	02.01.2424.140	2.10
01-148	90.7	02.00.2030.400	2.9	02.01.20.101	2.7	02.01.24.098	2.5	02.01.2424.141	2.10
0116	90.12	02.00.2030.502	2.9	02.01.20.111	2.4	02.01.24.101	2.5	02.01.2424.142	2.10
01-230	90.4	02.00.2030.543	2.9	02.01.20.111	2.5	02.01.24.106	2.4	02.01.2424.143	2.10
01-233	90.4	02.00.2030.556	2.9	02.01.20.125	2.5	02.01.24.106	2.5	02.01.2424.144	2.10
01-234	90.5	02.00.2030.901	2.9	02.01.20.126	2.5	02.01.24.115	2.5	02.01.2424.1440	2.10
01-238	90.5	02.00.2224.100	2.9	02.01.20.134	2.5	02.01.24.125	2.5	02.01.2424.145	2.10
01-239	90.5	02.00.2224.102	2.9	02.01.20.199	2.5	02.01.24.144	2.5	02.01.2424.1450	2.10
01-241	90.4	02.00.2424.085	2.9	02.01.20.406	2.5	02.01.24.201	2.5	02.01.2424.146	2.10
01-245	90.5	02.00.2424.342	2.9	02.01.20.408	2.5	02.01.24.202	2.5	02.01.2424.151	2.9
01-246	90.5	02.00.2424.346	2.9	02.01.20.409	2.5	02.01.24.207	2.5	02.01.2424.160	2.9
01-247	90.5	02.00.2430.418	2.9	02.01.20.417	2.5	02.01.24.208	2.5	02.01.2424.200	2.9
01-248	90.5	02.00.2730.002	2.9	02.01.20.450	2.5	02.01.24.292	2.5	02.01.2424.201	2.9
01-249	90.5	02.00.3030.205	2.9	02.01.20.451	2.5	02.01.24.294	2.5	02.01.2424.203	2.9
01-250	90.5	02.00.3030.215	2.9	02.01.20.490	2.4	02.01.24.295	2.5	02.01.2424.22.0	2.8
01-252	90.4	02.00.3030.241	2.9	02.01.20.491	2.4	02.01.24.3589	2.4	02.01.2424.292	2.9
01-346	90.6	02.00.3030.424	2.9	02.01.20.704	2.5	02.01.24.3593	2.4	02.01.2424.524	2.9
01-347	90.7	02.01.09.015	2.5	02.01.20.900	2.4	02.01.24.402	2.5	02.01.2424.750	2.10
01-348	90.6	02.01.09.900	2.4	02.01.20.920	2.5	02.01.24.403	2.5	02.01.2424.751	2.10
01-349	90.7	02.01.12.900	2.4	02.01.2024.030	2.10	02.01.24.408	2.5	02.01.2424.752	2.10

EBS Reference	Page	EBS Reference	Page	EBS Reference	Page	EBS Reference	Page	EBS Reference	Page
02.01.2424.755	2.11	02.01.2724.121	2.10	02.01.3030.151	2.10	02.03.12.120	2.17	02.06.1016.086	2.12
02.01.2424.900	2.11	02.01.2724.170	2.10	02.01.3030.152	2.10	02.03.1216.000	2.16	02.06.1016.087	2.12
02.01.2424.901	2.11	02.01.2724.176	2.10	02.01.3030.153	2.10	02.03.1216.001	2.16	02.06.1016.088	2.12
02.01.2430.111	2.11	02.01.2724.177	2.10	02.01.3030.156	2.10	02.03.1216.110	2.16	02.06.1016.089	2.12
02.01.2430.130	2.11	02.01.2724.180	2.10	02.01.3030.157	2.10	02.03.1216.111	2.16	02.06.1016.092	2.12
02.01.2430.131	2.11	02.01.2724.181	2.10	02.01.3030.198	2.10	02.03.1216.112	2.16	02.06.1016.093	2.12
02.01.2430.132	2.11	02.01.2724.182	2.10	02.01.3030.200	2.11	02.03.1216.113	2.16	02.06.1016.22.0	2.8
02.01.2430.133	2.11	02.01.2724.184	2.10	02.01.3030.201	2.10	02.03.1424.010	2.16	02.06.1016.300	2.15
02.01.2430.134	2.11	02.01.2724.185	2.10	02.01.3030.203	2.11	02.03.1424.011	2.16	02.06.1016.301	2.15
02.01.2430.135	2.11	02.01.2724.22.0	2.8	02.01.3030.205	2.11	02.03.1424.263	2.16	02.06.1016.305	2.15
02.01.2430.143	2.11	02.01.2724.553	2.9	02.01.3030.208	2.11	02.03.1424.2903	2.16	02.06.1016.306	2.15
02.01.2430.22.0	2.8	02.01.2724.554	2.9	02.01.3030.209	2.11	02.03.1424.2904	2.16	02.06.1016.307	2.15
02.01.2430.421	2.10	02.01.2724.840	2.10	02.01.3030.213	2.11	02.03.1624.000	2.16	02.06.12.000	2.7
02.01.2430.422	2.10	02.01.2730.001	2.11	02.01.3030.22.0	2.8	02.03.1624.001	2.16	02.06.12.011	2.7
02.01.2430.423	2.10	02.01.2730.011	2.11	02.01.3030.221	2.11	02.03.1624.321	2.16	02.06.12.201	2.6
02.01.2430.424	2.9	02.01.2730.012	2.9	02.01.3030.231	2.11	02.03.17.010	2.16	02.06.12.207	2.6
02.01.2430.430	2.11	02.01.2730.0120	2.11	02.01.3030.250	2.9	02.03.1716.310	2.16	02.06.12.212	2.6
02.01.2430.433	2.11	02.01.2730.021	2.9	02.01.3030.251	2.9	02.03.1716.311	2.16	02.06.12.213	2.6
02.01.2430.434	2.9	02.01.2730.030	2.11	02.01.3030.423	2.10	02.03.1716.312	2.16	02.06.12.215	2.6
02.01.2430.440	2.11	02.01.2730.031	2.11	02.01.3030.433	2.10	02.03.1716.313	2.16	02.06.1216.100	2.14
02.01.2430.441	2.11	02.01.2730.050	2.10	02.01.3030.440	2.10	02.03.1820.338	2.16	02.06.1216.101	2.15
02.01.2430.452	2.10	02.01.2730.051	2.10	02.01.3030.481	2.10	02.03.1820.339	2.16	02.06.1216.1010	2.10
02.01.2430.453	2.10	02.01.2730.061	2.10	02.01.3030.482	2.10	02.03.24.020	2.16	02.06.1216.102	2.14
02.01.2430.470	2.10	02.01.2730.062	2.10	02.01.3030.483	2.11	02.03.2424.050	2.16	02.06.1216.104	2.15
02.01.2430.483	2.10	02.01.2730.22.0	2.8	02.01.3030.484	2.11	02.03.2424.051	2.16	02.06.1216.106	2.15
02.01.2430.490	2.10	02.01.2730.405	2.11	02.01.3030.485	2.11	02.0327.38.00	2.2	02.06.1216.107	2.15
02.01.2430.500	2.10	02.01.2730.406	2.11	02.01.3030.486	2.11	02.04.09.90YE	2.17	02.06.1216.177	2.12
02.01.2430.501	2.10	02.01.30.008	2.5	02.01.3030.487	2.11	02.04.09.90YES	2.17	02.06.1216.178	2.12
02.01.2430.515	2.10	02.01.30.019	2.5	02.01.3030.630	2.9	02.04.0909.050	2.17	02.06.1216.196	2.12
02.01.2430.529	2.9	02.01.30.098	2.5	02.01.3030.631	2.9	02.04.0909.052	2.17	02.06.1216.197	2.12
02.01.2430.540	2.10	02.01.30.406	2.5	02.01.3030.687	2.9	02.04.0912.192	2.17	02.06.1216.198	2.12
02.01.2430.550	2.10	02.01.30.407	2.5	02.01.3030.902	2.10	02.04.0916.050	2.17	02.06.1216.22.0	2.8
02.01.2430.551	2.10	02.01.30.408	2.5	02.01.3030.903	2.11	02.04.0916.136	2.17	02.06.1224.010	2.16
02.01.2430.5510	2.10	02.01.30.411	2.5	02.01.3030PB	2.21	02.04.12.050	2.17	02.06.1224.011	2.16
02.01.2430.75	2.3	02.01.30.900	2.4	02.01.36.900	2.4	02.04.12.120FY	2.17	02.06.1224.22.0	2.8
02.01.27.001	2.5	02.01.3024.000	2.11	02.01.36.917	2.5	02.04.12.120YES	2.17	02.06.14.020	2.7
02.01.27.003	2.5	02.01.3024.001	2.11	02.03.09.001	2.16	02.04.1212.064	2.17	02.06.14.250	2.6
02.01.27.004	2.5	02.01.3024.101	2.11	02.03.09.002	2.16	02.04.1216.050	2.17	02.06.14.261	2.6
02.01.27.007	2.5	02.01.3024.201	2.11	02.03.09.005	2.16	02.04.1216.PB	2.18	02.06.14.269	2.6
02.01.27.008	2.5	02.01.3024.204	2.11	02.03.0916.000	2.16	02.04.1220.054	2.17	02.06.14.273	2.6
02.01.27.010	2.5	02.01.3024.271	2.9	02.03.0916.001	2.16	02.04.1220.9205	2.17	02.06.14.281	2.6
02.01.27.013	2.5	02.01.3024.701	2.9	02.03.0916.022	2.16	02.04.1284.122	2.17	02.06.1416.040	2.16
02.01.27.020	2.5	02.01.3024.861	2.9	02.03.0916.023	2.16	02.04.1420.251	2.17	02.06.1416.060	2.16
02.01.27.022	2.5	02.01.3024.871	2.9	02.03.0916.100	2.16	02.04.1624.19.3	2.17	02.06.1416.061	2.16
02.01.27.102	2.5	02.01.3024.910	2.10	02.03.0916.101	2.16	02.04.1624.321	2.17	02.06.1416.100	2.14
02.01.27.120	2.5	02.01.3030.002	2.11	02.03.0916.102	2.16	02.04.1624.328	2.17	02.06.1416.140	2.14
02.01.27.550	2.4	02.01.3030.003	2.11	02.03.0916.103	2.16	02.04.1824.350	2.17	02.06.1416.141	2.14
02.01.27.598	2.4	02.01.3030.081	2.9	02.03.0916.104	2.16	02.04.1824.351	2.17	02.06.1416.200	2.14
02.01.27.599	2.4	02.01.3030.091	2.9	02.03.0916.105	2.16	02.04.1824.372	2.17	02.06.1416.201	2.14
02.01.27.900	2.5	02.01.3030.100	2.10	02.03.1016.010	2.16	02.04.2024.401	2.17	02.06.1416.22.0	2.8
02.01.2724.000	2.11	02.01.3030.102	2.11	02.03.1016.011	2.16	02.04.24.200	2.17	02.06.1416.250	2.14
02.01.2724.003	2.11	02.01.3030.1020	2.10	02.03.1016.012	2.16	02.06.10.152	2.6	02.06.1416.251	2.14
02.01.2724.004	2.11	02.01.3030.115	2.10	02.03.1016.013	2.16	02.06.10.155	2.6	02.06.1416.252	2.14
02.01.2724.080	2.11	02.01.3030.117	2.10	02.03.1016.153	2.16	02.06.1016.082	2.12	02.06.1416.282	2.12
02.01.2724.081	2.11	02.01.3030.118	2.10	02.03.1016.153	2.17	02.06.1016.083	2.12	02.06.1416.297	2.12
02.01.2724.110	2.11	02.01.3030.150	2.10	02.03.1016.154	2.16	02.06.1016.084	2.12	02.06.1416.411	2.15

EBS Reference	Page	EBS Reference	Page	EBS Reference	Page	EBS Reference	Page	EBS Reference	Page
02.06.1416.420	2.15	02.06.1616.395	2.13	02.06.1824.343	2.12	02.06.2024.101	2.14	02.06.2027.437	2.12
02.06.1416.421	2.15	02.06.1616.396	2.13	02.06.1824.350	2.12	02.06.2024.120	2.16	02.06.2027.800	2.13
02.06.1424.000	2.15	02.06.1616.397	2.13	02.06.1824.351	2.12	02.06.2024.121	2.14	02.06.2027.801	2.13
02.06.1424.001	2.15	02.06.1616.400	2.15	02.06.1824.392	2.12	02.06.2024.22.0	2.8	02.06.2027.970	2.13
02.06.1424.010	2.16	02.06.1616.401	2.15	02.06.1824.393	2.12	02.06.2024.22.0HF3	2.8	02.06.2027.971	2.13
02.06.1424.012	2.16	02.06.1616.450	2.14	02.06.1824.510	2.14	02.06.2024.402	2.13	02.06.2030.22.0	2.8
02.06.1424.014	2.16	02.06.1616.451	2.14	02.06.1824.511	2.14	02.06.2024.403	2.13	02.06.2030.425	2.13
02.06.1424.015	2.16	02.06.1616.452	2.14	02.06.1827.354	2.12	02.06.2024.404	2.8	02.06.2030.426	2.13
02.06.1424.020	2.16	02.06.1616.460	2.14	02.06.1827.355	2.12	02.06.2024.404	2.13	02.06.2057	2.4
02.06.1424.021	2.16	02.06.1616.461	2.14	02.06.1827.362	2.12	02.06.2024.405	2.13	02.06.2064	2.4
02.06.1424.040	2.16	02.06.1616.800	2.14	02.06.1827.363	2.12	02.06.2024.406	2.13	02.06.2075	2.4
02.06.1424.041	2.16	02.06.1616.801	2.14	02.06.1827.370	2.12	02.06.2024.409	2.13	02.06.22.010	2.7
02.06.1424.22.0	2.8	02.06.1616.830	2.14	02.06.1827.371	2.12	02.06.2024.410	2.13	02.06.22.020	2.7
02.06.1424.253	2.12	02.06.1616.831	2.14	02.06.1864	2.4	02.06.2024.411	2.13	02.06.22.021	2.7
02.06.1424.254	2.12	02.06.1624.010H3	2.16	02.06.20.001	2.7	02.06.2024.412	2.13	02.06.22.451	2.6
02.06.1424.261	2.12	02.06.1624.011H3	2.16	02.06.20.002	2.7	02.06.2024.413	2.13	02.06.22.452	2.6
02.06.1457	2.4	02.06.1624.020	2.15	02.06.20.007	2.7	02.06.2024.414	2.13	02.06.22.458	2.6
02.06.1464	2.4	02.06.1624.021	2.15	02.06.20.020	2.7	02.06.2024.415	2.13	02.06.22.467	2.6
02.06.1564	2.4	02.06.1624.022	2.15	02.06.20.2402	2.6	02.06.2024.418	2.13	02.06.22.471	2.6
02.06.16.002	2.7	02.06.1624.023	2.15	02.06.20.2403	2.6	02.06.2024.419	2.13	02.06.22.472	2.6
02.06.16.012	2.7	02.06.1624.22.0	2.8	02.06.20.2406	2.6	02.06.2024.420	2.12	02.06.22.474	2.6
02.06.16.013	2.7	02.06.1624.22.0HF3	2.8	02.06.20.2407	2.6	02.06.2024.421	2.12	02.06.22.475	2.6
02.06.16.014	2.7	02.06.1624.302	2.13	02.06.20.2408	2.6	02.06.2024.426	2.13	02.06.22.710	2.7
02.06.16.020	2.7	02.06.1624.304	2.8	02.06.20.401	2.6	02.06.2024.427	2.13	02.06.22.711	2.7
02.06.16.021	2.7	02.06.1624.304	2.12	02.06.20.402	2.6	02.06.2024.429	2.13	02.06.2214.468	2.13
02.06.16.024	2.7	02.06.1624.305	2.12	02.06.20.403	2.6	02.06.2024.430	2.12	02.06.2224.000	2.14
02.06.16.110	2.7	02.06.1624.306	2.12	02.06.20.404	2.6	02.06.2024.433	2.13	02.06.2224.001	2.15
02.06.16.130	2.7	02.06.1624.309	2.2	02.06.20.409	2.6	02.06.2024.434	2.13	02.06.2224.002	2.14
02.06.16.300	2.6	02.06.1624.311	2.12	02.06.20.410	2.6	02.06.2024.435	2.12	02.06.2224.004	2.14
02.06.16.301	2.6	02.06.1624.312	2.12	02.06.20.411	2.6	02.06.2024.438	2.13	02.06.2224.005	2.14
02.06.16.316	2.6	02.06.1624.314	2.12	02.06.20.412	2.6	02.06.2024.452	2.13	02.06.2224.010	2.15
02.06.16.317	2.6	02.06.1624.320	2.13	02.06.20.413	2.6	02.06.2024.453	2.12	02.06.2224.011	2.15
02.06.16.324	2.6	02.06.1624.321	2.13	02.06.20.414	2.6	02.06.2024.458	2.12	02.06.2224.012	2.14
02.06.16.325	2.6	02.06.1624.328	2.13	02.06.20.415	2.6	02.06.2024.459	2.12	02.06.2224.016	2.14
02.06.16.326	2.6	02.06.1624.329	2.13	02.06.20.423	2.6	02.06.2024.462	2.12	02.06.2224.020	2.14
02.06.16.332	2.6	02.06.1624.330	2.13	02.06.20.433	2.6	02.06.2024.463	2.12	02.06.2224.021	2.15
02.06.16.335	2.6	02.06.1624.331	2.13	02.06.20.434	2.6	02.06.2024.476	2.13	02.06.2224.022	2.15
02.06.16.336	2.6	02.06.1624.332	2.12	02.06.20.435	2.6	02.06.2024.480	2.13	02.06.2224.024	2.14
02.06.16.337	2.6	02.06.1624.338	2.12	02.06.20.700	2.7	02.06.2024.481	2.13	02.06.2224.451	2.13
02.06.16.700	2.7	02.06.1624.339	2.12	02.06.20.800	2.6	02.06.2024.482	2.13	02.06.2224.460	2.12
02.06.16.710	2.7	02.06.1624.500	2.14	02.06.20.801	2.6	02.06.2024.483	2.13	02.06.2224.461	2.12
02.06.16.711	2.7	02.06.1624.501	2.14	02.06.2024.004	2.16	02.06.2024.484	2.13	02.06.2224.472	2.12
02.06.16.712	2.7	02.06.1624.1W	2.8	02.06.2024.005	2.16	02.06.2024.491	2.13	02.06.2224.473	2.12
02.06.1616.040	2.14	02.06.1627.316	2.12	02.06.2024.010	2.16	02.06.2024.492	2.13	02.06.2224.506	2.13
02.06.1616.22.0	2.8	02.06.1627.317	2.12	02.06.2024.011	2.16	02.06.2024.541	2.13	02.06.2224.8450	2.12
02.06.1616.227	2.13	02.06.1627.322	2.12	02.06.2024.012	2.14	02.06.2024.549	2.13	02.06.2224.9461	2.13
02.06.1616.303	2.12	02.06.1627.323	2.12	02.06.2024.020	2.14	02.06.2024.718	2.13	02.06.2264	2.4
02.06.1616.332	2.12	02.06.1657	2.4	02.06.2024.021	2.14	02.06.2024.719	2.13	02.06.24.001	2.7
02.06.1616.333	2.12	02.06.1664	2.4	02.06.2024.027	2.14	02.06.2024.8434	2.12	02.06.24.003	2.7
02.06.1616.334	2.12	02.06.18.010	2.7	02.06.2024.032	2.14	02.06.2024.916	2.13	02.06.24.020	2.7
02.06.1616.335	2.12	02.06.18.335	2.6	02.06.2024.034	2.14	02.06.2024.917	2.13	02.06.24.021	2.7
02.06.1616.337	2.12	02.06.18.363	2.6	02.06.2024.035	2.14	02.06.2024.9506	2.13	02.06.24.024	2.7
02.06.1616.373	2.12	02.06.18.364	2.6	02.06.2024.040	2.14	02.06.2024.961	2.14	02.06.24.025	2.7
02.06.1616.374	2.12	02.06.18.368	2.6	02.06.2024.060	2.14	02.06.2024.962	2.14	02.06.24.043	2.7
02.06.1616.379	2.12	02.06.18.369	2.6	02.06.2024.061	2.14	02.06.2024.1W	2.8	02.06.24.050	2.7
02.06.1616.387	2.12	02.06.1824.342	2.12	02.06.2024.100	2.14	02.06.2027.436	2.12	02.06.24.051	2.7

EBS Reference	Page	EBS Reference	Page	EBS Reference	Page	EBS Reference	Page	EBS Reference	Page
02.06.24.052	2.7	02.06.2416.321	2.15	02.06.2424.170	2.15	02.06.2424.570	2.12	02.06.30.603	2.6
02.06.24.053	2.7	02.06.2416.350	2.14	02.06.2424.171	2.15	02.06.2424.571	2.12	02.06.30.605	2.6
02.06.24.055	2.7	02.06.2416.351	2.14	02.06.2424.172	2.16	02.06.2424.573	2.13	02.06.30.57	2.4
02.06.24.060	2.7	02.06.2424.000	2.15	02.06.2424.1720	2.14	02.06.2424.574	2.13	02.06.30.64	2.4
02.06.24.072	2.7	02.06.2424.012	2.15	02.06.2424.173	2.14	02.06.2424.586	2.12	02.10.5486	2.2
02.06.24.081	2.7	02.06.2424.013	2.15	02.06.2424.181	2.15	02.06.2424.587	2.12	02.10.5487	2.2
02.06.24.100	2.7	02.06.2424.015	2.15	02.06.2424.200	2.15	02.06.2424.8503	2.12	02.10.5763	2.2
02.06.24.101	2.7	02.06.2424.020	2.16	02.06.2424.210	2.14	02.06.2424.8520	2.13	02.10.5764	2.2
02.06.24.102	2.7	02.06.2424.021	2.14	02.06.2424.211	2.14	02.06.2424.9500	2.13	02.10.5765	2.2
02.06.24.103	2.7	02.06.2424.022	2.14	02.06.2424.22.0HF3	2.8	02.06.2424.9502	2.13	02.10.5766	2.2
02.06.24.104	2.7	02.06.2424.023	2.14	02.06.2424.23.0	2.8	02.06.2424.9508	2.13	02.10.5767	2.2
02.06.24.123	2.7	02.06.2424.025	2.14	02.06.2424.231	2.14	02.06.2424.9543	2.13	02.10.5960	2.3
02.06.24.124	2.7	02.06.2424.027	2.14	02.06.2424.241	2.14	02.06.2424.9544	2.13	02.10.5961	2.3
02.06.24.130	2.7	02.06.2424.030	2.15	02.06.2424.251	2.15	02.06.2424.1W	2.8	02.10.6800	2.2
02.06.24.143	2.7	02.06.2424.031	2.15	02.06.2424.252	2.14	02.06.2427.519	2.13	02.10.6801	2.2
02.06.24.200	2.7	02.06.2424.032	2.15	02.06.2424.253	2.15	02.06.2430.060	2.15	02.10.6802	2.2
02.06.24.2514	2.6	02.06.2424.035	2.14	02.06.2424.260	2.16	02.06.2430.070	2.15	02.10.6803	2.2
02.06.24.2515	2.6	02.06.2424.050	2.15	02.06.2424.270	2.14	02.06.2430.100	2.15	02.10.6806	2.2
02.06.24.2523	2.6	02.06.2424.051	2.15	02.06.2424.271	2.14	02.06.2430.101	2.15	02.10.6807	2.2
02.06.24.2524	2.6	02.06.2424.052	2.14	02.06.2424.293	2.14	02.06.2430.102	2.15	02.10.6810	2.2
02.06.24.3514	2.6	02.06.2424.060	2.16	02.06.2424.300	2.15	02.06.2430.103	2.15	02.10.6811	2.2
02.06.24.3515	2.6	02.06.2424.061	2.16	02.06.2424.330	2.16	02.06.2430.119	2.12	02.10.6821	2.2
02.06.24.3516	2.6	02.06.2424.062	2.16	02.06.2424.3300.	2.14	02.06.2430.120	2.15	02.10.7562	2.3
02.06.24.501	2.6	02.06.2424.080	2.15	02.06.2424.331	2.15	02.06.2430.121	2.15	02.10.7563	2.3
02.06.24.503	2.6	02.06.2424.095	2.14	02.06.2424.3310.	2.14	02.06.2430.122	2.15	02.10.7564	2.3
02.06.24.504	2.6	02.06.2424.096	2.14	02.06.2424.332	2.15	02.06.2430.123	2.15	02.10.7565	2.3
02.06.24.505	2.6	02.06.2424.101	2.14	02.06.2424.333	2.15	02.06.2430.160	2.14	02.10.7566	2.2
02.06.24.508	2.6	02.06.2424.102	2.14	02.06.2424.334	2.15	02.06.2430.22.0	2.8	02.10.7567	2.2
02.06.24.509	2.6	02.06.2424.103	2.14	02.06.2424.336	2.16	02.06.2430.312	2.15	02.10.7568	2.2
02.06.24.520	2.6	02.06.2424.1051	2.14	02.06.2424.340	2.15	02.06.2430.313	2.15	02.10.7569	2.2
02.06.24.521	2.6	02.06.2424.108	2.15	02.06.2424.360	2.15	02.06.2430.314	2.14	02.10.7570	2.2
02.06.24.522	2.6	02.06.2424.110	2.14	02.06.2424.361	2.15	02.06.2430.342	2.15	02.10.7571	2.2
02.06.24.526	2.6	02.06.2424.1100	2.15	02.06.2424.420	2.15	02.06.2430.345	2.15	02.10.7590	2.2
02.06.24.528	2.6	02.06.2424.113	2.15	02.06.2424.421	2.15	02.06.2430.346	2.15	02.10.7591	2.2
02.06.24.532	2.6	02.06.2424.114	2.14	02.06.2424.424	2.15	02.06.2430.347	2.16	02.10.7865	2.3
02.06.24.536	2.6	02.06.2424.115	2.15	02.06.2424.425	2.15	02.06.2430.469	2.14	02.10.7866	2.3
02.06.24.537	2.6	02.06.2424.116	2.15	02.06.2424.501	2.14	02.06.2430.470	2.14	02.10.9054	2.2
02.06.24.546	2.6	02.06.2424.117	2.15	02.06.2424.502	2.12	02.06.2430.471	2.14	02.10.9055	2.2
02.06.24.700	2.7	02.06.2424.120	2.14	02.06.2424.503	2.8	02.06.2430.472	2.14	02.10.9058	2.2
02.06.24.701	2.7	02.06.2424.125	2.15	02.06.2424.503	2.13	02.06.2430.480	2.14	02.10.9059	2.2
02.06.2414.507	2.13	02.06.2424.130	2.14	02.06.2424.504	2.13	02.06.2430.500	2.12	02.10.9060	2.3
02.06.2414.510	2.13	02.06.2424.131	2.14	02.06.2424.505	2.13	02.06.2430.527	2.13	02.10.9064	2.3
02.06.2414.514	2.13	02.06.2424.150	2.16	02.06.2424.506	2.13	02.06.2430.536	2.13	02.10.9065	2.3
02.06.2414.531	2.13	02.06.2424.151	2.16	02.06.2424.507	2.12	02.06.2430.551	2.12	02.10.9267	2.2
02.06.2414.560	2.12	02.06.2424.152	2.15	02.06.2424.508	2.12	02.06.2430.552	2.12	02.10.9268	2.2
02.06.2414.561	2.12	02.06.2424.153	2.15	02.06.2424.510	2.12	02.06.2430.1W	2.8	02.10.9271	2.2
02.06.2414.562	2.12	02.06.2424.154	2.15	02.06.2424.512	2.12	02.06.2457	2.4	02.10.9272	2.2
02.06.2414.563	2.12	02.06.2424.155	2.15	02.06.2424.516	2.12	02.06.2464	2.4	02.11.2480	2.21
02.06.2416.150	2.14	02.06.2424.156	2.15	02.06.2424.517	2.12	02.06.2475	2.4	02.11.3098	2.21
02.06.2416.153	2.14	02.06.2424.157	2.15	02.06.2424.518	2.12	02.06.25.010	2.7	02.12.0516	2.21
02.06.2416.191	2.14	02.06.2424.160	2.15	02.06.2424.520	2.13	02.06.25.011	2.7	02.12.1101	2.21
02.06.2416.230	2.15	02.06.2424.161	2.15	02.06.2424.533	2.12	02.06.27.020	2.7	02.12.1123	2.21
02.06.2416.231	2.15	02.06.2424.162	2.15	02.06.2424.534	2.12	02.06.2724.020	2.16	02.12.1124	2.21
02.06.2416.290	2.14	02.06.2424.163	2.15	02.06.2424.535	2.13	02.06.2730.100	2.16	02.12.1134	2.21
02.06.2416.320	2.14	02.06.2424.164	2.16	02.06.2424.544	2.13	02.06.2730.101	2.16	02.12.1135	2.21
02.06.2416.320	2.15	02.06.2424.165	2.16	02.06.2424.545	2.13	02.06.30.411	2.7	02.12.1302	2.21

EBS Reference	Page	EBS Reference	Page	EBS Reference	Page	EBS Reference	Page	EBS Reference	Page
02.13.1000	2.3	02.30.30.75	2.3	03.07.572	3.4	03.25.9617	3.3	04.02.1414	4.2
02.13.1001	2.3	02.36.09.100	2.2	03.07.573	3.4	03.25.9618	3.3	04.02.1424	4.2
02.13.1002	2.3	02.36.09.101	2.2	03.07.610	3.4	03.36.1331	3.5	04.02.1427	4.2
02.13.1003	2.3	02.36.BPW	2.2	03.07.611	3.4	03.36.1332	3.5	04.02.1505	4.2
02.13.1004	2.3	02.37.2424.01	2.22	03.07.739	3.4	03.36.1345	3.5	04.02.1506	4.2
02.14.1000	2.4	02.37.30.01	2.22	03.07.740	3.4	03.36.1346	3.5	04.02.1511	4.2
02.14.1001	2.4	02.37.3024.01	2.22	03.07.763	3.4	03.36.536	3.5	04.02.1512	4.2
02.14.1002	2.4	02.37.3024.FL	2.22	03.07.764	3.4	03.36.537	3.5	04.02.1513	4.2
02.14.1003	2.4	02.37.3024.FR	2.22	03.07.962	3.4	03.36.572	3.5	04.02.1528	4.2
02.14.1004	2.4	02.44.BPW	2.2	03.07.963	3.4	03.36.573	3.5	04.02.1534	4.2
02.14.1005	2.4	03.07.001	3.4	03.07.964	3.4	03.36.580	3.5	04.02.1535	4.2
02.14.1006	2.4	03.07.002	3.4	03.07.965	3.4	03.36.581	3.5	04.02.1544	4.2
02.14.1254	2.18	03.07.003	3.4	03.17.049	3.6	03.36.596	3.5	04.02.1564	4.2
02.14.4122	2.4	03.07.004	3.4	03.17.050	3.6	03.36.597	3.5	04.02.1578	4.2
02.14.4138	2.4	03.07.013	3.4	03.17.064	3.6	03.36.598	3.5	04.02.1579	4.2
02.14.6699	2.4	03.07.014	3.4	03.17.065	3.6	03.36.599	3.5	04.02.1580	4.2
02.14.6753	2.18	03.07.019	3.4	03.17.072	3.6	03.36.700	3.5	04.02.1583	4.2
02.14.6754	2.18	03.07.020	3.4	03.17.073	3.6	03.36.701	3.5	04.02.1586	4.2
02.14.6883	2.4	03.07.023	3.4	03.19.037	3.6	03.36.702	3.5	04.02.1587	4.2
02.14.8782	2.4	03.07.024	3.4	03.19.038	3.6	03.36.703	3.5	04.02.1592	4.2
02.14.8783	2.4	03.07.025	3.4	03.19.039	3.6	03.36.726	3.5	04.02.1593	4.2
02.14.8823	2.18	03.07.026	3.4	03.19.040	3.6	03.36.727	3.5	04.02.1596	4.2
02.14.8845	2.18	03.07.027	3.4	03.19.045	3.6	03.36.728	3.5	04.02.1597	4.2
02.14.9449	2.18	03.07.028	3.4	03.19.046	3.6	03.36.729	3.5	04.02.1600	4.2
02.14.9458	2.18	03.07.029	3.4	03.22.001	3.6	03.36.730	3.5	04.02.1601	4.2
02.14.9470	2.4	03.07.030	3.4	03.22.002	3.6	03.36.731	3.5	04.02.1602	4.2
02.1424.BPW	2.2	03.07.065	3.4	03.22.015	3.6	03.36.736	3.5	04.02.1603	4.2
02.15.2537	2.22	03.07.066	3.4	03.22.016	3.6	03.36.737	3.5	04.02.1631	4.2
02.1524.BPW	2.2	03.07.073	3.4	03.22.031	3.8	03.36.836	3.5	04.02.1633	4.2
02.16.6425	2.22	03.07.074	3.4	03.22.032	3.8	03.36.837	3.5	04.02.1636	4.2
02.16.6517	2.22	03.07.113	3.4	03.22.034	3.8	03029902	7.2	04.02.1700	4.2
02.16.6621	2.22	03.07.114	3.4	03.22.035	3.8	03040102	7.2	04.02.1701	4.2
02.1624.57	2.3	03.07.119	3.4	03.22.220	3.6	03040502	7.2	04.02.1706	4.2
02.1824.BPW	2.2	03.07.120	3.4	03.22.230	3.6	03040602	7.2	04.02.1707	4.2
02.20.12.00	2.2	03.07.123	3.4	03.22.400	3.6	03040802	7.2	04.02.1708	4.3
02.20.16124.07	2.2	03.07.124	3.4	03.22.410	3.6	03041102	7.2	04.02.1730	4.3
02.20.1616.03	2.2	03.07.161	3.4	03.25.002	3.3	03041302	7.2	04.02.1731	4.3
02.20.1616.04	2.2	03.07.162	3.4	03.25.004	3.3	03060102	7.2	04.02.1732	4.3
02.20.1624.07	2.2	03.07.173	3.4	03.25.0072	3.3	03061102	7.2	04.02.1733	4.3
02.20.1624.08	2.2	03.07.174	3.4	03.25.0073	3.3	04.01.1003	4.4	04.02.1734	4.3
02.20.2024.01	2.2	03.07.175	3.4	03.25.189	3.3	04.01.1006	4.4	04.02.1735	4.3
02.20.2024.02	2.2	03.07.176	3.4	03.25.190	3.3	04.01.1007	4.4	04.02.1736	4.3
02.2024.64	2.3	03.07.177	3.4	03.25.201	3.3	04.01.1013	4.4	04.02.1737	4.3
02.2024.BPW	2.2	03.07.178	3.4	03.25.202	3.3	04.01.1014	4.4	04.02.1738	4.3
02.2024.ROR	2.2	03.07.3797	3.4	03.25.203	3.3	04.01.1015	4.4	04.02.1739	4.3
02.2030.75	2.3	03.07.3798	3.4	03.25.204	3.3	04.01.1021	4.4	04.02.1740	4.3
02.24.7464	2.3	03.07.380	3.4	03.25.300	3.3	04.01.1035	4.4	04.02.1741	4.3
02.24.7764	2.3	03.07.381	3.4	03.25.301	3.3	04.01.1040	4.4	04.02.1742	4.3
02.24.7964	2.3	03.07.382	3.4	03.25.302	3.3	04.01.1101	4.4	04.02.1803	4.3
02.2424.64	2.3	03.07.383	3.4	03.25.303	3.3	04.01.1102	4.4	04.02.1809	4.3
02.2424.BPW	2.2	03.07.390	3.4	03.25.304	3.3	04.01.1103	4.4	05.01.10001	5.14
02.2430.64	2.3	03.07.391	3.4	03.25.305	3.3	04.01.1110	4.4	05.01.1102	5.10
02.2430.75	2.3	03.07.528	3.4	03.25.4758	3.3	04.01.2009	4.4	05.01.1107	5.10
02.2430.BPW	2.2	03.07.529	3.4	03.25.4759	3.3	04.01.2009NE	4.4	05.01.1111	5.10
02.3030.1000	2.3	03.07.570	3.4	03.25.8189	3.3	04.02.1400	4.2	05.01.1114	5.10
02.3030.64	2.3	03.07.571	3.4	03.25.8190	3.3	04.02.1402	4.2	05.01.1124	5.10

EBS Reference	Page	EBS Reference	Page	EBS Reference	Page	EBS Reference	Page	EBS Reference	Page
05.01.1126	5.10	05.01.1438	5.13	05.05.1007	5.4	05.62.6162	5.6	06.01.1000	6.48
05.01.1127	5.10	05.01.1439	5.13	05.05.1008	5.7	05.62.6261	5.16	06.01.10000	6.49
05.01.1128	5.10	05.01.1441	5.13	05.05.1009	5.8	05.62.6321	5.16	06.01.10001	6.49
05.01.1129	5.10	05.01.1443	5.11	05.05.1010	5.6	05.62.6392	5.9	06.01.1002	6.48
05.01.1131	5.10	05.01.1451	5.13	05.05.1011	5.9	05.62.6392	5.12	06.01.1004	6.48
05.01.1132	5.10	05.01.1454	5.13	05.05.1012	5.9	05.62.6397	5.5	06.01.1009	6.48
05.01.1135	5.10	05.01.1465	5.13	05.05.1013	5.4	05.62.6397	5.6	06.01.1501	6.48
05.01.1136	5.10	05.01.1466	5.13	05.05.1014	5.4	05.62.6448	5.18	06.01.1805	6.48
05.01.1137	5.10	05.01.1601	5.13	05.05.1015	5.4	05.62.6597	5.17	06.01.2003	6.48
05.01.1150	5.10	05.01.2028	5.13	05.05.5000	5.19	05.62.6639	5.9	06.01.2008	6.48
05.01.1151	5.10	05.01.2034	5.13	05.05.5001	5.19	05.62.6639	5.11	06.01.2018	6.48
05.01.1152	5.11	05.01.3114	5.10	05.05.5002	5.19	05.62.6661	5.16	06.01.2019	6.48
05.01.1154	5.11	05.01.4001	5.13	05.05.5003	5.19	05.62.6662	5.16	06.01.2025	6.48
05.01.1157	5.11	05.01.5001	5.14	05.05.5004	5.19	05.62.6664	5.17	06.01.2027	6.48
05.01.1158	5.11	05.02.1156	5.2	05.05.5005	5.19	05.62.6693	5.5	06.01.2030	6.48
05.01.1159	5.11	05.02.1200	5.2	05.05.5006	5.19	05.62.7494	5.17	06.01.3052	6.48
05.01.1163	5.11	05.02.1204	5.2	05.05.5007	5.19	05.62.7496	5.16	06.01.3060	6.48
05.01.1164	5.11	05.02.1208	5.2	05.05.5008	5.19	05.62.7497	5.6	06.01.3104	6.48
05.01.1168	5.11	05.02.1213	5.2	05.05.5009	5.19	05.62.7498	5.6	06.01.3150	6.48
05.01.1169	5.11	05.02.1215	5.2	05.05.5010	5.19	05.62.7612	5.7	06.01.3506	6.48
05.01.1171	5.11	05.02.1218	5.2	05.05.5011	5.19	05.62.7946A	5.8	06.01.4000	6.48
05.01.1174	5.11	05.02.1224	5.2	05.05.5012	5.19	05.62.8036	5.3	06.01.4001	6.49
05.01.1176	5.11	05.02.1227	5.2	05.05.5013	5.19	05.62.8258	5.4	06.01.4002	6.49
05.01.1179	5.11	05.02.1228	5.2	05.05.5014	5.19	05.62.8260	5.4	06.01.4004	6.49
05.01.1181	5.11	05.02.1229	5.2	05.05.5015	5.19	05.62.8277	5.4	06.01.4006	6.49
05.01.1182	5.11	05.02.1234	5.2	05.06.1000	5.14	05.62.8277	5.7	06.01.4012	6.49
05.01.1183	5.11	05.02.1261	5.2	05.06.1001	5.14	05.62.8448	5.5	06.01.4029	6.49
05.01.1190	5.11	05.02.1262	5.2	05.06.1002	5.14	05.62.8449	5.5	06.01.4104	6.49
05.01.1191	5.11	05.02.1267	5.2	05.09.1605	5.14	05.62.8450	5.5	06.02.10000	6.46
05.01.1204	5.12	05.02.1268	5.2	05.09.1608	5.14	05.62.8494	5.9	06.02.10001	6.46
05.01.1205	5.12	05.02.1276	5.2	05.09.1610	5.14	05.62.8554	5.8	06.02.1314	6.43
05.01.1209	5.12	05.02.1284	5.2	05.09.1611	5.14	05.62.9134	5.5	06.02.1506	6.43
05.01.1217	5.12	05.02.1286	5.2	05.09.1613	5.14	05.62.9135	5.5	06.02.1527	6.43
05.01.1218	5.12	05.02.1288	5.3	05.09.1617	5.14	05.62.9137	5.18	06.02.1802	6.43
05.01.1220	5.12	05.02.1289	5.3	05.09.1632	5.14	05.62.9184	5.7	06.02.1813	6.43
05.01.1224	5.12	05.02.1304	5.3	05.09.1633	5.14	05.62.9218	5.17	06.02.1841	6.43
05.01.1307	5.12	05.02.1361	5.3	05.11.1001	5.15	05.62.9218	5.18	06.02.1859	6.43
05.01.1402	5.12	05.02.1874	5.3	05.11.1010	5.15	05.62.9219	5.18	06.02.1875	6.43
05.01.1405	5.12	05.02.2028	5.3	05.11.1020	5.15	05.62.9276	5.9	06.02.1901	6.43
05.01.1406	5.12	05.02.2727	5.16	05.11.1032	5.15	05.62.9277	5.9	06.02.1920	6.43
05.01.1407	5.12	05.02.2858	5.16	05.11.1040	5.15	05.62.9300	5.7	06.02.1927	6.44
05.01.1412	5.12	05.02.2875	5.16	05.41.1000	5.18	05.62.9303	5.18	06.02.1937	6.44
05.01.1413	5.12	05.02.4873	5.3	05.41.1001	5.18	05.62.9479	5.5	06.02.1939	6.44
05.01.1414	5.12	05.02.4874	5.3	05.62.2109	5.8	05.62.9582	5.16	06.02.1941	6.44
05.01.1415	5.12	05.02.9547	5.3	05.62.2109	5.12	05.62.9614	5.18	06.02.1947	6.44
05.01.1419	5.12	05.03.1000	5.15	05.62.2190	5.8	05.62.9683	5.8	06.02.1951	6.44
05.01.1422	5.12	05.03.1001	5.15	05.62.2199	5.8	05.62.9862	5.16	06.02.1960	6.44
05.01.1423	5.13	05.03.1003	5.15	05.62.4199	5.8	05.62.9920	5.18	06.02.1966	6.43
05.01.1424	5.13	05.03.1005	5.15	05.62.5375	5.7	05.63.0361	5.6	06.02.1970	6.44
05.01.1429	5.13	05.05.1000	5.9	05.62.5436	5.6	05.63.0388	5.16	06.02.1973	6.43
05.01.1430	5.13	05.05.1001	5.9	05.62.5559	5.6	05.63.0424	5.7	06.02.1980	6.44
05.01.1431	5.13	05.05.1002	5.6	05.62.5586	5.6	05.63.0889	5.9	06.02.2812	6.44
05.01.1432	5.13	05.05.1003	5.4	05.62.5671	5.5	05.63.1355	5.18	06.02.2813	6.44
05.01.1435	5.13	05.05.1004	5.4	05.62.5942	5.18	0501.211.290	5.18	06.02.2814	6.44
05.01.1436	5.13	05.05.1005	5.7	05.62.5944	5.18	0501.215.299	5.18	06.02.2815	6.44
05.01.1437	5.13	05.05.1006	5.7	05.62.6156	5.18	054997	7.2	06.02.2823	6.44

EBS Reference	Page	EBS Reference	Page	EBS Reference	Page	EBS Reference	Page	EBS Reference	Page
06.02.2825	6.44	07.01.6026	7.5	08.01.T070	8.7	09.01.1479	9.12	09.01.6512	9.17
06.02.2828	6.44	07.01.6031	7.5	08.01.V022	8.9	09.01.2004	9.12	09.01.7000	9.15
06.02.2844	6.44	07.01.6032	7.5	08.01.W628	8.5	09.01.2008	9.12	09.01.8001	9.18
06.02.2845	6.45	07.02.1000	7.3	08.01.W639	8.5	09.01.2012	9.12	09.01.8002	9.18
06.02.2850	6.45	07.02.1001	7.3	08.01.X628	8.5	09.01.2017	9.12	09.01.8005	9.18
06.02.2851	6.45	07.02.1002	7.3	08.01.X639	8.5	09.01.2018	9.12	09.01.9000	9.17
06.02.2855	6.45	07.04.1000	7.2	08.01.Y426	8.7	09.01.2019	9.12	09.01.A010	9.6
06.02.2857	6.45	07.06.3000	7.2	08.04.1000	8.3	09.01.2022	9.12	09.01.A010	9.15
06.02.2865	6.45	07.27.1000	7.4	08.04.1001	8.3	09.01.2023	9.12	09.01.A010	9.18
06.02.2871	6.45	07.28.1000	7.4	08.04.1002	8.3	09.01.2026	9.13	09.01.A011	9.6
06.02.2927	6.45	07.29.2000	7.4	08.10.1000	8.2	09.01.2030	9.13	09.01.A011	9.15
06.02.2934	6.45	07.29.2001	7.4	08.10.1001	8.2	09.01.2036	9.13	09.01.A011	9.18
06.02.2940	6.45	07.31.1000	7.2	08.10.1002	8.2	09.01.2042	9.13	09.01.A500	9.18
06.02.2955	6.45	07.32.1000	7.2	08.10.1003	8.2	09.01.2043	9.13	09.01.C000	9.18
06.02.2957	6.45	07.33.1000	7.4	08.21.1000	8.3	09.01.2047	9.13	09.01.C004	9.18
06.02.2960	6.45	07.42.1000	7.5	08.21.1001	8.3	09.01.2061	9.13	09.01.C039	9.18
06.02.2961	6.45	08.01.B480	8.5	08.21.1002	8.8	09.01.2070	9.13	09.02.0158	9.7
06.02.2964	6.45	08.01.C108	8.5	08.21.1003	8.3	09.01.2077	9.13	09.02.0159	9.7
06.02.2967	6.45	08.01.H140	8.5	08.21.1004	8.3	09.01.2082	9.13	09.02.4419	9.7
06.02.2974	6.46	08.01.J001	8.5	08.26.1000	8.9	09.01.2086	9.13	09.02.4434	9.7
06.02.2983	6.46	08.01.J600	8.5	08.26.1001	8.3	09.01.2150	9.13	09.02.4469	9.7
06.02.2985	6.46	08.01.J604	8.5	08.26.1002	8.3	09.01.2154	9.13	09.02.4613	9.7
06.02.2992	6.46	08.01.J606	8.5	08.27.1000	8.8	09.01.2180	9.13	09.02.4629	9.8
06.02.2997	6.46	08.01.J636	8.5	08.27.1001	8.8	09.01.2245	9.14	09.02.4630	9.8
06.02.3813	6.46	08.01.K000	8.5	08.27.1002	8.8	09.01.2247	9.14	09.02.4636	9.8
06.02.3907	6.46	08.01.K336	8.6	08.28.1000	8.4	09.01.2248	9.14	09.02.4653	9.8
06.06.1000	6.46	08.01.K700	8.6	08.28.1001	8.4	09.01.2250	9.14	09.02.4694	9.9
06.06.1001	6.46	08.01.K704	8.6	08.28.1002	8.4	09.01.2258	9.14	09.02.4696	9.7
06.06.1002	6.46	08.01.K706	8.6	08.29.1000	8.3	09.01.2261	9.14	09.02.4815	9.7
06.06.1003	6.46	08.01.K726	8.6	08.29.1001	8.2	09.01.2263	9.14	09.02.4815	9.9
06.06.1004	6.46	08.01.K908	8.5	08.29.1003	8.2	09.01.2264	9.14	09.02.4820	9.9
06.06.1014	6.47	08.01.L001	8.6	08.29.1004	8.2	09.01.2475	9.14	09.02.4821	9.9
06.07.1000	6.47	08.01.L600	8.6	08.29.1005	8.2	09.01.2479	9.14	09.02.4825	9.7
06.07.1001	6.47	08.01.L604	8.6	08.29.1006	8.3	09.01.2482	9.14	09.02.4825	9.9
06.07.1002	6.47	08.01.L606	8.6	08.29.1007	8.8	09.01.2490	9.14	09.02.4837	9.7
06.26.1001	6.47	08.01.L620	8.6	08.29.1008	8.8	09.01.2491	9.14	09.02.4837	9.9
06.26.1002	6.47	08.01.L626	8.6	08.29.1009	8.8	09.01.2495	9.15	09.02.4849	9.9
06.26.1003	6.47	08.01.L686	8.6	08.30.1000	8.8	09.01.2497	9.15	09.02.4928	9.7
06.26.1004	6.47	08.01.L726	8.6	08.30.10001	8.4	09.01.3008	9.15	09.02.9530	9.7
06.26.1005	6.47	08.01.L786	8.6	08.30.10002	8.4	09.01.3018	9.15	09.02.9544	9.7
06.26.1006	6.47	08.01.L901	8.6	08.30.1001	8.2	09.01.3032	9.15	09.02.9569	9.8
06.26.1007	6.47	08.01.M000EX	8.7	08.30.1002	8.2	09.01.3250	9.15	09.02.9571	9.8
06.44.7710	6.47	08.01.M003	8.7	08.30.1003	8.2	09.01.3260	9.15	09.04.1000	9.4
07.01.1000	7.4	08.01.N152	8.5	08.30.1004	8.2	09.01.3270	9.16	09.04.1001	9.3
07.01.1001	7.4	08.01.N202	8.5	08.30.1005	8.8	09.01.3271	9.16	09.04.1002	9.4
07.01.1005	7.4	08.01.P005	8.7	08.30.1006	8.8	09.01.3272	9.16	09.04.1003	9.4
07.01.1016	7.4	08.01.P006	8.7	08.30.1007	8.8	09.01.3273	9.16	09.04.1004	9.4
07.01.1024	7.5	08.01.P011	8.7	08.30.1008	8.8	09.01.3274	9.16	09.04.1005	9.5
07.01.2001	7.5	08.01.R206	8.6	08.30.1009	8.8	09.01.4520	9.16	09.04.1006	9.4
07.01.2004	7.5	08.01.R226	8.6	08.30.1010	8.9	09.01.5102	9.16	09.04.2000	9.5
07.01.2006	7.5	08.01.R428	8.6	08.30.1011	8.8	09.01.6500	9.17	09.04.2001	9.5
07.01.3000	7.5	08.01.R700	8.6	08.30.2001	8.4	09.01.6501	9.17	09.04.2002	9.5
07.01.4002	7.5	08.01.R701	8.7	08.32.1000	8.9	09.01.6502	9.17	09.06.1000	9.3
07.01.4104	7.5	08.01.R704	8.7	09.01.1419	9.12	09.01.6509	9.17	09.06.1001	9.3
07.01.4920	7.5	08.01.S316	8.7	09.01.1439	9.12	09.01.6510	9.17	09.06.1002	9.3
07.01.5000	7.5	08.01.S916	8.7	09.01.1475	9.12	09.01.6511	9.17	09.06.1003	9.2

EBS Reference	Page	EBS Reference	Page	EBS Reference	Page	EBS Reference	Page	EBS Reference	Page
09.06.1004	9.2	10.03.097	10.7	10.30.1014	10.5	11.06.1003	11.2	12.01.6003	12.8
09.06.1005	9.2	10.03.098	10.7	10.30.913	10.9	11.06.1004	11.2	12.01.6004	12.8
09.06.1006	9.2	10.04.052	10.7	10.30.920	10.9	11.06.1005	11.2	12.01.6005	12.8
09.06.1007	9.2	10.04.058	10.7	10.30.926	10.9	11.06.1006	11.2	12.01.6007	12.8
09.06.1008	9.2	10.04.063	10.7	10.42.1001	10.5	11.06.1007	11.2	12.01.6008	12.8
09.06.1009	9.19	10.04.065	10.7	1025285/F	7.4	11.06.1008	11.2	12.01.6010	12.8
09.07.1000	9.10	10.04.066	10.8	11.01.1256	11.4	11.06.1009	11.2	12.01.6011	12.8
09.07.1001	9.10	10.04.853	10.8	11.01.2110	11.4	11.06.1010	11.2	12.01.6015	12.8
09.07.1002	9.11	10.04.854	10.8	11.01.3000	11.4	11.06.1011	11.2	12.01.6016	12.8
09.07.1003	9.11	10.04.855	10.8	11.01.3040	11.4	11.06.1012	11.2	12.01.6017	12.8
09.07.1004	9.11	10.04.856	10.8	11.01.3060	11.4	11.07.1000	11.4	12.01.6019	12.8
09.07.1005	9.11	10.06.009	10.6	11.01.3061	11.4	12.01.10001	12.9	12.01.6021	12.9
09.07.1006	9.11	10.06.010	10.6	11.01.3072	11.4	12.01.1100	12.5	12.01.6022	12.9
09.07.1007	9.11	10.06.011	10.6	11.01.3081	11.4	12.01.1105	12.5	12.01.6023	12.9
09.07.1008	9.10	10.06.013	10.7	11.01.3082	11.4	12.01.2001	12.5	12.01.6025	12.9
09.07.1010	9.11	10.06.043	10.6	11.01.3083	11.4	12.01.2004	12.5	12.01.6026	12.9
09.07.1011	9.11	10.06.044	10.6	11.01.3086	11.4	12.01.2008	12.5	12.01.6027	12.9
09.07.1015	9.11	10.06.045	10.6	11.01.3091	11.4	12.01.3001	12.5	12.01.6028	12.9
09.07.1016	9.11	10.06.055	10.6	11.01.3120	11.4	12.01.4000	12.5	12.01.6031	12.9
09.08.1000	9.6	10.06.091	10.6	11.01.3121	11.4	12.01.4004	12.5	12.01.6039	12.9
09.09.1000	9.6	10.06.095	10.6	11.01.3141	11.4	12.01.4010	12.5	12.01.6040	12.9
09.09.1001	9.6	10.10.1000	10.3	11.01.3220	11.4	12.01.4011	12.5	12.01.6041	12.9
09.09.1002	9.6	10.21.1000	10.3	11.01.3441	11.4	12.01.4017	12.5	12.01.6100	12.9
09.09.1003	9.6	10.21.1001	10.3	11.01.3442	11.4	12.01.4020	12.5	12.01.6102	12.9
09.09.1004	9.6	10.21.1002	10.3	11.01.3446	11.4	12.01.4033	12.5	12.01.6104	12.9
09.10.1000	9.19	10.21.1003	10.3	11.01.3447	11.4	12.01.4040	12.5	12.01.6107	12.9
09.10.1001	9.19	10.26.1000	10.3	11.01.3464	11.4	12.01.4044	12.6	12.01.6108	12.9
09.37.1000	9.6	10.27.1000	10.3	11.01.3465	11.4	12.01.4054	12.6	12.01.6109	12.9
09.37.1001	9.6	10.27.1001	10.3	11.01.3469	11.4	12.01.5150	12.6	12.01.6110	12.10
10.01.10000	10.5	10.27.1002	10.4	11.01.3472	11.4	12.01.5151	12.6	12.01.6111	12.10
10.01.1112	10.2	10.27.1003	10.4	11.01.3473	11.4	12.01.5156	12.6	12.01.6112	12.10
10.01.1114	10.2	10.27.1004	10.4	11.01.3474	11.4	12.01.5160	12.6	12.01.6115	12.10
10.01.1116	10.2	10.27.1005	10.4	11.01.3479	11.4	12.01.5170	12.6	12.01.6116	12.10
10.01.1122	10.2	10.27.109	10.8	11.01.3480	11.4	12.01.5172	12.6	12.01.6118	12.10
10.01.1126	10.2	10.27.2001	10.4	11.01.3490	11.4	12.01.5212	12.6	12.01.6122	12.10
10.01.1130	10.2	10.27.209	10.8	11.01.3491	11.4	12.01.5232	12.6	12.01.6123	12.10
10.01.1200	10.2	10.27.298	10.8	11.01.3503	11.4	12.01.5250	12.6	12.01.6125	12.10
10.01.1210	10.2	10.27.309	10.9	11.01.3504	11.4	12.01.5251	12.6	12.01.6127	12.10
10.01.3082	10.5	10.27.398	10.9	11.01.3541	11.4	12.01.5252	12.6	12.01.6134	12.10
10.01.6111	10.2	10.27.509	10.9	11.01.3580	11.4	12.01.5253	12.7	12.01.6139	12.10
10.01.8004	10.2	10.29.1000	10.5	11.01.3661	11.4	12.01.5258	12.7	12.01.6140	12.10
10.01.9002	10.2	10.30.048	10.9	11.02.1000	11.4	12.01.5260	12.7	12.01.6200	12.10
10.02.058	10.6	10.30.1000	10.4	11.02.1001	11.4	12.01.5262	12.7	12.01.6201	12.10
10.02.059	10.6	10.30.1001	10.4	11.02.1002	11.4	12.01.5264	12.7	12.01.6203	12.10
10.02.060	10.6	10.30.1002	10.4	11.04.1000	11.3	12.01.5265	12.7	12.01.6208	12.11
10.02.3302	10.3	10.30.1003	10.4	11.04.1001	11.3	12.01.5266	12.7	12.01.6212	12.11
10.02.3336	10.3	10.30.1004	10.10	11.04.1002	11.3	12.01.5269	12.7	12.01.6213	12.11
10.02.3360	10.3	10.30.1005	10.4	11.04.1003	11.3	12.01.5275	12.7	12.01.6215	12.11
10.02.3367	10.3	10.30.1006	10.4	11.04.1004	11.3	12.01.5284	12.7	12.01.6217	12.11
10.02.3368	10.3	10.30.1007	10.4	11.04.1005	11.3	12.01.5302	12.7	12.01.6403	12.11
10.02.3371	10.3	10.30.1008	10.5	11.04.1006	11.3	12.01.5305	12.7	12.01.6418	12.11
10.03.055	10.7	10.30.1009	10.5	11.04.1007	11.3	12.01.5306	12.7	12.01.6420	12.11
10.03.056	10.7	10.30.1010	10.5	11.04.1008	11.3	12.01.5314	12.8	12.01.6421	12.11
10.03.070	10.7	10.30.1011	10.5	11.06.1000	11.2	12.01.5324	12.8	12.01.7208	12.12
10.03.077	10.7	10.30.1012	10.5	11.06.1001	11.2	12.01.5325	12.8	12.01.7209	12.12
10.03.096	10.7	10.30.1013	10.5	11.06.1002	11.2	12.01.6001	12.8	12.01.7224	12.12

EBS Reference	Page	EBS Reference	Page	EBS Reference	Page	EBS Reference	Page	EBS Reference	Page
12.01.7225	12.12	13.01.1054	13.4	14.01.10000	14.4	14.02.1000	14.14	14.03.1007	14.6
12.02.1143	12.3	13.01.1055	13.4	14.01.1310	14.13	14.02.1001	14.14	14.03.1008	14.6
12.02.1147	12.3	13.01.1056	13.5	14.01.1312	14.13	14.02.1260	14.8	14.03.1009	14.16
12.02.1176	12.3	13.01.1057	13.5	14.01.1330	14.13	14.02.1280	14.8	14.03.1009	15.11
12.02.1241	12.3	13.01.1058	13.5	14.01.1332	14.13	14.02.1281	14.8	14.03.1010	14.16
12.02.1350	12.3	13.01.1059	13.5	14.01.1360	14.8	14.02.1287	14.5	14.03.1010	15.11
12.04.1000	12.2	13.01.1060	13.5	14.01.1360	14.13	14.02.1287	14.8	14.04.1000	14.4
12.06.1000	12.3	13.01.1061	13.5	14.01.1530	14.13	14.02.1288	14.8	14.04.1001	14.4
12.06.1001	12.3	13.01.1062	13.5	14.01.1532	14.13	14.02.1294	14.8	14.04.1003	14.4
12.06.1002	12.3	13.01.1063	13.5	14.01.2000	14.13	14.02.1295	14.9	14.04.1004	14.4
12.07.1000	12.4	13.01.1064	13.5	14.01.3000	14.13	14.02.1303	14.9	14.04.1005	14.5
12.07.10001	12.4	13.01.1065	13.5	14.01.3002	14.13	14.02.1304	14.9	14.04.1006	14.5
12.07.1001	12.4	13.01.1067	13.5	14.01.3012	14.13	14.02.1307	14.9	14.04.1007	14.4
12.07.1002	12.4	13.01.1073	13.5	14.01.3100	14.13	14.02.1310	14.9	14.04.1008	14.4
12.07.1003	12.4	13.01.1074	13.5	14.01.4001	14.3	14.02.1318	14.9	14.04.1009	14.4
12.07.1004	12.4	13.01.1101	13.5	14.01.4002	14.3	14.02.1323	14.9	14.04.1010	14.4
12.07.1005	12.4	13.01.1102	13.5	14.01.4003	14.3	14.02.1325	14.9	14.04.1011	14.5
12.07.1006	12.4	13.01.1110	13.6	14.01.4004	14.3	14.02.1328	14.9	14.04.1012	14.5
12.07.1007	12.4	13.01.1112	13.6	14.01.4006	14.3	14.02.1329	14.9	14.04.1013	14.8
12.07.1007	12.9	13.01.1113	13.6	14.01.4007	14.3	14.02.1343	14.10	14.04.1014	14.8
12.07.1008	12.4	13.01.1114	13.6	14.01.4008	14.3	14.02.1344	14.10	14.04.1015	14.8
12.07.1009	12.4	13.01.2107	13.6	14.01.4009	14.3	14.02.1345	14.10	14.04.1016	14.8
12.07.1010	12.4	13.01.2111	13.6	14.01.4010	14.3	14.02.1350	14.10	14.04.1017	14.8
12.07.1011	12.4	13.01.2114	13.6	14.01.4011	14.3	14.02.1351	14.10	14.06.1037	14.16
12.07.1012	12.4	13.01.2116	13.6	14.01.4013	14.3	14.02.1361	14.10	14.06.1037	15.11
12.07.1013	12.4	13.01.2118	13.6	14.01.4014	14.3	14.02.1362	14.10	14.06.3027	14.16
12.07.1014	12.4	13.01.3000	13.3	14.01.4015	14.3	14.02.1370	14.10	14.06.3027	15.11
12.07.1015	12.4	13.01.3001	13.3	14.01.4016	14.3	14.02.1371	14.10	14.08.1000	14.5
12.07.1016	12.4	13.01.3004	13.3	14.01.4017	14.3	14.02.1376	14.10	14.13.1000	14.7
12.07.1017	12.4	13.01.3020	13.3	14.01.4018	14.3	14.02.1380	14.9	14.30.1000	14.2
12.07.1018	12.4	13.01.3021	13.3	14.01.4019	14.4	14.02.1380	14.10	14.30.1001	14.2
12.07.1019	12.4	13.01.3024	13.3	14.01.4020	14.4	14.02.1395	14.11	14.30.1014	14.2
12.07.1020	12.4	13.01.3030	13.3	14.01.4021	14.4	14.02.1399	14.11	15.01.0001	15.10
12.07.1021	12.4	13.01.3032	13.3	14.01.4022	14.4	14.02.1410	14.11	15.01.0002	15.10
12.07.1022	12.4	13.01.3050	13.3	14.01.4023	14.4	14.02.1411	14.11	15.01.0003	15.10
12.07.1023	12.4	13.01.3061	13.3	14.01.4025	14.4	14.02.1412	14.11	15.01.0004	15.10
12.07.1024	12.4	13.01.3064	13.3	14.01.6006	14.14	14.02.1425	14.11	15.01.0005	15.10
12.07.1025	12.4	13.01.3065	13.3	14.01.6007	14.14	14.02.1425	14.11	15.01.0006	15.10
12.07.1027	12.4	13.01.3100	13.3	14.01.6008	14.14	14.02.1426	14.11	15.01.0007	15.10
12.07.1028	12.4	13.01.3103	13.3	14.01.6010	14.14	14.02.1426	14.11	15.01.0009	15.10
12.07.1030	12.4	13.01.3104	13.3	14.01.6011	14.15	14.02.1440	14.11	15.01.1120	15.5
12.08.1000	12.3	13.01.4003	13.4	14.01.6012	14.15	14.02.1447	14.12	15.01.1122	15.5
12.09.1000	12.3	13.01.4022	13.3	14.01.6013	14.15	14.02.1465	14.12	15.01.1126	15.5
13.01.1001	13.4	13.01.6117	13.8	14.01.6100	14.15	14.02.1466	14.12	15.01.1220	15.5
13.01.1002	13.4	13.02.1000	13.2	14.01.6101	14.15	14.02.1490	14.12	15.01.1401	15.5
13.01.1009	13.4	13.02.1001	13.2	14.01.6120	14.15	14.02.1496	14.2	15.01.1402	15.5
13.01.1012	13.4	13.02.1002	13.2	14.01.6121	14.15	14.03.1000	14.16	15.01.1403	15.5
13.01.1013	13.4	13.03.1000	13.7	14.01.6122	14.15	14.03.1000	15.11	15.01.1404	15.5
13.01.1014	13.4	13.04.1000	13.2	14.01.6123	14.15	14.03.10001	14.7	15.01.2001	15.5
13.01.1021	13.4	13.04.1001	13.2	14.01.6202	14.15	14.03.1001	14.6	15.01.2020	15.5
13.01.1022	13.4	13.04.1002	13.2	14.01.6203	14.15	14.03.1002	14.6	15.01.3000	15.6
13.01.1032	13.4	13.04.1003	13.2	14.01.7002	14.16	14.03.1003	14.6	15.01.3002	15.6
13.01.1033	13.4	13.04.1005	13.2	14.01.7002	15.11	14.03.1003	14.7	15.01.3003	15.6
13.01.1050	13.4	13.04.1006	13.2	14.01.7025	14.16	14.03.1004	14.2	15.01.3006	15.6
13.01.1052	13.4	13.04.1007	13.2	14.01.9730	14.16	14.03.1005	14.7	15.01.3007	15.4
13.01.1053	13.4	13.04.1008	13.2	14.01.9730	15.11	14.03.1006	14.7	15.01.3007	15.6

EBS Reference	Page	EBS Reference	Page	EBS Reference	Page	EBS Reference	Page	EBS Reference	Page
15.01.3008	15.6	15.01.4017	15.7	15.01.4118	15.8	15.03.1000	15.3	16.35.1036	16.2
15.01.3009	15.6	15.01.4020	15.7	15.01.4119	15.8	15.06.1000	15.2	16.35.1037	16.4
15.01.3011	15.6	15.01.4021	15.7	15.01.4120	15.8	15.06.1001	15.2	16.35.1038	16.5
15.01.3012	15.4	15.01.4022	15.7	15.01.4121	15.8	15.06.1002	15.2	16.35.1039	16.5
15.01.3012	15.6	15.01.4023	15.7	15.01.4122	15.8	15.06.1003	15.2	16.35.1040	16.5
15.01.3013	15.6	15.01.4024	15.7	15.01.4125	15.8	15.06.1004	15.2	16.35.1041	16.4
15.01.3014	15.6	15.01.4025	15.7	15.01.4126	15.8	15.06.1005	15.2	16.35.1042	16.5
15.01.3016	15.4	15.01.4026	15.7	15.01.4127	15.8	15.06.1006	15.2	16.35.1043	16.3
15.01.3016	15.6	15.01.4027	15.7	15.01.4128	15.8	15.06.1007	15.2	16.62.3104	16.6
15.01.3020	15.6	15.01.4028	15.7	15.01.4129	15.8	15.06.1008	15.2	16.62.3105	16.6
15.01.3021	15.6	15.01.4029	15.7	15.01.4131	15.8	15.06.1009	15.2	16.62.3106	16.6
15.01.3022	15.6	15.01.4030	15.7	15.01.4134	15.8	16.01.1520	16.7	16.62.3109	16.6
15.01.3024	15.4	15.01.4031	15.7	15.01.4136	15.8	16.01.2006WR	16.7	16.62.3160	16.6
15.01.3024	15.6	15.01.4032	15.4	15.01.4137	15.8	16.01.3902	16.7	16.62.4248	16.6
15.01.3025	15.4	15.01.4032	15.7	15.01.4138	15.8	16.01.4008	16.7	16.62.4502	16.6
15.01.3025	15.6	15.01.4033	15.7	15.01.4142	15.8	16.02.2011	16.5	16.62.4503	16.6
15.01.3028	15.6	15.01.4034	15.7	15.01.4143	15.8	16.02.2123	16.5	16.62.5536	16.6
15.01.3029	15.6	15.01.4036	15.7	15.01.4145	15.8	16.02.3984	16.5	16.62.5826	16.6
15.01.3031	15.6	15.01.4037	15.7	15.01.4146	15.8	16.35.1000	16.2	16.62.6159	16.6
15.01.3032	15.6	15.01.4038	15.7	15.01.4148	15.8	16.35.10000	16.5	16.62.6159COM	16.7
15.01.3033	15.6	15.01.4039	15.7	15.01.4149	15.8	16.35.1001	16.3	16.62.6564	16.6
15.01.3035	15.6	15.01.4040	15.7	15.01.4150	15.8	16.35.1002	16.4	16.62.6760	16.6
15.01.3036	15.6	15.01.4041	15.7	15.01.4154	15.8	16.35.1003	16.2	16.62.6761	16.6
15.01.3039	15.6	15.01.4042	15.7	15.01.4155	15.8	16.35.1004	16.2	16.62.6762	16.6
15.01.3040	15.6	15.01.4045	15.7	15.01.4159	15.8	16.35.1005	16.2	16.62.7233	16.7
15.01.3041	15.6	15.01.4046	15.7	15.01.5000	15.9	16.35.1006	16.2	16.63.1522	16.7
15.01.3042	15.6	15.01.4051	15.7	15.01.5004	15.9	16.35.1007	16.3	17.01.1004	17.7
15.01.3044	15.6	15.01.4052	15.7	15.01.6000	15.9	16.35.1008	16.4	17.01.1009	17.4
15.01.3121	15.6	15.01.4054	15.7	15.01.6500	15.4	16.35.1009	16.4	17.01.1009	17.7
15.01.3122	15.6	15.01.4057	15.7	15.01.6500	15.9	16.35.1010	16.2	17.01.1011	17.7
15.01.3125	15.6	15.01.4058	15.7	15.01.6501	15.9	16.35.1011	16.2	17.01.1016	17.4
15.01.3128	15.6	15.01.4060	15.7	15.01.7500	15.9	16.35.1012	16.3	17.01.1016	17.7
15.01.3129	15.6	15.01.4063	15.7	15.01.7503	15.9	16.35.1013	16.3	17.01.1016WC	17.8
15.01.3130	15.6	15.01.4068	15.7	15.01.7504	15.9	16.35.1014	16.3	17.01.1018	17.7
15.01.3131	15.6	15.01.4071	15.7	15.01.7509	15.9	16.35.1015	16.4	17.01.1018	17.8
15.01.3134	15.4	15.01.4072	15.7	15.01.7510	15.9	16.35.1016	16.4	17.01.1030	17.7
15.01.3134	15.6	15.01.4074	15.7	15.01.7511	15.9	16.35.1017	16.4	17.01.1031	17.7
15.01.3135	15.4	15.01.4075	15.7	15.01.8500	15.9	16.35.1018	16.3	17.01.1040	17.7
15.01.3135	15.6	15.01.4076	15.7	15.01.8501	15.9	16.35.1019	16.4	17.01.1041	17.7
15.01.3136	15.6	15.01.4087	15.4	15.01.8505	15.9	16.35.1020	16.4	17.01.1051	17.7
15.01.4000	15.7	15.01.4087	15.8	15.01.8507	15.9	16.35.1021	16.4	17.01.1051	17.8
15.01.4001	15.7	15.01.4088	15.8	15.01.8511	15.9	16.35.1022	16.5	17.01.1055	17.8
15.01.4002	15.7	15.01.4089	15.8	15.01.8513	15.9	16.35.1023	16.3	17.01.1058	17.8
15.01.4003	15.7	15.01.4090	15.8	15.01.8514	15.9	16.35.1024	16.5	17.01.1108	17.8
15.01.4004	15.7	15.01.4094	15.8	15.01.9001	15.10	16.35.1025	16.4	17.02.0023	17.11
15.01.4006	15.7	15.01.4096	15.8	15.01.9002	15.10	16.35.1026	16.3	17.02.0623	17.12
15.01.4007	15.7	15.01.4097	15.8	15.01.9003	15.10	16.35.1027	16.3	17.02.0623	27.4
15.01.4008	15.7	15.01.4098	15.8	15.01.9004	15.10	16.35.1028	16.3	17.02.1203	17.11
15.01.4009	15.7	15.01.4099	15.4	15.01.9005	15.10	16.35.1029	16.4	17.02.4381	17.6
15.01.4010	15.7	15.01.4099	15.8	15.01.9006	15.10	16.35.1030	16.2	17.02.8438	17.6
15.01.4011	15.4	15.01.4108	15.8	15.01.9500	15.10	16.35.1031	16.2	17.02.9150	17.6
15.01.4011	15.7	15.01.4109	15.8	15.01.A301	15.10	16.35.1031	16.5	17.02.9151	17.6
15.01.4012	15.4	15.01.4110	15.8	15.02.4413	15.4	16.35.1032	16.4	17.02.9152	17.6
15.01.4012	15.7	15.01.4111	15.8	15.02.4441	15.4	16.35.1033	16.5	17.02.9156	17.6
15.01.4013	15.7	15.01.4115	15.8	15.02.4470	15.4	16.35.1034	16.2	17.02.9159	17.6
15.01.4014	15.7	15.01.4117	15.8	15.02.5619	15.4	16.35.1035	16.5	17.03.1000	17.5

EBS Reference	Page	EBS Reference	Page	EBS Reference	Page	EBS Reference	Page	EBS Reference	Page
17.03.1001	17.5	18.01.3004	18.10	18.02.1440	18.3	20.01.1000	20.12	20.01.1064	20.13
17.03.1002	17.4	18.01.3006	18.10	18.02.1447	18.3	20.01.10000	20.5	20.01.1065	20.3
17.03.1003	17.4	18.01.3010	18.10	18.02.1448	18.3	20.01.10001	20.5	20.01.1065	20.13
17.03.1004	17.5	18.01.3011	18.10	18.02.1449	18.4	20.01.1001	20.12	20.01.1066	20.3
17.03.1005	17.5	18.01.3012	18.10	18.02.1452	18.4	20.01.1002	20.11	20.01.1067	20.11
17.03.1006	17.4	18.01.3014	18.10	18.02.1502	18.4	20.01.1003	20.11	20.01.1068	20.11
17.03.1007	17.4	18.01.3015	18.10	18.02.1503	18.4	20.01.1004	20.11	20.01.1069	20.11
17.03.1008	17.5	18.01.3016	18.10	18.02.1505	18.4	20.01.1005	20.11	20.01.1070	20.11
17.03.9401	17.26	18.01.3018	18.10	18.02.1506	18.4	20.01.1006	20.3	20.01.1071	20.7
17.03.9411	17.26	18.01.3019	18.10	18.02.1510	18.4	20.01.1007	20.3	20.01.1072	20.7
18.01.1000	18.7	18.01.3030	18.10	18.02.1516	18.4	20.01.1008	20.12	20.01.1073	20.8
18.01.1002	18.7	18.01.3037	18.10	18.02.1525	18.4	20.01.1010	20.6	20.01.1074	20.8
18.01.1005	18.7	18.01.3110	18.10	18.02.1526	18.4	20.01.1011	20.6	20.01.1075	20.8
18.01.1040	18.7	18.01.3119	18.11	18.02.1527	18.4	20.01.1012	20.7	20.01.1076	20.15
18.01.1041	18.7	18.01.3123	18.11	18.02.1528	18.4	20.01.1013	20.12	20.01.1077	20.15
18.01.1042	18.8	18.01.3125	18.11	18.02.1529	18.4	20.01.1014	20.7	20.01.1079	20.4
18.01.1045	18.8	18.01.3126	18.11	18.02.1534	18.4	20.01.1015	20.7	20.01.1080	20.8
18.01.1047	18.8	18.01.3137	18.11	18.02.1535	18.4	20.01.1016	20.12	20.01.1081	20.13
18.01.1082	18.8	18.01.3145	18.11	18.02.1560	18.4	20.01.1017	20.12	20.01.1082	20.8
18.01.1100	18.8	18.01.3150	18.11	18.02.1603	18.5	20.01.1019	20.12	20.01.1084	20.8
18.01.1101	18.8	18.01.3151	18.11	18.02.1604	18.5	20.01.1020	20.3	20.01.1085	20.8
18.01.1110	18.8	18.01.3152	18.11	18.02.1605	18.5	20.01.1021	20.7	20.01.1086	20.8
18.01.1122	18.8	18.01.3211	18.11	18.02.1608	18.5	20.01.1022	20.7	20.01.1087	20.8
18.01.1191	18.8	18.01.3320	18.11	18.02.1609	18.5	20.01.1023	20.13	20.01.1088	20.8
18.01.1192	18.8	18.01.3400	18.11	18.02.1610	18.5	20.01.1024	20.13	20.01.1089	20.8
18.01.1210	18.2	18.01.3401	18.11	18.02.1611	18.5	20.01.1025	20.13	20.01.1090	20.8
18.01.1210	18.8	18.01.3403	18.11	18.02.1612	18.5	20.01.1026	20.13	20.01.1091	20.8
18.01.1220	18.8	18.01.3730	18.11	18.02.1613	18.5	20.01.1027	20.13	20.01.1092	20.8
18.01.1221	18.8	18.01.3732	18.11	18.02.1615	18.5	20.01.1028	20.3	20.01.1093	20.9
18.01.1223	18.8	18.01.3740	18.11	18.02.1616	18.5	20.01.1029	20.13	20.01.1094	20.9
18.01.1240	18.8	18.01.4958	4.4	18.02.1620	18.5	20.01.1030	20.13	20.01.1095	20.9
18.01.1250	18.8	18.01.4958	18.7	18.02.1623	18.5	20.01.1031	20.13	20.01.1097	20.5
18.01.1252	18.8	18.01.6000	18.7	18.02.1625	18.5	20.01.1032	20.5	20.01.1098	20.5
18.01.1260	18.8	18.02.1158	18.2	18.02.1642	18.5	20.01.1033	20.5	20.01.1099	20.5
18.01.1261	18.8	18.02.1158	18.6	18.02.1643	18.6	20.01.1034	20.7	20.01.1100	20.5
18.01.1300	18.9	18.02.1162	18.2	18.02.1644	18.6	20.01.1035	20.3	20.01.1101	20.5
18.01.1302	18.9	18.02.1168	18.2	18.02.1645	18.6	20.01.1036	20.5	20.01.1102	20.5
18.01.1320	18.9	18.02.1170	18.2	18.02.1646	18.6	20.01.1037	20.11	20.01.1103	20.6
18.01.1322	18.9	18.02.1171	18.3	18.02.1648	18.6	20.01.1038	20.6	20.01.1104	20.6
18.01.1323	18.9	18.02.1178	18.3	18.02.1653	18.6	20.01.1039	20.11	20.01.1105	20.6
18.01.1330	18.9	18.02.1179	18.3	18.02.1654	18.6	20.01.1040	20.7	20.01.1106	20.6
18.01.1340	18.9	18.02.1183	18.3	18.02.1658	18.6	20.01.1041	20.7	20.01.1107	20.11
18.01.1342	18.9	18.02.1186	18.3	18.02.1800	18.6	20.01.1042	20.13	20.01.1108	20.11
18.01.1380	18.9	18.02.1188	18.3	18.02.2001	18.6	20.01.1043	20.6	20.01.1110	20.12
18.01.1381	18.9	18.02.1190	18.3	18.02.2002	18.6	20.01.1044	20.3	20.01.1111	20.4
18.01.1387	18.9	18.02.1191	18.3	18.02.2003	18.7	20.01.1045	20.6	20.01.1112	20.14
18.01.1388	18.9	18.02.1196	18.3	18.02.2004	18.7	20.01.1046	20.11	20.01.1113	20.14
18.01.1391	18.9	18.02.1404	18.3	18.02.2005	18.7	20.01.1052	20.7	20.01.1114	20.9
18.01.2002	18.9	18.02.1405	18.3	18.02.2006	18.7	20.01.1054	20.6	20.01.1116	20.9
18.01.2003	18.9	18.02.1407	18.3	18.02.2007	18.7	20.01.1057	20.13	20.01.1117	20.9
18.01.2004	18.9	18.02.1407	18.6	18.02.2008	18.7	20.01.1058	20.11	20.01.1118	20.2
18.01.2005	18.9	18.02.1408	18.3	18.02.3211	18.10	20.01.1059	20.7	20.01.1118	20.9
18.01.2006	18.9	18.02.1409	18.3	18.02.3211	18.11	20.01.1060	20.7	20.01.1119	20.9
18.01.2008	18.10	18.02.1427	18.3	18.03.1000	18.2	20.01.1061	20.7	20.01.1120	20.6
18.01.3001	18.10	18.02.1428	18.3	18.04.1000	18.2	20.01.1062	20.10	20.01.1121	20.6
18.01.3003	18.10	18.02.1437	18.3	18.37.1000	18.2	20.01.1063	20.13	20.01.1122	20.6

EBS Reference	Page	EBS Reference	Page	EBS Reference	Page	EBS Reference	Page	EBS Reference	Page
20.01.1123	20.6	21.01.3008	21.4	21.01.4400	21.5	21.03.3001	21.6	21.07.155F	21.4
20.01.1124	20.6	21.01.3022	21.4	21.01.5001	21.5	21.04.9014	21.2	21.07.156A	21.4
20.01.1126	20.5	21.01.3026	21.4	21.01.5004	21.3	21.04.9015	21.2	21.07.156B	21.4
20.01.1127	20.5	21.01.4000	21.4	21.01.5004	21.5	21.04.9017	21.2	21.07.156C	21.4
20.01.1128	20.5	21.01.4001	21.3	21.01.5005	21.5	21.04.9018	21.2	21.07.156D	21.4
20.01.1129	20.5	21.01.4001	21.4	21.01.5007	21.5	21.04.9019	21.2	21.07.156E	21.4
20.01.1130	20.4	21.01.4002	21.4	21.01.5008	21.5	21.04.9020	21.2	21.07.156E	21.5
20.01.1131	20.4	21.01.4003	21.4	21.01.5009	21.5	21.04.9021	21.2	21.07.157C	21.4
20.01.1132	20.4	21.01.4006	21.4	21.01.5010	21.5	21.04.9022	21.2	21.07.157G	21.4
20.01.1133	20.4	21.01.4008	21.4	21.01.5014	21.5	21.04.9023	21.2	21.07.157L	21.4
20.01.1134	20.4	21.01.4009	21.4	21.01.5015	21.5	21.04.9026	21.2	21.07.157M	21.4
20.01.1135	20.4	21.01.4010	21.4	21.01.5016	21.5	21.04.9027	21.3	21.07.157P	21.4
20.01.1136	20.12	21.01.4011	21.4	21.01.5018	21.5	21.04.9029	21.3	21.07.2114	21.3
20.01.1137	20.12	21.01.4012	21.4	21.01.5020	21.5	21.04.9030	21.3	21.07.2115	21.3
20.01.1138	20.12	21.01.4013	21.4	21.01.5026	21.5	21.04.9034	21.3	21.07.2116	21.3
20.01.1141	20.5	21.01.4014	21.4	21.01.5028	21.5	21.04.9036	21.3	21.07.2118	21.3
20.01.1141	20.6	21.01.4015	21.4	21.01.5029	21.5	21.04.9039	21.3	21.07.2121	21.3
20.01.1142	20.6	21.01.4016	21.4	21.01.5030	21.5	21.04.9047	21.3	21.07.2122	21.3
20.01.1143	20.9	21.01.4017	21.4	21.01.5031	21.5	21.04.9050	21.3	21.07.2123	21.3
20.01.1144	20.9	21.01.4021	21.5	21.01.5032	21.5	21.04.9055	21.3	21.09.1000	30.84
20.01.1145	20.9	21.01.4023	21.5	21.01.5033	21.5	21.04.9059	21.3	21.30.1000	21.3
20.01.1146	20.9	21.01.4024	21.5	21.01.5035	21.5	21.04.9061	21.3	21.30.1001	21.3
20.01.1147	20.9	21.01.4025	21.5	21.01.5036	21.5	21.04.9063	21.3	22.01.1020	1.13
20.01.1148	20.9	21.01.4026	21.3	21.01.5037	21.5	21.04.9069	21.3	22.01.1020	22.5
20.01.1149	20.10	21.01.4026	21.5	21.01.5039	21.5	21.04.9101	21.3	22.01.2000	22.5
20.01.1150	20.10	21.01.4027	21.5	21.01.5041	21.5	21.04.9102	21.3	22.01.2001	22.5
20.01.1151	20.10	21.01.4032	21.5	21.01.5045	21.5	21.06.1000	21.2	22.01.3020	22.2
20.01.1152	20.14	21.01.4200	21.5	21.01.5046	21.5	21.06.1001	21.2	22.01.3021	22.2
20.01.1153	20.14	21.01.4201	21.5	21.01.5048	21.5	21.06.1002	21.2	22.01.3022	22.2
20.01.1154	20.14	21.01.4300	21.5	21.01.5049	21.5	21.06.1003	21.2	22.01.3023	22.2
20.01.1155	20.14	21.01.4301	21.5	21.01.5060	21.5	21.06.1004	21.2	22.01.3024	22.2
20.01.1156	20.10	21.01.4302	21.5	21.01.5061	21.4	21.06.1005	21.2	22.01.3025	22.2
20.01.1157	20.10	21.01.4304	21.5	21.01.5063	21.5	21.06.1006	21.2	22.01.3026	22.2
20.01.1158	20.10	21.01.4305	21.5	21.01.5065	21.5	21.06.1007	21.2	22.01.3027	22.2
20.01.1159	20.6	21.01.4306	21.5	21.01.5068	21.5	21.06.1008	21.2	22.01.3028	22.2
20.01.1160	20.6	21.01.4307	21.5	21.01.5072	21.5	21.06.1009	21.2	22.01.3032	22.2
20.01.1161	20.10	21.01.4308	21.5	21.01.5073	21.5	21.06.1010	21.2	22.01.3033	22.2
20.01.1162	20.10	21.01.4309	21.5	21.01.5300	21.5	21.06.1011	21.2	22.01.3034	22.2
20.01.1166	20.10	21.01.4310	21.5	21.01.5400	21.5	21.06.1012	21.2	22.01.3035	22.2
20.01.1167	20.14	21.01.4311	21.5	21.01.5500	21.5	21.06.1013	21.2	22.01.3037	22.2
20.01.1168	20.14	21.01.4312	21.5	21.01.5501	21.5	21.06.1014	21.2	22.01.3039	22.2
20.01.1169	20.10	21.01.4313	21.5	21.01.5503	21.5	21.06.1015	21.2	22.01.3047	22.2
20.01.1170	20.10	21.01.4314	21.5	21.01.5512	21.5	21.06.1016	21.2	22.01.3048	22.2
20.03.1001	20.2	21.01.4315	21.5	21.01.6000	21.6	21.06.1017	21.2	22.01.3049	22.2
20.03.1003	20.2	21.01.4317	21.5	21.01.6001	21.6	21.06.1018	21.2	22.01.3051	22.2
20.03.1005	20.2	21.01.4318	21.5	21.01.6002	21.6	21.06.1019	21.2	22.01.3120	22.3
20.25.2000	20.2	21.01.4322	21.5	21.01.7001	21.6	21.06.1020	21.2	22.01.3122	22.3
20.27.1000	20.2	21.01.4324	21.5	21.01.7017	21.6	21.06.1021	21.2	22.01.3123	22.3
20.27.2000	20.2	21.01.4325	21.5	21.01.7071	21.6	21.06.1022	21.2	22.01.3124	22.3
20.29.2000	20.2	21.01.4328	21.5	21.01.8220	21.3	21.06.1023	21.2	22.01.3125	22.3
20.30.2000	20.3	21.01.4330	21.5	21.01.8226	21.3	21.06.1024	21.2	22.01.3126	22.3
20.30.2001	20.3	21.01.4331	21.5	21.01.9001	21.6	21.06.1025	21.2	22.01.3127	22.3
20.30.2002	20.3	21.01.4332	21.5	21.01.B004	21.3	21.06.1026	21.2	22.01.3128	22.3
21.01.3000	21.4	21.01.4333	21.5	21.02.1240	21.3	21.06.1028	21.2	22.01.3130	22.3
21.01.3004	21.4	21.01.4335	21.5	21.02.5118	21.3	21.06.1029	21.2	22.01.3131	22.3
21.01.3005	21.4	21.01.4339	21.5	21.02.5125	21.3	21.07.152D	21.4	22.01.3133	22.3

EBS Reference	Page	EBS Reference	Page	EBS Reference	Page	EBS Reference	Page	EBS Reference	Page
22.01.3134	22.3	22.03.1001	22.8	23.01.5001	23.13	23.06.1000	23.2	25.80.0023D	25.37
22.01.3136	22.3	22.03.1003	22.6	23.01.5003	23.13	23.06.1001	23.3	25.80.0024	25.37
22.01.3139	22.3	22.03.1004	22.6	23.01.6000	23.13	23.06.1002	23.2	25.80.0030	25.19
22.01.3143	22.3	22.04.1000	22.2	23.01.6001	23.13	23.06.1003	23.3	25.80.0041	25.36
22.01.3144	22.3	22.04.1001	22.2	23.01.6002	23.13	23.06.1004	23.3	25.80.0086	25.13
22.01.3153	22.3	22.04.1002	22.2	23.01.6004	23.13	23.06.1005	23.2	25.80.0108	25.32
22.01.3220	22.3	22.06.1000	22.3	23.01.6008	23.14	23.06.1006	23.3	25.80.0124	25.34
22.01.3221	22.3	22.06.1001	22.3	23.01.6009	23.14	23.06.1008	23.2	25.80.0125	25.34
22.01.3222	22.3	22.06.1002	22.3	23.01.6010	23.14	23.06.1009	23.2	25.80.0133	25.7
22.01.3223	22.3	22.06.1003	22.3	23.01.6011	23.14	23.06.1011	23.2	25.80.0134	25.32
22.01.3224	22.3	22.06.1004	22.3	23.01.6014	23.14	23.07.1000	23.3	25.80.0176	25.14
22.01.3225	22.3	22.06.1058	22.5	23.01.6050	23.14	23.07.1000	23.8	25.80.0177	25.14
22.01.3227	22.3	22.06.4000	22.6	23.01.6067	23.14	23.07.1001	23.8	25.80.0178	25.14
22.01.3228	22.3	22.08.1000	22.4	23.01.6100	23.14	23.07.1002	23.8	25.80.0179	25.14
22.01.3230	22.3	22.30.1000	22.4	23.01.6101	23.14	23.07.1003	23.8	25.80.0180	25.14
22.01.3232	22.3	23.01.1520	23.9	23.01.6105	23.14	23.07.1004	23.8	25.80.0181	25.14
22.01.3234	22.3	23.01.1531	23.9	23.01.6106	23.14	23.09.1000	23.4	26.01.2900	26.12
22.01.3235	22.3	23.01.2000	23.10	23.01.6107	23.14	23.37.1000	23.6	26.01.2910	26.12
22.01.3236	22.3	23.01.2150	23.5	23.01.6107	23.15	24.01.1025	24.4	26.01.2912	26.12
22.01.3240	22.3	23.01.2150	23.10	23.01.6109	23.15	24.01.1039	24.4	26.01.2913	26.13
22.01.3244	22.3	23.01.2152	23.5	23.01.6110	23.15	24.01.2020	24.4	26.01.B000	26.9
22.01.3246	22.3	23.01.2152	23.6	23.01.6200	23.15	24.01.2301	24.4	26.01.B020	26.9
22.01.3249	22.3	23.01.2152	23.10	23.01.6201	23.15	24.01.2314	24.4	26.01.B021	26.9
22.01.3253	22.3	23.01.2157	23.10	23.01.6203	23.15	24.01.2316	24.5	26.01.C020	26.9
22.01.3257	22.3	23.01.2200	23.10	23.01.6205	23.15	24.01.2500	24.5	26.01.C022	26.9
22.01.3505	22.3	23.01.2300	23.11	23.01.6206	23.15	24.01.3000	24.5	26.01.C023	26.9
22.01.3507	22.3	23.01.2301	23.11	23.01.6208	23.15	24.01.4000	24.5	26.01.C026	26.9
22.01.3600	22.3	23.01.2303	23.11	23.01.6250	23.15	24.01.4008	24.5	26.01.C120	26.9
22.01.4000	22.4	23.01.2304	23.11	23.01.6300	23.15	24.01.6000	24.5	26.01.C220	26.9
22.01.4100	22.4	23.01.2307	23.11	23.01.7000	23.8	24.01.7010	24.5	26.01.E000	26.10
22.01.5000	22.4	23.01.2308	23.11	23.01.7000	23.9	24.01.7012	24.5	26.01.E001	26.10
22.01.5009	22.4	23.01.2530	23.11	23.01.7001	23.9	24.01.7014	24.5	26.01.E010	26.10
22.01.5021	22.4	23.01.2531	23.11	23.01.8004	23.9	24.01.8402	24.5	26.01.E011	26.10
22.01.5027	22.4	23.01.2532	23.11	23.01.8005	23.9	24.01.9003	24.5	26.01.E031	26.10
22.01.5029	22.4	23.01.2533	23.11	23.01.8009	23.9	24.01.9004	2.19	26.01.E041	26.10
22.01.5050	22.4	23.01.2570	23.11	23.01.9001	23.10	24.01.9004	24.6	26.01.E100	26.10
22.01.5055	22.4	23.01.2620	23.11	23.01.9010	23.10	24.02.0195	24.3	26.01.G010	26.11
22.01.6003	22.6	23.01.2700	23.12	23.01.9103	23.10	24.02.0198	24.3	26.01.G011	15.3
22.01.7009	22.5	23.01.2701	23.12	23.01.9106	23.10	24.02.1399	24.3	26.01.G011	26.11
22.01.8028	22.9	23.01.2805	23.12	23.01.A001	23.10	24.02.5564	24.3	26.01.G012	26.11
22.01.8031	22.9	23.01.3010	23.5	23.02.1000	23.6	24.30.1000	24.4	26.01.G013	26.11
22.01.8034	22.9	23.01.3010	23.12	23.02.10001	4.5	24.30.1001	24.4	26.01.H012	23.19
22.01.8038	22.9	23.01.3020	23.4	23.02.10001	23.6	25.80.0000	25.19	26.01.H012	26.6
22.01.8039	22.9	23.01.3020	23.7	23.02.1001	23.6	25.80.0001	25.19	26.01.H012	26.11
22.01.8042	22.9	23.01.3020	23.12	23.03.1000	23.5	25.80.0008	25.19	26.01.H013	23.19
22.01.8045	22.10	23.01.3210	23.12	23.03.1001	23.5	25.80.0009	25.19	26.01.H013	26.11
22.01.8051	22.10	23.01.3211	23.12	23.03.1002	23.5	25.80.0010	25.19	26.01.H051	26.6
22.01.8053	22.10	23.01.3221	23.12	23.03.1003	23.5	25.80.0011	25.19	26.01.H051	26.12
22.01.8057	22.10	23.01.4000	23.12	23.04.1000	23.4	25.80.0014	25.19	26.01.H052	26.12
22.01.8059	22.10	23.01.4002	23.12	23.04.1001	23.4	25.80.0019	25.31	26.01.J001	26.12
22.01.9003	22.5	23.01.4006	23.13	23.04.1002	23.4	25.80.0020	25.34	26.01.J003	26.12
22.02.1000	22.2	23.01.4007	23.13	23.04.1003	23.4	25.80.0021	25.32	26.01.J005	26.12
22.02.1001	22.2	23.01.4008	23.13	23.04.1004	23.4	25.80.0022	25.36	26.01.J006	26.12
22.02.4146	22.4	23.01.4010	23.13	23.04.1005	23.4	25.80.0022D	25.35	26.01.K002	26.12
22.02.5131	22.4	23.01.4012	23.13	23.04.1007	23.4	25.80.0022D	25.36	26.01.M020	26.10
22.03.1000	22.2	23.01.5000	23.13	23.04.1008	23.4	25.80.0023	25.37	26.01.M023	26.10

EBS Reference	Page	EBS Reference	Page	EBS Reference	Page	EBS Reference	Page	EBS Reference	Page
26.01.M312	26.11	27.01.5013	27.11	29.21.3005	29.9	29.28.1086	29.6	30.01.1001	30.26
26.01.M316	26.11	27.01.5015	27.11	29.21.4002	29.9	29.28.1089	29.6	30.01.1001	30.35
26.02.1103	26.6	27.01.5016	27.11	29.21.4004	29.9	29.28.1110	29.6	30.01.1002	30.6
26.02.1122	26.6	27.01.5018	27.11	29.21.5001	29.10	29.28.1111	29.6	30.01.1002	30.10
26.02.1124	26.6	27.01.5022	27.11	29.21.5009	29.10	29.28.1112	29.6	30.01.1002	30.35
26.02.2111	26.7	27.01.5120	27.11	29.25.1000	29.3	29.28.1114	29.6	30.01.1003	30.6
26.02.2115	26.7	27.01.5300	27.11	29.25.1002	29.3	29.28.1117	29.6	30.01.1003	30.9
26.02.4311A	26.6	27.02.1000	27.3	29.25.1015	29.3	29.28.2011	29.8	30.01.1003	30.10
26.02.4311B	26.6	27.03.1001	27.2	29.25.1026	29.3	29.28.5004	29.10	30.01.1003	30.11
26.02.4370	26.6	27.04.1000	27.6	29.25.1028	29.3	29.29.1010	29.6	30.01.1003	30.12
26.03.1000	26.3	27.04.1001	27.6	29.25.1031	29.3	29.29.1011	29.6	30.01.1003	30.23
26.03.1000	26.9	27.04.1002	27.6	29.25.1034	29.3	29.29.1033	29.6	30.01.1003	30.26
26.03.1001	26.3	27.04.1003	27.6	29.25.1035	29.3	29.29.1038	29.6	30.01.1003	30.30
26.03.1002	26.5	27.04.1004	27.5	29.25.1058	29.4	29.29.1051	29.6	30.01.1003	30.31
26.03.1003	26.5	27.06.1000	27.4	29.25.1080	29.4	29.29.1052	29.6	30.01.1003	30.35
26.03.1004	26.5	27.06.1002	27.4	29.25.3001	29.9	29.29.1059	29.7	30.01.1004	30.7
26.03.1005	26.5	27.06.1003	27.4	29.25.5007	29.10	29.29.1069	29.7	30.01.1004	30.11
26.03.2001	26.3	27.06.1003	27.6	29.26.1005	29.4	29.29.1072	29.7	30.01.1004	30.20
26.03.2002	26.3	27.06.1004	27.4	29.26.1032	29.4	29.29.1073	29.7	30.01.1004	30.23
26.03.3001	26.5	27.06.1005	27.5	29.26.1041	29.4	29.29.1085	29.7	30.01.1004	30.31
26.03.3002	26.5	27.06.1006	27.6	29.26.1041	29.5	29.29.1109	29.7	30.01.1004	30.35
27.01.1110	27.7	27.07.1000	27.3	29.26.1050	29.4	29.29.2005	29.8	30.01.1005	30.11
27.01.2002	27.7	27.07.1001	27.3	29.26.1115	29.4	29.29.4003	29.9	30.01.1006	30.7
27.01.3000	27.7	27.07.1002	27.4	29.26.2001	29.8	29.29.4005	29.9	30.01.1006	30.30
27.01.3007	27.7	27.07.1003	27.3	29.26.4001	29.9	29.29.4006	29.9	30.01.1006	30.31
27.01.3013	27.8	27.07.1004	27.4	29.26.5005	29.10	29.29.4007	29.9	30.01.1006	30.35
27.01.3022	27.8	27.07.1005	27.4	29.26.5006	29.10	29.29.4012	29.9	30.01.1007	30.20
27.01.3070	27.8	27.07.1006	27.4	29.27.1003	29.4	29.30.1004	29.7	30.01.1008	30.7
27.01.3402	27.5	27.07.1007	27.4	29.27.1013	29.4	29.30.1012	29.7	30.01.1008	30.11
27.01.3402	27.8	29.21.1001	29.2	29.27.1017	29.4	29.30.1014	29.7	30.01.1008	30.13
27.01.3403	27.8	29.21.1007	29.2	29.27.1018	29.4	29.30.1023	29.7	30.01.1008	30.23
27.01.3406	27.8	29.21.1007	29.3	29.27.1025	29.4	29.30.1027	29.7	30.01.1009	30.20
27.01.3409	27.8	29.21.1008	29.2	29.27.1029	29.4	29.30.1039	29.7	30.01.1009	30.35
27.01.3422	27.8	29.21.1009	29.2	29.27.1042	29.5	29.30.1054	29.7	30.01.1010	30.7
27.01.3423	27.5	29.21.1019	29.2	29.27.1043	29.5	29.30.1061	29.7	30.01.1010	30.20
27.01.3423	27.9	29.21.1022	29.2	29.27.1053	29.4	29.30.1063	29.8	30.01.1011	30.20
27.01.3425	27.9	29.21.1024	29.2	29.27.1055	29.4	29.30.1081	29.8	30.01.1012	30.2
27.01.3450	27.9	29.21.1030	29.2	29.27.1056	29.5	29.30.1083	29.8	30.01.1012	30.11
27.01.3500	27.9	29.21.1037	29.2	29.27.1057	29.5	29.30.1090	29.8	30.01.1013	30.7
27.01.3501	27.9	29.21.1044	29.2	29.27.1068	29.5	29.30.1091	29.7	30.01.1013	30.26
27.01.3520	27.3	29.21.1045	29.2	29.27.1084	29.5	29.30.1108	29.8	30.01.1014	30.7
27.01.3520	27.9	29.21.1046	29.2	29.27.1088	29.5	29.30.1113	29.8	30.01.1014	30.20
27.01.3521	27.9	29.21.1047	29.2	29.27.3002	29.9	29.30.2002	29.8	30.01.1014	30.36
27.01.3521	27.10	29.21.1060	29.2	29.27.5002	29.10	29.30.2003	29.8	30.01.1015	30.13
27.01.3522	27.9	29.21.1064	29.2	29.27.5003	29.10	29.30.2004	29.8	30.01.1015	30.20
27.01.3523	27.9	29.21.1065	29.2	29.27.5008	29.10	29.30.4011	29.9	30.01.1015	30.37
27.01.3528	27.9	29.21.1066	29.3	29.28.1006	29.5	29.42.3003	29.9	30.01.1016	30.7
27.01.3532	27.9	29.21.1076	29.3	29.28.1016	29.5	29.43.1020	29.8	30.01.1017	30.23
27.01.3535	27.10	29.21.1077	29.3	29.28.1040	29.5	29.43.1021	29.8	30.01.1017	30.36
27.01.5001	27.10	29.21.1078	29.3	29.28.1062	29.5	30.01.1000	30.6	30.01.1018A/B	30.23
27.01.5002	27.10	29.21.1079	29.3	29.28.1067	29.5	30.01.1000	30.35	30.01.1018A/B	30.26
27.01.5005	27.10	29.21.1087	29.3	29.28.1070	29.5	30.01.10000	30.47	30.01.1018A/B	30.31
27.01.5006	27.3	29.21.1092	29.3	29.28.1071	29.5	30.01.1001	30.6	30.01.1018A/B	30.36
27.01.5006	27.10	29.21.1116	29.3	29.28.1074	29.5	30.01.1001	30.11	30.01.1020	30.24
27.01.5007	27.10	29.21.2003	29.8	29.28.1075	29.5	30.01.1001	30.12	30.01.1020	30.36
27.01.5010	27.10	29.21.3004	29.9	29.28.1082	29.6	30.01.1001	30.23	30.01.1021	30.26

EBS Reference	Page	EBS Reference	Page	EBS Reference	Page	EBS Reference	Page	EBS Reference	Page
30.01.1021	30.36	30.01.1049	30.38	30.01.1082A/B	30.32	30.01.1116	30.43	30.01.3111	30.47
30.01.1022A/B	30.24	30.01.1050	30.28	30.01.1082A/B	30.41	30.01.1117	30.19	30.01.3112	30.16
30.01.1022A/B	30.26	30.01.1050	30.38	30.01.1083A/B	30.25	30.01.1118	30.43	30.01.3112	30.47
30.01.1022A/B	30.36	30.01.1051	30.28	30.01.1083A/B	30.32	30.01.1119	30.33	30.01.3115	30.16
30.01.1023	30.27	30.01.1051	30.38	30.01.1083A/B	30.41	30.01.2500	30.44	30.01.3115	30.47
30.01.1023	30.36	30.01.1052	30.28	30.01.1084A/B	30.25	30.01.2550	30.44	30.01.3116	30.16
30.01.1024A/B	30.27	30.01.1052	30.38	30.01.1084A/B	30.32	30.01.2560	30.14	30.01.3116	30.47
30.01.1024A/B	30.36	30.01.1053	30.28	30.01.1084A/B	30.41	30.01.2560	30.44	30.01.3144	30.8
30.01.1025A/B	30.27	30.01.1053	30.38	30.01.1085	30.25	30.01.2580	30.44	30.01.3145	30.8
30.01.1025A/B	30.36	30.01.1054	30.28	30.01.1085	30.32	30.01.2590	30.12	30.01.3146	30.33
30.01.1026A/B	30.24	30.01.1054	30.38	30.01.1085	30.41	30.01.2590	30.44	30.01.3147	30.34
30.01.1026A/B	30.27	30.01.1055	30.28	30.01.1085A/B	30.25	30.01.2610	30.44	30.01.3148	30.34
30.01.1026A/B	30.31	30.01.1055	30.39	30.01.1088	30.13	30.01.2630	30.14	30.01.3149	30.34
30.01.1026A/B	30.37	30.01.1056A/B	30.28	30.01.1088	30.41	30.01.2630	30.44	30.01.3150	30.47
30.01.1027A/B	30.24	30.01.1056A/B	30.39	30.01.1089	30.13	30.01.2640	30.14	30.01.3151	30.47
30.01.1027A/B	30.31	30.01.1057A/B	30.24	30.01.1089	30.41	30.01.2640	30.44	30.01.4001	30.54
30.01.1027C/D	30.24	30.01.1057A/B	30.28	30.01.1093A/B	30.25	30.01.2650	30.14	30.01.4002	30.54
30.01.1027C/D	30.31	30.01.1057A/B	30.39	30.01.1093A/B	30.32	30.01.2650	30.44	30.01.4003	30.54
30.01.1029	30.2	30.01.1058	30.8	30.01.1093A/B	30.41	30.01.2660	30.14	30.01.4004	30.54
30.01.1029	30.6	30.01.1058	30.11	30.01.1094	30.9	30.01.2660	30.45	30.01.4006	30.54
30.01.1029	30.7	30.01.1058	30.39	30.01.1094	30.41	30.01.2670	30.45	30.01.4007	30.54
30.01.1029	30.11	30.01.1059C/D	30.29	30.01.1096	30.33	30.01.2680	30.14	30.01.4008	30.54
30.01.1029	30.20	30.01.1059C/D	30.39	30.01.1096	30.42	30.01.2690	30.14	30.01.6001	30.75
30.01.1029	30.24	30.01.1061	30.12	30.01.1097	30.33	30.01.2730	30.45	30.01.6002	30.75
30.01.1029	30.32	30.01.1062	30.13	30.01.1097	30.42	30.01.2770	30.45	30.01.6013	30.75
30.01.1029	30.37	30.01.1062	30.39	30.01.1098	30.42	30.01.2780	30.45	30.01.6015	30.75
30.01.1030A/B	30.27	30.01.1063	30.13	30.01.1099	30.22	30.01.2790	30.45	30.01.6017	30.75
30.01.1030A/B	30.32	30.01.1063	30.39	30.01.1099	30.42	30.01.2880	30.14	30.01.6019	30.75
30.01.1030A/B	30.37	30.01.1064	30.32	30.01.1100	30.8	30.01.2880	30.45	30.01.6020	30.75
30.01.1031	30.20	30.01.1064	30.39	30.01.1100	30.42	30.01.2890	30.14	30.01.6021	30.75
30.01.1031	30.37	30.01.1068	30.24	30.01.1101	30.33	30.01.2890	30.45	30.01.6025	30.76
30.01.1032	30.20	30.01.1068	30.39	30.01.1101	30.42	30.01.2900	30.15	30.01.6029	30.76
30.01.1033	30.13	30.01.1069	30.24	30.01.1102	30.33	30.01.2900	30.45	30.01.6102	30.76
30.01.1033	30.21	30.01.1069	30.40	30.01.1102	30.42	30.01.2910	30.15	30.01.6104	30.76
30.01.1035	30.8	30.01.1070	30.13	30.01.1103C/D	30.33	30.01.2910	30.46	30.01.7001	30.74
30.01.1035	30.21	30.01.1070	30.40	30.01.1103C/D	30.42	30.01.2920	30.15	30.02.1010	30.61
30.01.1036	30.21	30.01.1071	30.13	30.01.1104	30.33	30.01.2920	30.46	30.03.1001	30.6
30.01.1037	30.21	30.01.1071	30.40	30.01.1104	30.42	30.01.2930	30.15	30.03.1001	30.9
30.01.1041	30.8	30.01.1072	30.29	30.01.1105	30.33	30.01.2930	30.46	30.03.1001	30.10
30.01.1041	30.37	30.01.1072	30.40	30.01.1105	30.43	30.01.2940	30.15	30.03.1001	30.11
30.01.1042	30.8	30.01.1073	30.63	30.01.1106	30.30	30.01.2940	30.46	30.03.1001	30.12
30.01.1042	30.11	30.01.1074	30.63	30.01.1106	30.43	30.01.2960	30.15	30.03.1001	30.23
30.01.1042	30.37	30.01.1075	30.29	30.01.1107	30.12	30.01.2960	30.46	30.03.1001	30.26
30.01.1043	30.21	30.01.1075	30.40	30.01.1107	30.22	30.01.2970	30.15	30.03.1001	30.30
30.01.1044	30.8	30.01.1076	30.29	30.01.1107	30.43	30.01.2970	30.46	30.03.1001	30.31
30.01.1044	30.37	30.01.1076	30.40	30.01.1108	30.12	30.01.2980	30.15	30.03.1001	30.35
30.01.1045	30.27	30.01.1077	30.29	30.01.1108	30.22	30.01.2980	30.46	30.03.1001	30.48
30.01.1045	30.37	30.01.1077	30.40	30.01.1108	30.43	30.01.2990	30.15	30.03.1002	30.6
30.01.1046	30.27	30.01.1078	30.29	30.01.1109A/B	30.30	30.01.2990	30.46	30.03.1002	30.7
30.01.1046	30.38	30.01.1078	30.40	30.01.1110	30.22	30.01.3001	30.26	30.03.1002	30.10
30.01.1047	30.27	30.01.1079	30.29	30.01.1110	30.43	30.01.3001	30.46	30.03.1002	30.35
30.01.1047	30.38	30.01.1079	30.40	30.01.1111A/B	30.30	30.01.3107	30.16	30.03.1002	30.48
30.01.1048	30.2	30.01.1080	30.32	30.01.1112	30.43	30.01.3107	30.47	30.04.10000	30.48
30.01.1048	30.27	30.01.1081	30.9	30.01.1113	30.43	30.01.3108	30.16	30.04.10001	30.48
30.01.1048	30.38	30.01.1081	30.41	30.01.1114	30.22	30.01.3108	30.47	30.04.1004	30.16
30.01.1049	30.28	30.01.1082A/B	30.25	30.01.1115	30.22	30.01.3111	30.16	30.04.1005	30.16

EBS Reference	Page	EBS Reference	Page	EBS Reference	Page	EBS Reference	Page	EBS Reference	Page
30.04.1008	30.2	30.04.1042	30.18	30.11.2001	30.53	30.26.2017	30.76	30.27.2029	30.82
30.04.1009	30.2	30.04.1043	30.5	30.11.2002	30.53	30.26.2018	30.76	30.27.2030	30.82
30.04.1009	30.25	30.04.1043	30.18	30.11.2003	30.53	30.26.2019	30.76	30.27.2031	30.82
30.04.1009	30.48	30.04.1044	30.5	30.11.2004	30.52	30.26.2020	30.76	30.27.2031	34.11
30.04.1010	30.2	30.04.1044	30.18	30.11.2020	30.53	30.26.2021	30.76	30.27.2032	30.56
30.04.1010	30.25	30.04.1045	30.5	30.11.3000	30.30	30.26.2022	30.77	30.27.2032	34.10
30.04.1010	30.48	30.04.1045	30.19	30.11.4000	30.34	30.26.2023	30.77	30.27.2033	30.56
30.04.1014	30.2	30.04.1046	30.5	30.11.5003	30.52	30.26.2024	30.60	30.27.2033	34.10
30.04.1014	30.16	30.04.1046	30.19	30.11.5018	30.52	30.26.2025	30.77	30.27.2034	30.68
30.04.1015	30.2	30.04.1047	30.5	30.11.5023	30.52	30.26.2026	30.77	30.27.2035	30.65
30.04.1015	30.17	30.04.1047	30.34	30.11.5030	30.52	30.26.2027	30.77	30.27.2036	30.65
30.04.1016	30.2	30.04.1048	30.5	30.11.5040	30.53	30.26.2028	30.77	30.27.2037	30.78
30.04.1016	30.17	30.04.1048	30.19	30.11.5080	30.53	30.26.2029	30.77	30.27.2038	30.56
30.04.1017	30.2	30.04.1049	30.25	30.11.5100	30.53	30.26.2030	30.77	30.27.4001	30.60
30.04.1017	30.17	30.04.1050	30.25	30.21.10002	30.75	30.26.2031	30.77	30.27.4003	30.60
30.04.1018	30.3	30.04.1051	30.19	30.21.2000	30.61	30.26.2032	30.78	30.28.2000	30.68
30.04.1018	30.29	30.04.1052	30.19	30.21.2001	30.55	30.26.2033	30.81	30.28.2001	30.62
30.04.1019	30.3	30.04.1053A/B	30.5	30.21.2002	30.80	30.26.2034	30.56	30.28.2002	30.79
30.04.1021	30.3	30.04.1054	30.5	30.21.2003	30.61	30.26.2035	30.67	30.28.2003	30.65
30.04.1021	30.9	30.04.1054	30.30	30.21.2004	30.80	30.26.2036	30.81	30.28.2004	30.68
30.04.1021	30.23	30.04.1056	30.12	30.21.2005	30.64	30.26.2037	30.56	30.28.2005	30.71
30.04.1022	30.3	30.04.1057	30.5	30.21.2006	30.67	30.26.2038	30.56	30.28.2006	30.71
30.04.1022	30.34	30.04.2000	30.61	30.21.2007	30.73	30.26.2039	30.78	30.28.2007	30.68
30.04.1023	30.3	30.04.2001	30.61	30.21.2008	30.64	30.26.2040	30.81	30.28.2008	30.65
30.04.1024	30.3	30.04.2002	30.54	30.21.2009	30.71	30.26.2041	30.64	30.28.2009	30.68
30.04.1024	30.9	30.04.2003	30.54	30.21.2010	30.71	30.26.2042	30.81	30.28.2010	30.66
30.04.1025	30.3	30.04.2004	30.73	30.21.2012	30.73	30.26.2043	30.67	30.28.2010	30.66
30.04.1025	30.22	30.04.2005	30.48	30.21.2013	30.79	30.27.0001	30.22	30.28.2011	30.66
30.04.1026	30.3	30.04.3001	30.73	30.21.2014	30.64	30.27.10000	30.65	30.28.2012	30.66
30.04.1027	30.3	30.04.4001	30.63	30.21.2015	30.64	30.27.2000	30.67	30.29.1000	30.68
30.04.1028	30.12	30.05.2000	5.17	30.21.2016	30.55	30.27.2001	30.60	30.29.10000	30.72
30.04.1029	30.3	30.05.2000	30.54	30.21.2017	30.80	30.27.2002	30.60	30.29.2000	30.79
30.04.1029	30.17	30.05.2001	5.17	30.21.2018	30.80	30.27.2003	30.60	30.29.2001	30.68
30.04.1030	30.4	30.05.2001	30.55	30.21.2019	30.55	30.27.2004	30.78	30.29.2002	30.69
30.04.1030	30.17	30.10.0001	30.61	30.21.2020	30.64	30.27.2005	30.64	30.29.2003	30.56
30.04.1031	30.4	30.10.0002A	5.21	30.25.2000	30.67	30.27.2006	30.61	30.29.2004	30.56
30.04.1031	30.17	30.10.0002A	5.23	30.25.2001	30.80	30.27.2007	30.64	30.29.2005	30.69
30.04.1032	30.4	30.10.0002A	30.71	30.25.2002	30.80	30.27.2008	30.68	30.29.2006	30.69
30.04.1032	30.17	30.10.0003	30.55	30.25.2003	30.80	30.27.2009	30.68	30.29.2008	30.71
30.04.1033	30.4	30.10.0004	30.80	30.26.10001	30.63	30.27.2010	30.62	30.29.2009	30.71
30.04.1033	30.17	30.10.0005	30.22	30.26.2000	30.61	30.27.2011	30.62	30.29.2010	30.69
30.04.1034	30.4	30.10.0006	30.22	30.26.2001	30.61	30.27.2012	30.64	30.29.2011	30.73
30.04.1034	30.17	30.10.0007	30.55	30.26.2002	30.61	30.27.2014	30.56	30.29.2012	17.9
30.04.1035A/B	30.4	30.11.0080	30.50	30.26.2003	30.61	30.27.2015	30.78	30.29.2012	30.51
30.04.1035A/B	30.29	30.11.0180	30.50	30.26.2004	30.55	30.27.2016	30.65	30.29.2013	30.71
30.04.1036	30.4	30.11.0230	30.50	30.26.2005	30.80	30.27.2017	30.65	30.29.2014	30.79
30.04.1036	30.18	30.11.0300	30.50	30.26.2006	30.55	30.27.2018	30.65	30.29.2015	30.71
30.04.1037	30.4	30.11.0380	30.50	30.26.2007	30.81	30.27.2019	30.62	30.29.2016	30.79
30.04.1037	30.18	30.11.0400	30.50	30.26.2008	30.64	30.27.2020	30.60	30.29.2017	30.57
30.04.1038	30.18	30.11.0510	30.50	30.26.2009	30.67	30.27.2021	30.56	30.29.2018	30.57
30.04.1039	30.18	30.11.0600	30.50	30.26.2010	30.55	30.27.2022	30.81	30.29.2019	30.69
30.04.1040	30.4	30.11.0800	30.50	30.26.2011	30.79	30.27.2023	30.68	30.29.2020	30.66
30.04.1040	30.18	30.11.1000	30.50	30.26.2012	30.67	30.27.2024	30.65	30.29.2021	30.72
30.04.1041	30.4	30.11.10008	25.41	30.26.2013	30.67	30.27.2026	30.81	30.29.2022	30.69
30.04.1041	30.18	30.11.10008	30.53	30.26.2015	30.55	30.27.2027	30.81	30.29.2023	30.82
30.04.1042	30.5	30.11.2000	30.53	30.26.2016	30.67	30.27.2028	30.81	30.29.2024	30.82

EBS Reference	Page	EBS Reference	Page	EBS Reference	Page	EBS Reference	Page	EBS Reference	Page
30.29.2025	30.82	30.30.2036	30.70	30.38.1003	34.4	30.72.1500	17.25	7616	2.25
30.29.2026	30.69	30.30.2037	30.72	30.38.1004	34.2	30.73.0900	17.25	7617	2.25
30.29.2027	30.85	30.30.2038	30.72	30.38.1005	34.2	30.73.1000	17.25	7618	2.25
30.29.2028	30.82	30.30.2039	30.84	30.38.1006	34.3	30.73.1200	17.25	7868T	2.25
30.29.2029	30.78	30.30.2040	30.84	30.38.1007	34.3	30.73.1300	17.25	90.00.1000	90.4
30.29.2030	30.82	30.30.2041	30.84	30.38.1008	34.2	30.73.1400	17.25	90.00.1001	90.5
30.29.2031	30.73	30.30.2042	30.84	30.38.1009	34.4	30.73.1500	17.25	90.00.1002	90.4
30.29.2032	30.72	30.30.2043	30.58	30.38.1010	34.2	30.99.0000	30.51	90.00.1003	90.4
30.29.2033	30.66	30.30.2044	30.58	30.38.1011	34.7	30.99.0001	30.51	90.01.1000	90.3
30.29.2034	30.82	30.30.2045	30.58	30.38.1011	34.6	30.99.0002	30.51	90.01.10000	9.18
30.29.2035	30.78	30.30.2046	30.58	30.38.1012	34.7	30.99.0003	30.51	90.01.1002	90.3
30.29.2036	30.62	30.30.2047	30.58	30.38.1013	34.7	30.99.0004	30.52	90.01.1004	90.3
30.29.2037	30.62	30.30.2048	30.58	30.38.1014	34.6	30.99.0005	30.52	90.01.1005	90.3
30.29.2038	30.79	30.30.2049	30.58	30.38.1015	34.6	30.99.0006	30.52	90.01.1009	90.3
30.29.2039	30.79	30.30.2050	30.58	30.38.1016	34.4	30.99.0007	30.52	90.01.1012	90.3
30.29.2041	30.63	30.30.2051	30.58	30.38.1017	34.4	30.99.0008	30.52	90.01.2012	90.9
30.29.2042	30.73	30.30.2052	30.58	30.38.1018	34.4	34.21.5001	34.10	90.01.2015	90.9
30.29.2043	30.83	30.30.2053	30.59	30.38.1019	34.2	34.21.7001	34.9	90.01.2017	90.9
30.29.2044	30.72	30.30.2054	30.59	30.38.1020	34.6	34.21.7002	34.9	90.01.2018	90.9
30.30.1000	30.62	30.30.2055	30.59	30.38.1020	34.7	34.21.7003	34.9	90.01.2050	15.13
30.30.10000	30.72	30.30.2056	30.59	30.38.1021	34.5	34.21.8001	34.8	90.01.2050	15.14
30.30.10001	30.57	30.30.2057	30.59	30.38.1022	34.2	34.21.9001	34.8	90.01.2050	23.19
30.30.10003	30.57	30.30.2058	30.59	30.38.1023	34.2	34.21.9002	34.8	90.01.2050	90.9
30.30.2000	30.57	30.30.2059	30.59	30.38.1024	34.4	34.25.10000	34.9	90.01.2060	90.9
30.30.2001	30.69	30.30.2060	30.72	30.38.1025	34.4	34.25.7001	34.9	90.01.2070	90.9
30.30.2003	30.83	30.30.2061	30.84	30.38.1026	34.3	34.25.7002	34.9	90.01.2202	9.22
30.30.2004	30.83	30.30.2062	30.59	30.38.1027	34.3	34.27.4000	34.11	90.01.2202	90.9
30.30.2005	30.83	30.30.2063	30.74	30.38.1028	34.2	34.27.5001	34.10	90.01.2913	90.9
30.30.2006	30.83	30.30.2065	30.72	30.38.1029	34.4	34.27.6001	34.8	90.01.3003	90.4
30.30.2007	30.83	30.30.2066	30.70	30.38.1030	34.5	34.27.9001	34.8	90.01.3107	90.4
30.30.2008	30.62	30.30.2067	30.59	30.38.1031	34.5	34.28.7001	34.9	90.01.3132	90.4
30.30.2010	30.57	30.30.2068	30.84	30.38.1032	34.5	34.28.7002	34.9	90.01.3133	90.4
30.30.2011	30.70	30.30.2069	30.74	30.38.1033	34.5	34.29.4000	34.11	90.01.4000	90.2
30.30.2012	30.70	30.30.2070	30.57	30.38.1034	34.2	34.29.7001	34.9	90.01.4001	90.2
30.30.2013	30.62	30.30.2071	30.57	30.38.1035	34.4	34.30.1000	34.10	90.01.4002	90.2
30.30.2014	30.62	30.30.2072	30.59	30.38.1036	34.2	34.30.1001	34.10	90.01.4003	90.2
30.30.2015	30.70	30.30.2073	30.66	30.38.1037	34.7	34.30.1002	34.10	90.01.4004	90.2
30.30.2016	30.66	30.30.2074	30.84	30.38.1038	34.7	34.30.2000	34.11	90.01.4005	90.2
30.30.2017	30.83	30.30.2075	30.84	30.38.1039	34.3	34.30.4000	34.11	90.01.9000	90.12
30.30.2018	30.83	30.30.2076	30.66	30.38.1040	34.3	34.30.4001	34.11	90.01.9001	90.12
30.30.2019	30.83	30.30.2077	30.85	30.38.1041	34.3	34.30.4002	34.11	90.01.9002	90.12
30.30.2020	30.84	30.30.2078	30.85	30.38.1042	34.3	34.30.4003	34.11	90.01.9003	90.12
30.30.2022	30.73	30.30.2079	30.85	30.38.1043	34.3	34.30.7001	34.9	90.02.1001	90.2
30.30.2023	30.74	30.30.2080	30.85	30.38.1044	34.3	34.30.7002	34.8	90.02.1002	90.2
30.30.2024	30.74	30.30.2081	30.69	30.38.2001	34.5	34.30.9002	34.8	90.02.1003	90.2
30.30.2025	30.74	30.30.2082	30.70	30.38.2002	34.5	34.30.9003	34.8	90.02.1004	90.2
30.30.2026	30.74	30.30.2083	30.85	30.38.2003	34.5	4711	2.25	90.02.1005	90.2
30.30.2027	30.74	30.30.2086	30.63	30.38.2004	34.5	4713	2.25	90.02.1006	90.2
30.30.2028	30.70	30.30.2088	30.63	30.38.2005	34.5	4759	2.25	90.02.1007	90.2
30.30.2029	30.62	30.30.2089	30.72	30.38.2006	34.6	4760	2.25	90.02.1008	90.2
30.30.2030	30.70	30.30.2090	30.85	30.38.2007	34.6	7604	2.25	90.02.1009	90.3
30.30.2031	30.66	30.38.1000	34.6	30.38.2008	34.6	7606	2.25	90.02.1011	90.3
30.30.2032	30.57	30.38.10000	34.6	30.38.2009	34.6	7611	2.25	90.02.2000	90.3
30.30.2032C	30.57	30.38.10001	34.6	30.38.2010	34.6	7613G	2.25	90.02.2001	90.3
30.30.2033	30.58	30.38.1001	34.7	30.72.1200	17.24	7614	2.25	90.02.2002	90.3
30.30.2035	30.63	30.38.1002	34.4	30.72.1300	17.25	7615	2.25	90.02.2003	90.3

EBS Reference	Page	EBS Reference	Page	EBS Reference	Page	EBS Reference	Page	EBS Reference	Page
90.02.2004	90.3	90.30.1000	31.7	EBS.9031.G2	3.23	EBS2070	25.12	EBS2442F	1.11
90.02.2005	90.3	90.30.10000	90.9	EBS.9031.G3	3.23	EBS2075	25.12	EBS2452F	1.11
90.04.1000	90.9	90.30.1001	31.7	EBS.9031.G4	3.23	EBS2080	25.12	EBS2475	25.11
90.04.1001	90.9	90.30.1002	31.7	EBS.9031.G5	3.23	EBS2085	25.10	EBS2480	25.11
90.06.3731	90.12	90.30.1003	31.7	EBS.BENCH.01	90.13	EBS2090	25.12	EBS2505	25.20
90.20.1000	31.2	90.30.1004	31.7	EBS.BENCH.02	90.14	EBS2095	25.12	EBS2510	25.20
90.20.1001	31.2	90.30.1005	31.7	EBS.BENCH.03	90.14	EBS2100	25.15	EBS2515	25.6
90.20.1002	31.2	90.30.1006	31.7	EBS1000	25.33	EBS2105	25.5	EBS2540	25.29
90.20.1003	31.2	90.30.1007	31.7	EBS1005	25.31	EBS2110	25.5	EBS2545	25.29
90.20.1004	31.2	90.30.2000	90.9	EBS1010	25.31	EBS2115	25.5	EBS2575	25.29
90.20.1005	31.2	90.30.5000	90.12	EBS1015	25.37	EBS2120	25.5	EBS2580	25.29
90.20.1006	31.2	90.30.5000.C	90.12	EBS1020	25.32	EBS2125	25.5	EBS2585	25.26
90.20.1007	31.2	90.36.1000	31.6	EBS1025	25.33	EBS2130	25.15	EBS2590	25.26
90.20.1008	31.2	90.36.1001	31.6	EBS1025	25.37	EBS2135	25.15	EBS2595	25.26
90.21.1000	31.3	90.444	90.12	EBS1030	25.34	EBS2140	25.16	EBS2610	25.12
90.21.1001	31.3	C1001	6.22	EBS1034F	1.10	EBS2150	25.16	EBS2615	25.12
90.21.1002	31.3	C1001	6.26	EBS1035	25.34	EBS2155	25.16	EBS2620	25.12
90.21.1003	31.3	C1001	6.28	EBS1040	25.34	EBS2160	25.16	EBS2625	25.12
90.21.1004	31.3	C1001	6.37	EBS1055	25.33	EBS2170	25.8	EBS2630	25.21
90.21.1005	31.3	C1002	6.27	EBS1059F	1.10	EBS2196F	1.11	EBS2635	25.21
90.222	90.12	C1003	6.27	EBS1065	25.33	EBS2207F	1.11	EBS2640	25.21
90.24.1000	31.3	CRANK-GEAR1	6.41	EBS1075	25.35	EBS2210	25.25	EBS2645	25.21
90.24.1001	31.3	CRANK-GEAR10	6.41	EBS1080	25.35	EBS2215	25.25	EBS2655	25.11
90.24.1002	31.3	CRANK-GEAR11	6.41	EBS1085	25.33	EBS2220	25.25	EBS2700	25.14
90.24.1003	31.3	CRANK-GEAR12	6.41	EBS1090	25.33	EBS2227F	1.11	EBS2710	25.26
90.24.1004	31.3	CRANK-GEAR13	6.41	EBS1110	25.35	EBS2230	25.21	EBS2715	25.16
90.24.1005	31.3	CRANK-GEAR14	6.27	EBS1115	25.35	EBS2232F	1.10	EBS2720	25.16
90.25.1001	31.4	CRANK-GEAR14	6.41	EBS1120	25.35	EBS2232F	1.11	EBS2725	25.6
90.25.1002	31.4	CRANK-GEAR2	6.41	EBS1125	25.31	EBS2235	25.8	EBS2730	25.6
90.25.1003	31.4	CRANK-GEAR3	6.41	EBS1130	25.35	EBS2240	25.21	EBS2735	25.26
90.26.1000	31.4	CRANK-GEAR4	6.41	EBS1135	25.35	EBS2249	25.25	EBS2740	25.26
90.26.1001	31.4	CRANK-GEAR5	6.11	EBS1137	25.37	EBS2250	25.25	EBS2745	25.9
90.26.1001.K	31.4	CRANK-GEAR5	6.41	EBS1160	25.35	EBS2260	25.25	EBS2750	25.16
90.26.1001.S	31.4	CRANK-GEAR6	6.41	EBS1170	25.33	EBS2262F	1.11	EBS2755	25.17
90.26.1002	31.4	CRANK-GEAR7	6.41	EBS1180	25.33	EBS2265	25.25	EBS2775	25.28
90.26.1003	31.4	CRANK-GEAR8	6.41	EBS1270	25.32	EBS2270	25.25	EBS2780	25.28
90.27.1000	31.4	CRANK-GEAR9	6.4	EBS1315	25.33	EBS2275	25.28	EBS2785	25.30
90.27.10000	31.5	CRANK-GEAR9	6.41	EBS1320	25.32	EBS2280	25.28	EBS2788	25.34
90.27.1001	31.4	CRANK-NUT1	6.39	EBS1325	25.32	EBS2282F	1.11	EBS2790	25.30
90.27.1002	31.5	CRANK-NUT2	6.39	EBS1330	25.35	EBS2285	25.28	EBS2795	25.21
90.27.1003	31.5	CRANK-NUT3	6.39	EBS1335	25.36	EBS2290	25.28	EBS2800	25.21
90.27.1004	31.5	CRANK-NUT4	6.39	EBS1507F	1.11	EBS2295	25.28	EBS2815	25.21
90.27.1005	31.5	DRA01	90.10	EBS1507F	1.12	EBS2300	25.29	EBS2816	25.6
90.27.1006	31.5	DRA01.V.1	90.10	EBS1605E	25.36	EBS2305	25.5	EBS2820	25.22
90.27.1007	31.5	DRA02HDL	90.10	EBS2010	25.4	EBS2310	25.14	EBS2905	25.22
90.27.1008	31.5	DRA03	90.10	EBS2015	25.4	EBS2355	25.11	EBS2910	25.22
90.27.1009	31.5	DRA07T	90.10	EBS2020	25.4	EBS2360	25.25	EBS2920	25.22
90.27.1010	31.5	DRA08	90.10	EBS2025	25.4	EBS2365	25.11	EBS2925	25.22
90.27.1011	31.5	EBS.012	2.3	EBS2030	25.4	EBS2390	25.11	EBS2930	25.17
90.28.1000	31.6	EBS.9031	3.23	EBS2035	25.5	EBS2400	25.5	EBS2940	25.22
90.29.1000	31.6	EBS.9031.0T	3.23	EBS2040	25.15	EBS2405	25.9	EBS2945	25.22
90.29.1001	31.6	EBS.9031.1	3.23	EBS2045	25.15	EBS2410	25.9	EBS2955	25.20
90.29.1002	31.6	EBS.9031.2	3.23	EBS2050	25.15	EBS2415	25.9	EBS2975	25.10
90.29.1003	31.6	EBS.9031.3	3.23	EBS2055	25.15	EBS2420	25.16	EBS3005	25.6
90.29.1004	31.6	EBS.9031.3.A	3.23	EBS2060	25.15	EBS2425	25.5	EBS3030	25.28
90.29.1005	31.6	EBS.9031.ADP	3.23	EBS2065	25.15	EBS2440	25.16	EBS3035	25.28

EBS Reference	Page	EBS Reference	Page	EBS Reference	Page	EBS Reference	Page	EBS Reference	Page
EBS3040	25.22	EBS3710	25.29	ECKB.11	3.10	ECKH.3	3.14	ECKK.16.6.1-PT/1	3.22
EBS3045	25.22	EBS3755	25.24	ECKB.13.1	3.10	ECKH.4	3.14	ECKK.16.6-PT	3.22
EBS3050	25.23	EBS3790	25.7	ECKB.13.2	3.10	ECKH.5	3.14	ECKK.16.6-PT/1	3.22
EBS3055	25.23	EBS3795	25.17	ECKB.15	3.10	ECKH.5.1	3.14	ECKK.16.7	3.22
EBS3085	25.23	EBS3800	25.18	ECKB.15.1	3.10	ECKH.6	3.14	ECKK.16.7-PT	3.22
EBS3090	25.23	EBS3805	25.29	ECKB.15.2	3.10	ECKH.7	3.14	ECKK.16.7-PT/1	3.22
EBS3115	25.13	EBS3810	25.30	ECKB.15.3	3.10	ECKH.8	3.14	ECKK.16-PT	3.21
EBS3120	25.13	EBS3815	25.18	ECKB.17	3.10	ECKH.9	3.14	ECKK.17	3.19
EBS3125	25.17	EBS3820	25.18	ECKB.18	3.10	ECKH.9.1	3.14	ECKK.17.1	3.19
EBS3130	25.17	EBS3825	25.24	ECKB.18.B	3.10	ECKK.1	3.16	ECKK.17.2	3.19
EBS3135	25.29	EBS3830	25.24	ECKB.20	3.10	ECKK.1.	3.16	ECKK.17.3	3.19
EBS3140	25.29	EBS3840	25.24	ECKB.3	3.10	ECKK.1.1	3.16	ECKK.17.4	3.19
EBS3145	25.17	EBS3845	25.24	ECKB.3.1	3.10	ECKK.1.2	3.16	ECKK.17.B	3.19
EBS3150	25.17	EBS3900	25.10	ECKB.3.3	3.10	ECKK.1.6	3.16	ECKK.17.C	3.19
EBS3155	25.17	EBS3910	25.30	ECKB.4	3.10	ECKK.10.1	3.18	ECKK.17.P	3.19
EBS3165	25.13	EBS3915	25.30	ECKB.5	3.10	ECKK.10.2	3.18	ECKK.18	3.20
EBS3170	25.14	EBS3950	25.20	ECKB.5.1	3.10	ECKK.10.3	3.18	ECKK.18	3.28
EBS3195	25.23	EBS3965	25.27	ECKB.7.12	3.10	ECKK.10.4	3.18	ECKK.18.1	3.20
EBS3200	25.23	EBS3970	25.27	ECKBR.1.1	3.11	ECKK.10.5	3.18	ECKK.18.10	3.20
EBS3205	25.23	EBS4010	25.18	ECKBR.1.14	3.11	ECKK.10.7	3.19	ECKK.18.11	3.20
EBS3210	25.29	EBS4015	25.18	ECKBR.1.2PK	3.11	ECKK.10.79	3.17	ECKK.18.12	3.20
EBS3255	25.10	EBS4135	25.8	ECKBR.1.3PK	3.11	ECKK.10.8	3.19	ECKK.18.13	3.20
EBS3260	25.10	EBS4170	25.18	ECKG.1.1	3.12	ECKK.10.80	3.17	ECKK.18.2	3.20
EBS3265	25.13	EBS4200	25.24	ECKG.1.2	3.12	ECKK.10.9	3.19	ECKK.18.3	3.20
EBS3270	25.13	EBS4215	25.8	ECKG.2	3.12	ECKK.11	3.19	ECKK.18.4	3.20
EBS3295	25.30	EBS4255	25.30	ECKH.1	3.13	ECKK.11.1	3.19	ECKK.18.5	3.20
EBS3300	25.8	EBS4260	25.30	ECKH.1.10	3.13	ECKK.12	3.19	ECKK.18.6	3.20
EBS3315	25.26	EBS4305	25.7	ECKH.1.11	3.13	ECKK.12.1	3.19	ECKK.18.7	3.20
EBS3320	25.26	EBS4315	25.27	ECKH.1.12	3.13	ECKK.13.2C	3.18	ECKK.18.8	3.20
EBS3335	25.13	EBS4320	25.27	ECKH.1.14	3.13	ECKK.13.3	3.18	ECKK.18.9	3.20
EBS3340	25.13	EBS4415	25.18	ECKH.1.14.1	3.13	ECKK.13.3B	3.18	ECKK.2.5	3.23
EBS3400	25.13	EBS4420	25.18	ECKH.1.14.2	3.13	ECKK.13.4C	3.18	ECKK.2.5.1	3.23
EBS3425	25.6	EBS4500	25.18	ECKH.1.15	3.15	ECKK.13.6C	3.18	ECKK.2.7	3.23
EBS3430	25.6	EBS4525F	1.11	ECKH.1.17	3.14	ECKK.13.7C	3.18	ECKK.2.8	3.18
EBS3460	25.8	EBS6003F	90.12	ECKH.1.18	3.15	ECKK.13.1	3.17	ECKK.21	3.23
EBS3480	25.17	EBS6383F	1.12	ECKH.1.2	3.13	ECKK.13.1.2	3.17	ECKK.21.1	3.23
EBS3485	25.23	EBS6837F	1.11	ECKH.1.21	3.9	ECKK.13.1.3	3.23	ECKK.21.2	3.23
EBS3490	25.23	EBS6968F	1.10	ECKH.1.21	3.14	ECKK.14	3.20	ECKK.22	3.17
EBS3495	25.9	EBS7624F	1.11	ECKH.1.3	3.13	ECKK.14.1	3.20	ECKK.22.1	3.17
EBS3520	25.26	EBS7794F	1.10	ECKH.1.4	3.13	ECKK.14.2	3.20	ECKK.22.5	3.17
EBS3522F	1.10	EBS8367F	90.12	ECKH.1.6	3.13	ECKK.14.3	3.20	ECKK.3.3	3.17
EBS3525	25.27	EBS8964F	1.10	ECKH.1.7	3.13	ECKK.15	3.20	ECKK.3.4	3.17
EBS3540	25.27	EBS9272F	1.11	ECKH.1.8	3.13	ECKK.16	3.21	ECKK.3.5	3.17
EBS3545	25.27	EBS9455F	1.12	ECKH.1.9	3.13	ECKK.16.1.R	3.21	ECKK.3.6	3.17
EBS3550	25.27	EBS9683	25.24	ECKH.1.2	3.15	ECKK.16.1.R-PT	3.21	ECKK.3.7	3.17
EBS3555	25.27	EBS9684	25.24	ECKH.1.4	3.15	ECKK.16.1.R-PT/1	3.21	ECKK.3.E	3.16
EBS3575	25.10	EBS9792	25.36	ECKH.1.4.1	3.15	ECKK.16.2	3.21	ECKK.4	3.18
EBS3645	25.9	EBS9793	25.36	ECKH.1.7	3.15	ECKK.16.2-PT	3.21	ECKK.4.2	3.18
EBS3650	25.9	EBSK.9031	3.23	ECKH.1.7.2	3.14	ECKK.16.2-PT/1	3.21	ECKK.4.3	3.18
EBS3655	25.7	EBSTEBSA	17.11	ECKH.1.8	3.15	ECKK.16.2-PT/2	3.22	ECKK.4.4	3.18
EBS3660	25.7	EBSVCS2A	17.2	ECKH.1.9	3.14	ECKK.16.3	3.22	ECKK.5	3.17
EBS3665	25.7	EBSVCS2B	17.2	ECKH.2	3.14	ECKK.16.4-PT	3.22	ECKK.5	3.19
EBS3680	25.10	ECJK.28	5.24	ECKH.2.1	3.14	ECKK.16.5	3.22	ECKK.6.1	3.16
EBS3685	25.10	ECJK.28.1	5.24	ECKH.2.12	3.14	ECKK.16.5-PT	3.22	ECKK.6.1A	3.16
EBS3700	25.7	ECJK.28.2	5.24	ECKH.2.12	3.15	ECKK.16.6	3.22	ECKK.6.20	3.9
EBS3705	25.7	ECKB.1	3.10	ECKH.2.21	3.9	ECKK.16.6.1	3.22	ECKK.6.21	3.9

EBS Reference	Page	EBS Reference	Page	EBS Reference	Page	EBS Reference	Page	EBS Reference	Page
ECKK.6.2C	3.16	ECKM.2.F	3.28	ECKM.3.3B	3.32	ECKM.6.20	3.12	ECKM.98.3	3.32
ECKK.6.3	3.16	ECKM.2.GR	3.27	ECKM.3.3B	3.34	ECKM.6.3	3.12	ECKM.98.3	3.34
ECKK.6.31	3.9	ECKM.2.H	3.29	ECKM.3.3B	3.35	ECKM.7	3.41	ECKM.98.3	3.40
ECKK.6.4	3.16	ECKM.2.J	3.29	ECKM.3.3B	3.40	ECKM.71.C	3.35	ECKP.1	3.12
ECKK.6.40	3.9	ECKM.2.K	3.29	ECKM.3.4	3.32	ECKM.710	3.35	ECKS.002	3.12
ECKK.6.41	3.9	ECKM.2.PL	3.29	ECKM.3.5	3.30	ECKM.711.1	3.36	ECKS.003	3.12
ECKK.6.42	3.9	ECKM.2.PR	3.29	ECKM.3.7	3.32	ECKM.711.2	3.36	ECKS.004	3.12
ECKK.6.43	3.9	ECKM.2.S	3.27	ECKM.3.9	3.32	ECKM.711.3	3.31	ECKS.017	3.11
ECKK.6.44	3.9	ECKM.20	3.28	ECKM.3.9	3.36	ECKM.711.3	3.39	ECKS.018	3.11
ECKK.6.45	3.9	ECKM.20.2	3.28	ECKM.3.9	3.39	ECKM.711.4	3.31	ECKS.022	3.11
ECKK.6.46	3.9	ECKM.21	3.9	ECKM.3.0	3.35	ECKM.711.4	3.39	ECKS.023	3.11
ECKK.6.47	3.9	ECKM.21	3.29	ECKM.4.2	3.30	ECKM.712	3.30	ECKS.025	3.11
ECKK.7	3.17	ECKM.21.1	3.27	ECKM.4.4	3.32	ECKM.712	3.35	ECKS.026	3.11
ECKK.7.1	3.17	ECKM.21.2	3.27	ECKM.4.4.12	3.36	ECKM.712	3.38	ECKS.027	3.11
ECKK.7.12	3.23	ECKM.23	3.33	ECKM.4.4.12	3.40	ECKM.713	3.36	ECKS.028	3.11
ECKK.7.D	3.16	ECKM.24	3.25	ECKM.4.4.20	3.9	ECKM.713	3.37	ECKS.029	3.11
ECKK.8	3.19	ECKM.24.1	3.25	ECKM.4.4.20	3.37	ECKM.713	3.38	ECKS.037	3.11
ECKK.8.1	3.16	ECKM.24.11	3.26	ECKM.4.4.21	3.37	ECKM.714	3.40	ECKW.1	3.47
ECKM.1	3.24	ECKM.24.12	3.26	ECKM.4.4.32	3.9	ECKM.714.2	3.40	ECKW.10	3.43
ECKM.10	3.41	ECKM.24.2	3.25	ECKM.4.4.32	3.37	ECKM.715	3.38	ECKW.10000	3.9
ECKM.10.2	3.42	ECKM.24.2	3.26	ECKM.4.4.33	3.37	ECKM.716	3.35	ECKW.10001	3.9
ECKM.11.1	3.42	ECKM.24.3	3.25	ECKM.46	3.38	ECKM.718	3.36	ECKW.10002	3.9
ECKM.11.2	3.42	ECKM.24.4	3.24	ECKM.5	3.33	ECKM.718	3.39	ECKW.10003	3.9
ECKM.11.3	3.42	ECKM.24.5	3.25	ECKM.5.10	3.34	ECKM.719	3.37	ECKW.11	3.43
ECKM.11.4	3.42	ECKM.24.6	3.25	ECKM.5.11	3.34	ECKM.72	3.35	ECKW.12	3.44
ECKM.11.5	3.42	ECKM.24.7	3.25	ECKM.5.12	3.34	ECKM.72	3.38	ECKW.12	3.46
ECKM.11.6	3.42	ECKM.24.8	3.24	ECKM.5.13	3.33	ECKM.720	3.9	ECKW.12	3.47
ECKM.11.P	3.42	ECKM.24.9	3.24	ECKM.5.14	3.34	ECKM.720	3.40	ECKW.12.1	3.44
ECKM.11.V	3.42	ECKM.24.C	3.25	ECKM.5.15	3.34	ECKM.721	3.36	ECKW.12.2	3.44
ECKM.12.1	3.42	ECKM.25	3.25	ECKM.5.16	3.33	ECKM.721	3.39	ECKW.12.3	3.44
ECKM.12.2	3.42	ECKM.25.1	3.25	ECKM.5.16	3.35	ECKM.729	3.37	ECKW.12.3	3.46
ECKM.12.V	3.42	ECKM.25.3	3.25	ECKM.5.16	3.38	ECKM.73	3.36	ECKW.12.4	3.43
ECKM.13	3.41	ECKM.25.4	3.24	ECKM.5.16	3.41	ECKM.730	3.37	ECKW.12.4	3.45
ECKM.14	3.42	ECKM.25.5	3.26	ECKM.5.17	3.34	ECKM.731	3.9	ECKW.12.CB	3.46
ECKM.15	3.42	ECKM.26	3.38	ECKM.5.17	3.41	ECKM.732	3.9	ECKW.17.1	3.43
ECKM.15.1	3.42	ECKM.27	3.26	ECKM.5.18A	3.34	ECKM.738	3.9	ECKW.17.2	3.43
ECKM.16.1	3.12	ECKM.27.1	3.26	ECKM.5.18B	3.34	ECKM.73C	3.35	ECKW.17.3	3.44
ECKM.18	3.31	ECKM.28	3.26	ECKM.5.18C	3.34	ECKM.74	3.36	ECKW.17.5	3.44
ECKM.18	3.36	ECKM.29	3.26	ECKM.5.2	3.31	ECKM.74	3.39	ECKW.18.11	3.49
ECKM.18	3.39	ECKM.3.1	3.30	ECKM.5.2	3.33	ECKM.75	3.39	ECKW.19.1	3.45
ECKM.18.1	3.37	ECKM.3.10	3.31	ECKM.5.21	3.34	ECKM.75C	3.39	ECKW.19.2	3.46
ECKM.18.1	3.39	ECKM.3.11	3.31	ECKM.5.3	3.31	ECKM.76	3.36	ECKW.19.3	3.46
ECKM.19	3.28	ECKM.3.12	3.31	ECKM.5.3	3.33	ECKM.76	3.39	ECKW.19.45	3.9
ECKM.19.1	3.28	ECKM.3.13	3.31	ECKM.5.4	3.33	ECKM.77	3.36	ECKW.19.46	3.9
ECKM.19.2	3.28	ECKM.3.14	3.30	ECKM.5.5	3.33	ECKM.77	3.39	ECKW.19.47	3.9
ECKM.19.3	3.28	ECKM.3.16	3.30	ECKM.5.6	3.33	ECKM.776	3.39	ECKW.19.48	3.9
ECKM.19.92	3.28	ECKM.3.17	3.30	ECKM.5.7	3.33	ECKM.78	3.39	ECKW.19.49	3.9
ECKM.19.93	3.28	ECKM.3.18	3.30	ECKM.5.9	3.34	ECKM.79	3.36	ECKW.19.5	3.46
ECKM.2	3.27	ECKM.3.19	3.37	ECKM.5.2.3	3.32	ECKM.8	3.27	ECKW.19.50	3.9
ECKM.2.1	3.27	ECKM.3.19	3.38	ECKM.54	3.41	ECKM.8.13	3.40	ECKW.19.51	3.9
ECKM.2.36	3.28	ECKM.3.2	3.30	ECKM.56.10	3.31	ECKM.8.G	3.27	ECKW.19.52	3.9
ECKM.2.37	3.28	ECKM.3.20	3.31	ECKM.56.2	3.32	ECKM.9.1	3.29	ECKW.19.FL	3.46
ECKM.2.B	3.27	ECKM.3.3	3.32	ECKM.56.3	3.32	ECKM.9.2	3.29	ECKW.2	3.43
ECKM.2.C	3.27	ECKM.3.3	3.34	ECKM.56.7	3.32	ECKM.98	3.30	ECKW.21	3.44
ECKM.2.D	3.27	ECKM.3.3	3.35	ECKM.6	3.24	ECKM.98.1	3.32	ECKW.22	3.46
ECKM.2.E	3.28	ECKM.3.3	3.40	ECKM.6.20	3.9	ECKM.98.2	3.32	ECKW.22	3.47

EBS Reference	Page	EBS Reference	Page	EBS Reference	Page	EBS Reference	Page	EBS Reference	Page
ECKW.22.1	3.49	EKBE.14.CR	6.31	EKBE.64.9	1.10	EKBO.2.15	6.38	EKBO.4	9.19
ECKW.22.10	3.50	EKBE.14.CRB.STD	6.31	EKBE.64.9A	1.15	EKBO.2.15.CS	6.38	EKBO.47	2.26
ECKW.22.11	3.50	EKBE.14.CRS	6.31	EKBE.64.9B	1.15	EKBO.2.15.CP	6.38	EKBO.48	2.26
ECKW.22.16-PT	3.50	EKBE.14.CS	6.31	EKBE.65.1	23.17	EKBO.2.16	6.35	EKBO.49	2.26
ECKW.22.2	3.49	EKBE.14.CSB	6.31	EKBE.65.2	23.17	EKBO.2.16	6.33	EKBO.5	9.19
ECKW.22.4	3.49	EKBE.14.CSB.STD	6.31	EKBE.65.3	9.19	EKBO.2.16.CH	6.35	EKBO.5.1	9.19
ECKW.22.5	3.49	EKBE.14.CSW	6.31	EKBE.71	23.17	EKBO.2.16.CH	6.33	EKBO.5.2	9.19
ECKW.22.6	3.50	EKBE.14.P.STD	6.31	EKBE.76	6.13	EKBO.2.17	6.39	EKBO.5.4	9.19
ECKW.22.7	3.50	EKBE.14.R.STD	6.31	EKBE.87.1	6.13	EKBO.2.17.CP	6.39	EKBO.5.6	9.19
ECKW.22.8	3.50	EKBE.14.RP.STD	6.31	EKBE.87.CH	6.13	EKBO.2.17.CR	6.39	EKBO.5.7	12.12
ECKW.22.9	3.50	EKBE.15	6.30	EKBE.87.G	6.13	EKBO.2.17.W	6.39	EKBO.5.8	21.6
ECKW.23.1	3.50	EKBE.15.3	6.30	EKBI.1	5.24	EKBO.2.18	6.38	EKBO.5.9C	9.19
ECKW.23.10	3.50	EKBE.19.RP.STD	6.30	EKBI.2	5.24	EKBO.2.18.CH	6.38	EKBO.54.1	12.12
ECKW.23.11	3.50	EKBE.24	22.10	EKBI.3.C	5.24	EKBO.2.18.CP	6.38	EKBO.54.2	12.12
ECKW.23.7	3.50	EKBE.27.10	6.13	EKBI.3.C2	5.24	EKBO.2.19	6.35	EKBO.54.3	12.12
ECKW.23.8	3.50	EKBE.27.10A	6.13	EKBI.3.C3	5.24	EKBO.2.19.CH	6.35	EKBO.57.3	23.17
ECKW.23.9	3.50	EKBE.27.11	6.13	EKBI.3.C3	5.24	EKBO.2.4	6.33	EKBO.58.1	17.26
ECKW.23.L.C	3.50	EKBE.27.11A	6.13	EKBI.3.C3	5.24	EKBO.2.4	6.34	EKBO.58.2	17.26
ECKW.23.R.C	3.50	EKBE.27.3	6.13	EKBI.3.C3	5.24	EKBO.2.4	6.35	EKBO.58.3	17.26
ECKW.24.1	3.46	EKBE.27.5P	6.13	EKBI.3.C3	5.24	EKBO.2.7	6.37	EKBO.58CAP.A	17.26
ECKW.24.10	3.48	EKBE.27.6	6.13	EKBI.3.C3	5.24	EKBO.2.8	6.37	EKBO.58CAP.B	17.26
ECKW.24.11	3.48	EKBE.27.7	6.13	EKBI.3.C3	5.24	EKBO.2.9	6.38	EKBO.58CAP.C	17.26
ECKW.24.12	3.48	EKBE.27.8	6.13	EKBI.3.C3	5.24	EKBO.2.9.W	6.39	EKBO.6	16.8
ECKW.24.3	3.48	EKBE.28	6.13	EKBI.3.C3	5.24	EKBO.2.9.CP	6.38	EKBO.6.3	1.15
ECKW.24.4	3.48	EKBE.3	6.30	EKBI.3.C3	5.24	EKBO.2.A	6.36	EKBO.6.3.1	1.15
ECKW.24.5	3.47	EKBE.30.RP	6.13	EKBI.3.C3	5.24	EKBO.2.A	6.34	EKBO.6.3.2.3	1.14
ECKW.24.6	3.47	EKBE.30.RP.STD	6.13	EKBI.3.C3	5.24	EKBO.2.A.CH	6.36	EKBO.6.3.4	1.15
ECKW.24.7	3.48	EKBE.37.1	11.5	EKBI.3.C3	5.24	EKBO.2.A.CH	6.34	EKBO.7.12AM	2.26
ECKW.24.9	3.48	EKBE.38	2.26	EKBI.3.C3	5.24	EKBO.2.BR	6.33	EKBO.7.2	2.26
ECKW.26.8	3.50	EKBE.38.3	2.26	EKBI.3.C3	5.24	EKBO.2.BR	6.34	EKBO.8.1	18.12
ECKW.4	3.45	EKBE.39.14	2.25	EKBI.3.C3	5.24	EKBO.2.BR	6.35	EKBO.9	11.5
ECKW.5	3.45	EKBE.39.38	2.25	EKBI.3.C3	5.24	EKBO.2.BR	6.36	EKBO.9.1	11.5
ECKW.5.1	3.45	EKBE.39.4	2.25	EKBI.3.C3	5.24	EKBO.2.BU	6.33	EKBP.011	3A.3
ECKW.5.CAP	3.45	EKBE.39.4	2.26	EKBI.3.C3	5.24	EKBO.2.BU	6.34	EKBP.013	3A.3
ECKW.6	3.45	EKBE.39.7	2.26	EKBI.3.C3	5.24	EKBO.2.BU	6.35	EKBP.026	3A.3
ECKW.6.20	3.9	EKBE.39.7	2.27	EKBI.3.C3	5.24	EKBO.2.BU	6.36	EKBP.030	3A.3
ECKW.6.21	3.9	EKBE.39.7C	2.26	EKBI.3.C3	5.24	EKBO.2.BU	6.37	EKBP.032	3A.3
ECKW.7	3.43	EKBE.39.7C	2.27	EKBI.3.C3	5.24	EKBO.218	6.37	EKBP.043	3A.3
ECKW.8	3.43	EKBE.39.B	2.26	EKBI.3.C3	5.24	EKBO.2C	6.35	EKBP.067	3A.3
ECKW.9	3.47	EKBE.43	23.17	EKBI.3.C3	5.24	EKBO.2C	6.34	EKBP.077	3A.3
EE4106	1.13	EKBE.45	23.17	EKBI.3.C3	5.24	EKBO.2C	6.33	EKBP.087	3A.3
EE4115	1.13	EKBE.45.C	23.17	EKBI.3.C3	5.24	EKBO.2C.CH	6.35	EKBP.088	3A.3
EKAOS.8	32.2	EKBE.46	23.17	EKBI.3.C3	5.24	EKBO.2C.CH	6.32	EKBP.090	3A.3
EKBE.1	6.30	EKBE.46.1	23.17	EKBI.3.C3	5.24	EKBO.2C.CH	6.33	EKBP.095	3A.3
EKBE.11.RP.STD	6.30	EKBE.48	9.19	EKBI.3.C3	5.24	EKBO.2C.DIM	6.35	EKBP.099	3A.3
EKBE.12	6.30	EKBE.49	9.19	EKBI.3.C3	5.24	EKBO.2C.DIM	6.33	EKBP.115	3A.3
EKBE.120.1	6.13	EKBE.50	9.19	EKBI.3.C3	5.24	EKBO.3	14.17	EKBP.121	3A.3
EKBE.120.2	6.13	EKBE.50.C	9.19	EKBI.3.C3	5.24	EKBO.3.1	14.17	EKBP.122	3A.3
EKBE.120.6	6.13	EKBE.50.TC	9.19	EKBI.3.C3	5.24	EKBO.3.2	14.17	EKBP.122	3A.4
EKBE.13	6.30	EKBE.51	9.19	EKBI.3.C3	5.24	EKBO.3.3	14.17	EKBP.123	3A.4
EKBE.14	6.31	EKBE.52.C	9.19	EKBI.3.C3	5.24	EKBO.3.4	14.17	EKBP.124	3A.4
EKBE.14.1	6.31	EKBE.58	15.12	EKBI.3.C3	5.24	EKBO.31	8.9	EKBP.125	3A.4
EKBE.14.2	6.31	EKBE.62	1.15	EKBI.3.C3	5.24	EKBO.31.1	13.9	EKBP.126	3A.4
EKBE.14.3	6.31	EKBE.64	1.15	EKBI.3.C3	5.24	EKBO.31.1A	13.9	EKBP.131	3A.4
EKBE.14.CB	6.31	EKBE.64.10	1.15	EKBI.3.C3	5.24	EKBO.31.2	13.9	EKBP.136	3A.4
EKBE.14.CH	6.31	EKBE.64.11	1.15	EKBI.3.C3	5.24	EKBO.32	8.9	EKBP.137	3A.4

EBS Reference	Page	EBS Reference	Page	EBS Reference	Page	EBS Reference	Page	EBS Reference	Page
EKBP.142	3A.4	EKCD.3.L	6.32	EKGH.22.1	26.13	EKKB.103.75	6.7	EKKB.131.4	6.15
EKBP.143	3A.4	EKCD.5.1	9.20	EKGH.22.1.J	26.13	EKKB.103.89.CH	6.7	EKKB.131.6	6.6
EKBP.151	3A.4	EKCD.5.4A	9.20	EKGH.22.1.K	26.13	EKKB.103.9	6.7	EKKB.131.6	6.8
EKBP.158	3A.4	EKCD.5.6	9.20	EKGH.22.1.L	26.13	EKKB.103.CHO	6.7	EKKB.131.6	6.16
EKBP.160	3A.4	EKCD.5.7	9.20	EKGH.22.2	26.13	EKKB.103.G	6.7	EKKB.131.7	6.6
EKBP.162	3A.4	EKCD.54	12.12	EKGH.22.3	26.13	EKKB.103.GB	6.7	EKKB.131.7	6.8
EKBP.165	3A.4	EKCD.6	5.22	EKGH.26	14.17	EKKB.103.RP.STD	6.6	EKKB.131.7	6.16
EKBP.167	3A.4	EKCD.6	5.24	EKGH.28.1	5.24	EKKB.103.RP.STD	6.7	EKKB.14.1	1.16
EKBP.169	3A.5	EKCD.8.1	11.5	EKGH.3	15.12	EKKB.104	6.8	EKKB.14.3	1.16
EKBP.171	3A.5	EKCD.8.2	11.5	EKGH.31	26.13	EKKB.104.CH	6.8	EKKB.2	12.12
EKBP.173	3A.5	EKDI.28.ID	5.24	EKGH.34	23.17	EKKB.104.RP	6.17	EKKB.2.9G.BU	6.14
EKBP.174	3A.5	EKFA.1	16.8	EKGH.45.1	9.20	EKKB.104.RP.STD	6.7	EKKB.21	26.14
EKBP.181	3A.5	EKFA.1.1	16.8	EKGH.46	23.17	EKKB.104.RP.STD	6.8	EKKB.22.C	26.14
EKBP.187	3A.5	EKFA.10	16.8	EKGH.51.3	18.12	EKKB.104.RP.STD	6.17	EKKB.23.1	10.10
EKBP.192	3A.5	EKFA.11	16.8	EKGH.57.2	17.27	EKKB.104.RP.STD	6.19	EKKB.23.2	10.10
EKBP.195	3A.5	EKFA.12	16.8	EKGH.57.6	17.27	EKKB.105	6.6	EKKB.23.2A	10.10
EKBP.195.A	3A.5	EKFA.13	16.8	EKGH.57.FK	17.27	EKKB.106	6.7	EKKB.25.75	5.25
EKBP.200	3A.5	EKFA.14	16.8	EKGH.57.K	17.27	EKKB.106.CH	6.7	EKKB.25.75C	5.25
EKBP.211	3A.5	EKFA.15	16.8	EKGH.58.2	27.12	EKKB.106.CK	6.7	EKKB.28	5.20
EKBP.227	3A.5	EKFA.16	16.9	EKGH.58.4	27.12	EKKB.106.CK	6.8	EKKB.28.1	5.20
EKBP.227	3A.6	EKFA.17	16.9	EKGH.59.1	17.27	EKKB.106.CP	6.7	EKKB.28.2	5.20
EKBP.227.A	3A.5	EKFA.18	16.9	EKGH.6	6.2	EKKB.108	6.17	EKKB.28.3C	5.20
EKBP.228	3A.5	EKFA.19	16.9	EKGH.61.1	11.5	EKKB.108.CH	6.17	EKKB.28.6	5.20
EKBP.228	3A.6	EKFA.2	16.8	EKGH.64.8	1.16	EKKB.108.CP	6.17	EKKB.28.6.1	5.20
EKBP.228	3A.7	EKFA.20	16.9	EKGH.64.9	1.16	EKKB.109	6.18	EKKB.29.1	14.18
EKBP.228.A	3A.5	EKFA.21	16.9	EKGH.65.1	1.12	EKKB.109.C	6.18	EKKB.29.2C	14.18
EKBP.229	3A.6	EKFA.21.1	16.9	EKGH.65.1	1.16	EKKB.109.CH	6.18	EKKB.3.3	18.12
EKBP.231	3A.6	EKFA.22	16.9	EKGH.65.2	1.16	EKKB.109.CP	6.18	EKKB.3.4	18.12
EKBP.232	3A.6	EKFA.23	16.9	EKGH.22.3	26.13	EKKB.109.TC	6.18	EKKB.3.6	18.12
EKBP.245	3A.6	EKFA.24	16.9	EKKB.10	2.27	EKKB.11	26.14	EKKB.308.CH	6.6
EKBP.246	3A.6	EKFA.25	16.9	EKKB.100	6.4	EKKB.11.1	2.27	EKKB.308.CH	6.8
EKBP.253	3A.6	EKFA.26	16.9	EKKB.100	6.5	EKKB.11.2	2.27	EKKB.31.1	13.9
EKBP.256	3A.6	EKFA.27	16.9	EKKB.100.1	6.5	EKKB.11.6	2.27	EKKB.31.2	13.9
EKBP.256	3A.7	EKFA.3	16.8	EKKB.100.1	6.34	EKKB.110	6.7	EKKB.31.2.S	13.9
EKBP.267	3A.6	EKFA.30	16.9	EKKB.100.19	6.7	EKKB.110.32	17.8	EKKB.38	2.27
EKBP.271	3A.5	EKFA.31	16.9	EKKB.100.2	6.5	EKKB.110.CH	6.7	EKKB.39	2.27
EKBP.271	3A.6	EKFA.32	16.9	EKKB.100.2CHO	6.5	EKKB.110.CP	6.7	EKKB.4	23.18
EKBP.279	3A.6	EKFA.33	16.9	EKKB.100.3	6.5	EKKB.114	6.6	EKKB.4.6	23.18
EKBP.284	3A.6	EKFA.34	16.9	EKKB.100.4	6.8	EKKB.114.CH	6.6	EKKB.42	15.12
EKBP.328	3A.6	EKFA.35	16.9	EKKB.100.BU	6.4	EKKB.120.2	6.15	EKKB.427.5.CH	6.4
EKBP.331	3A.6	EKFA.36	16.9	EKKB.100.BU	6.5	EKKB.122.1	6.15	EKKB.427.5.CH	6.34
EKBP.332	3A.6	EKFA.37	16.9	EKKB.100.BU	6.6	EKKB.122.2	6.13	EKKB.428.9.CH	6.38
EKBP.340	3A.6	EKFA.4	16.8	EKKB.100.CH	6.5	EKKB.122.2	6.14	EKKB.44	15.12
EKBP.345	3A.7	EKFA.40	16.9	EKKB.10000	6.8	EKKB.123.1	6.15	EKKB.44.2	15.12
EKBP.484	3A.7	EKFA.41	16.9	EKKB.10004	9.20	EKKB.130	6.4	EKKB.45	9.20
EKBP.485	3A.7	EKFA.5	16.8	EKKB.101	6.8	EKKB.130	6.5	EKKB.45.1	9.20
EKBP.486	3A.7	EKFA.6	16.8	EKKB.101.BU	6.8	EKKB.130.2	6.14	EKKB.46	9.20
EKBP.576	3A.7	EKFA.7	16.8	EKKB.101.CR	6.8	EKKB.130.3	6.14	EKKB.46.1	9.20
EKBP.747	3A.7	EKFA.8	16.8	EKKB.102	6.6	EKKB.130.4	6.14	EKKB.46.2	9.20
EKBP.835	3A.7	EKFA.9	16.8	EKKB.102.CB	6.3	EKKB.130.5	6.14	EKKB.46.3	9.20
EKCD.1.3	2.27	EKGH.1.3S	25.41	EKKB.102.CB	6.4	EKKB.130.6	6.14	EKKB.46.5	9.20
EKCD.1.3.CS	2.27	EKGH.10	24.6	EKKB.102.CB	6.5	EKKB.130.7	6.14	EKKB.46.6	9.20
EKCD.104.73	23.18	EKGH.110.1	17.27	EKKB.102.CB	6.6	EKKB.130.9	6.14	EKKB.46.8	9.20
EKCD.3.1.CH	6.32	EKGH.2	23.17	EKKB.103	6.7	EKKB.131.1	6.15	EKKB.49.1	17.27
EKCD.3.4	6.32	EKGH.2.1A	17.27	EKKB.103.33.CH	6.6	EKKB.131.2	6.15	EKKB.49.2	17.27
EKCD.3.CP	6.32	EKGH.2.1C	17.27	EKKB.103.72	6.7	EKKB.131.3	6.15	EKKB.49.3	17.27

EBS Reference	Page	EBS Reference	Page	EBS Reference	Page	EBS Reference	Page	EBS Reference	Page
EKKB.49.3	27.12	EKKB.80	4.5	EKKB.9.2L.CH	6.17	EKKB.95.CH	6.3	EKLU.17	20.15
EKKB.49.4	9.19	EKKB.80	18.12	EKKB.9.2L.CP	6.17	EKKB.95.CHO	6.3	EKLU.2	20.15
EKKB.49.4	9.20	EKKB.80.1	18.12	EKKB.9.2L.GB	6.17	EKKB.95.CR	6.3	EKLU.21	20.15
EKKB.49.5	17.27	EKKB.80.1A	18.12	EKKB.9.2L.PB	6.17	EKKB.95.CR	6.4	EKLU.3	20.15
EKKB.49.9	9.20	EKKB.81	4.5	EKKB.9.2M	6.18	EKKB.95.CR	6.5	EKMM.11	27.12
EKKB.49.CAP	17.27	EKKB.81	18.12	EKKB.9.2M.CH	6.18	EKKB.95.CR	6.6	EKMM.11.1	27.12
EKKB.49.SIL	17.27	EKKB.82	18.12	EKKB.9.2M.CP	6.18	EKKB.96.RP.STD	6.3	EKMM.12	6.29
EKKB.49CAP.A	17.27	EKKB.83	18.12	EKKB.9.2N	6.17	EKKB.97.1	6.2	EKMM.12.1	6.29
EKKB.49CAP.B	17.27	EKKB.83.1	18.12	EKKB.9.2N.CH	6.17	EKKB.97.CH	6.2	EKMM.12.CHO	6.29
EKKB.5	11.5	EKKB.9.2C	6.15	EKKB.9.2N.CP	6.17	EKKB.97.CP	6.2	EKMM.12.RP.STD	6.29
EKKB.5.2	11.5	EKKB.9.2C.CP	6.15	EKKB.9.2R	6.18	EKKB.99	6.4	EKMM.14	6.29
EKKB.523.3	2.24	EKKB.9.2C.CR	6.15	EKKB.9.2R.ESS	6.18	EKKB.99	6.6	EKMM.14.1	6.29
EKKB.54.1	12.12	EKKB.9.2D	6.15	EKKB.9.3G.CH	6.14	EKKB.99.CHO	6.6	EKMM.16	6.29
EKKB.54.3	12.12	EKKB.9.2D.CP	6.15	EKKB.9.3K.CH	6.18	EKKB.99.CP	6.6	EKMM.2.2	23.18
EKKB.57.1.1	17.28	EKKB.9.2E	6.15	EKKB.9.R.STD	6.2	EKKB63.4	1.16	EKMM.2.3	23.18
EKKB.57.11	17.28	EKKB.9.2E.CP	6.15	EKKB.9.R.STD	6.15	EKKBO.58.1	17.26	EKMM.3	23.18
EKKB.57.8	17.28	EKKB.9.2F	6.14	EKKB.9.RP.STD	6.2	EKKO.25	5.20	EKMM.3.1	23.18
EKKB.58.1	17.28	EKKB.9.2F.CH	6.14	EKKB.9.RP.STD	6.15	EKKO.25.1	5.20	EKMM.36	21.6
EKKB.58.2	17.28	EKKB.9.2F.CP	6.14	EKKB.91.R.STD	6.8	EKKO.25.12	5.20	EKMM.36.40	21.6
EKKB.6	27.12	EKKB.9.2F.CR	6.14	EKKB.91.R.STD	6.16	EKKO.25.13	5.20	EKMM.4.4	9.21
EKKB.6.2	27.12	EKKB.9.2F.GS	6.14	EKKB.91.RP.STD	6.8	EKKO.25.15	5.20	EKMM.4.5	9.21
EKKB.63	1.16	EKKB.9.2G	6.14	EKKB.91.RP.STD	6.16	EKKO.25.16	5.20	EKMM.4.6	9.21
EKKB.63.17	1.16	EKKB.9.2G.BU	6.7	EKKB.92	6.15	EKKO.25.18	5.20	EKMM.4.6EP	9.21
EKKB.63.18	1.16	EKKB.9.2G.BU	6.8	EKKB.92.R.STD	6.14	EKKO.25.19	5.20	EKMM.4.SIL	90.9
EKKB.63.19	1.14	EKKB.9.2G.BU	6.14	EKKB.92.RP	6.3	EKKO.25.2	5.20	EKMM.51	18.12
EKKB.63.2	1.16	EKKB.9.2G.BU	6.15	EKKB.92.RP	6.4	EKKO.25.20	5.21	EKMM.51.1	18.12
EKKB.63.2	4.4	EKKB.9.2G.BU	6.16	EKKB.92.RP	6.5	EKKO.25.21	5.21	EKMM.53	12.13
EKKB.63.20	4.4	EKKB.9.2G.BU	6.17	EKKB.92.RP	6.6	EKKO.25.22	5.21	EKMM.54	12.13
EKKB.63.21	4.4	EKKB.9.2G.BU	6.18	EKKB.92.RP	6.7	EKKO.25.22A	5.21	EKMM.54.5.A	12.13
EKKB.63.22	4.4	EKKB.9.2G.BU	6.19	EKKB.92.RP.STD	6.3	EKKO.25.24	5.21	EKMM.55	12.13
EKKB.63.23	1.14	EKKB.9.2G.BU	6.20	EKKB.92.RP.STD	6.4	EKKO.25.25	5.21	EKMM.55.1	12.13
EKKB.63.24	1.14	EKKB.9.2G.BU	6.22	EKKB.92.RP.STD	6.5	EKKO.25.26	5.21	EKMM.55.2	12.13
EKKB.63.24	4.7	EKKB.9.2G.BU	6.23	EKKB.92.RP.STD	6.6	EKKO.25.27	5.21	EKMM.55.3	12.13
EKKB.63.26	4.5	EKKB.9.2G.BU	6.24	EKKB.92.RP.STD	6.7	EKKO.25.28	5.21	EKMM.58.5	27.12
EKKB.63.27	4.5	EKKB.9.2G.BU	6.27	EKKB.92.RP.STD	6.14	EKKO.25.30	5.21	EKMM.6	11.5
EKKB.63.2U	1.16	EKKB.9.2G.CH	6.14	EKKB.92.RP.STD	6.17	EKKO.25.31	5.21	EKMM.61.1	11.5
EKKB.63.3	1.16	EKKB.9.2G.CP	6.14	EKKB.93.R.STD	6.16	EKKO.25.32	5.21	EKMM.7	9.21
EKKB.63.3	4.5	EKKB.9.2G.CR	6.14	EKKB.93.R.STD	6.17	EKKO.25.33	5.21	EKMM.7.1	9.21
EKKB.63.306	1.16	EKKB.9.2H	6.16	EKKB.93.R.STD	6.18	EKKO.25.34	5.21	EKMM.7.2	9.21
EKKB.63.4	1.16	EKKB.9.2H.CH	6.16	EKKB.93.RP.STD	6.16	EKKO.25.35	5.21	EKMM.7.4	9.21
EKKB.63.44	1.16	EKKB.9.2H.CP	6.16	EKKB.93.RP.STD	6.17	EKKO.25.36	5.21	EKMM.7.6	9.21
EKKB.63.7	1.14	EKKB.9.2H.CR	6.16	EKKB.93.RP.STD	6.18	EKKO.25.37	5.9	EKMM.7.7	9.21
EKKB.63.7	4.7	EKKB.9.2I	6.16	EKKB.94	6.2	EKKO.25.37	5.22	EKMM.7.8	9.21
EKKB.63.77	1.14	EKKB.9.2I.CH	6.16	EKKB.94.1C	6.2	EKKO.25.6	5.20	EKMM.90	6.29
EKKB.63.78	1.14	EKKB.9.2I.CP	6.16	EKKB.94.CB	6.2	EKKO.25.7	5.20	EKMM.90.CH	6.29
EKKB.63.78	4.7	EKKB.9.2IA	6.16	EKKB.94.CH	6.2	EKKO.25.8	5.20	EKMM.90.CR	6.29
EKKB.63.79	1.14	EKKB.9.2IB	6.16	EKKB.94.CR	6.2	EKKO.25.95	5.25	EKMM.90.R.STD	6.29
EKKB.63.80	1.14	EKKB.9.2IC	6.16	EKKB.94.CR	6.3	EKKO.25.95C	5.25	EKMM.90.RP.STD	6.29
EKKB.63.81	1.14	EKKB.9.2IC.CH	6.16	EKKB.94.CR	6.4	EKKO.25.96	5.25	EKMM.91.R.STD	6.29
EKKB.63.P	1.16	EKKB.9.2ID	6.17	EKKB.94.CR	6.5	EKKO.25.96C	5.25	EKMM.91.RP.STD	6.29
EKKB.63.P	4.5	EKKB.9.2IE	6.16	EKKB.94.CR	6.6	EKKO.25.97	5.25	EKMM.92.RP.STD	6.29
EKKB.68.C	1.11	EKKB.9.2IF	6.16	EKKB.95	6.3	EKKO.25.98	5.25	EKOS.10	32.2
EKKB.7.1	15.12	EKKB.9.2IP.CH	6.16	EKKB.95.1C	6.3	EKKO.25.EP	5.21	EKOS.10	32.3
EKKB.70.R.STD	6.19	EKKB.9.2K	6.19	EKKB.95.1CH	6.3	EKKP.24.1	2.27	EKOS.15	32.2
EKKB.70.RP.STD	6.19	EKKB.9.2K.CH	6.19	EKKB.95.CB	6.3	EKLU.11	20.15	EKOS.15	32.3
EKKB.8	26.14	EKKB.9.2L	6.17	EKKB.95.CB	6.4	EKLU.12	20.15	EKOS.207	32.2

EBS Reference	Page	EBS Reference	Page	EBS Reference	Page	EBS Reference	Page	EBS Reference	Page
EKOS.208	32.2	EKPP.28.8	16.10	EKS.3100.K1	3.18	EKWA.108.BF	6.20	EKWA.124	6.10
EKOS.210	32.2	EKPP.28.8.RES	16.10	EKS.3100.K2	3.18	EKWA.108.BU	6.23	EKWA.124.CH	6.10
EKOS.215	32.2	EKPP.3.12/16.LS	2.23	EKS.3100.K2	3.19	EKWA.108.CH	6.21	EKWA.125.CH	6.11
EKOS.217	32.2	EKPP.3.12B.45	2.23	EKS.3100.K3	3.18	EKWA.108.CP	6.21	EKWA.126.1	6.12
EKOS.239	32.2	EKPP.3.12B.50	2.23	EKS.3526.W1	3.44	EKWA.109	6.12	EKWA.126.CH	6.12
EKOS.25	32.3	EKPP.3.14B.57	2.23	EKS.3526.W2	3.46	EKWA.11	26.15	EKWA.13	22.10
EKOS.32	32.2	EKPP.3.14B.64	2.23	EKS.64.G	4.5	EKWA.110.20	17.9	EKWA.131	6.9
EKOS.32	32.3	EKPP.3.16B.57	2.23	EKVA.1	6.32	EKWA.110.20	23.16	EKWA.131.7	6.24
EKOS.36	32.3	EKPP.3.16B.64	2.23	EKVA.11	6.32	EKWA.110.20	30.51	EKWA.131.CH	6.9
EKOS.47	32.3	EKPP.3.16B.76	2.23	EKVA.6	6.32	EKWA.110.21	17.9	EKWA.14.1	1.17
EKOS.48	32.3	EKPP.3.20B.57	2.23	EKVO.1	6.40	EKWA.110.21	23.16	EKWA.14.3	1.17
EKOS.57	32.2	EKPP.3.20B.64	2.23	EKVO.2	6.40	EKWA.110.21	30.51	EKWA.14.6	1.17
EKOS.75	32.2	EKPP.3.20B.76	2.23	EKVO.60.C	6.40	EKWA.110.212	23.16	EKWA.140	6.21
EKOS.9	32.3	EKPP.3.24B.64	2.23	EKVO.60.RP.STD	6.40	EKWA.110.3	17.9	EKWA.15	22.10
EKPD.2	23.18	EKPP.3.24B.76	2.23	EKVO.7	6.40	EKWA.110.3	23.16	EKWA.160	6.10
EKPD.3	15.12	EKPP.3.27B.64	2.23	EKVO.7.2	6.40	EKWA.110.3	30.51	EKWA.160	6.11
EKPD.52	12.12	EKPP.3.30B.64	2.23	EKVO.7.60.C	6.40	EKWA.110.32	17.9	EKWA.160.CH	6.11
EKPD.6C	9.20	EKPP.3.30B.76	2.23	EKVO.7.92.C	6.40	EKWA.110.32	23.16	EKWA.18	9.21
EKPD.8	6.19	EKPP.3.36B.76	2.23	EKVO.7.CH	6.40	EKWA.110.32	30.51	EKWA.18.4C	9.21
EKPD.8.R.STD	6.19	EKPP.3.36B.XLS	2.23	EKVO.92.C	6.40	EKWA.110.62	17.9	EKWA.18.4C	16.10
EKPD.8.RP.STD	6.19	EKPP.3.9B.45	2.23	EKVO.92.RP.STD	6.40	EKWA.110.82	17.9	EKWA.18.5	9.21
EKPP.21	8.10	EKPP.3.9B.50	2.23	EKWA.1.1	10.10	EKWA.110.82	23.16	EKWA.19.1	9.21
EKPP.22	8.10	EKPP.32	8.10	EKWA.1.1	24.6	EKWA.110.82	30.51	EKWA.19.10C	9.22
EKPP.23	10.10	EKPP.32.1	8.10	EKWA.1.2	26.15	EKWA.110.92	17.9	EKWA.19.11	9.22
EKPP.23.C	10.10	EKPP.32.2	8.10	EKWA.10	2.28	EKWA.110.92	23.16	EKWA.19.11A	9.22
EKPP.25	5.24	EKPP.33	10.10	EKWA.10.1	2.28	EKWA.110.92	30.51	EKWA.19.12	9.22
EKPP.26.1	10.11	EKPP.4.1	25.40	EKWA.10.1	24.6	EKWA.111	6.23	EKWA.19.13	9.22
EKPP.26.10	8.9	EKPP.4.10	25.40	EKWA.100	6.12	EKWA.113	6.22	EKWA.19.14	9.22
EKPP.26.11	8.9	EKPP.4.11	25.40	EKWA.100.1	6.12	EKWA.113	6.21	EKWA.19.15	9.22
EKPP.26.12	8.9	EKPP.4.12	25.40	EKWA.10000	13.9	EKWA.113.CH	6.22	EKWA.19.16	9.22
EKPP.26.13	8.9	EKPP.4.13	25.40	EKWA.10000	17.8	EKWA.114	6.9	EKWA.19.17	9.22
EKPP.26.14	10.11	EKPP.4.14	25.40	EKWA.10001	1.17	EKWA.114	6.10	EKWA.19.2	9.21
EKPP.26.17	10.11	EKPP.4.2	25.40	EKWA.10002	5.23	EKWA.114.CH	6.9	EKWA.19.3	9.21
EKPP.26.2	10.11	EKPP.4.3	25.40	EKWA.10003	17.8	EKWA.115	6.9	EKWA.19.48	9.22
EKPP.26.3	10.11	EKPP.4.4	25.40	EKWA.10004	17.29	EKWA.115.CH	6.9	EKWA.19.49	9.22
EKPP.26.4	10.11	EKPP.4.5	25.40	EKWA.10005	17.29	EKWA.116	6.10	EKWA.19.50	9.22
EKPP.26.5A	8.10	EKPP.4.6	25.40	EKWA.10006	6.28	EKWA.116.CH	6.10	EKWA.19.6	9.21
EKPP.26.5C	8.10	EKPP.4.7	25.40	EKWA.10007	6.28	EKWA.117	6.9	EKWA.19.8	9.22
EKPP.26.6A	8.10	EKPP.4.8	25.40	EKWA.10009	10.10	EKWA.118	6.36	EKWA.19.TC	9.22
EKPP.26.7	8.10	EKPP.4.9	25.40	EKWA.10010	10.10	EKWA.118	6.37	EKWA.2	10.10
EKPP.26.8	8.9	EKPP.42.1	10.10	EKWA.101	6.12	EKWA.118.CB	6.37	EKWA.2	24.6
EKPP.26.9	8.9	EKPP.9	6.32	EKWA.102	6.36	EKWA.118.CB	6.35	EKWA.2.2	10.10
EKPP.27	8.9	EKPP.9.1	6.32	EKWA.102.CH	6.36	EKWA.118.CH	6.37	EKWA.2.2	24.6
EKPP.28	16.10	EKPP.9.1.C	6.32	EKWA.103	6.10	EKWA.118.CR	6.37	EKWA.2.3	24.6
EKPP.28.1	16.10	EKPP.9.1.CB	6.32	EKWA.103.RV	6.10	EKWA.118.RP.STD	6.36	EKWA.20	9.22
EKPP.28.1/2	16.10	EKPP.9.1.CH	6.32	EKWA.104	6.11	EKWA.118.RP.STD	6.37	EKWA.21	9.22
EKPP.28.10	16.10	EKPP.9.C	6.32	EKWA.104.CH	6.11	EKWA.118.RP.STD	6.38	EKWA.22.3	26.15
EKPP.28.11	16.10	EKPP.9.CB	6.32	EKWA.105	6.11	EKWA.119.CH	6.9	EKWA.22.31	26.15
EKPP.28.12	16.10	EKPP.9.CH	6.32	EKWA.106	14.18	EKWA.120	6.11	EKWA.22.4	26.15
EKPP.28.14	16.10	EKPP.9.CR	6.32	EKWA.107	6.22	EKWA.121	6.12	EKWA.22.A	26.15
EKPP.28.2	16.10	EKPP.9.CS	6.32	EKWA.108	6.21	EKWA.121.CH	6.12	EKWA.23.1	10.10
EKPP.28.3	5.25	EKPP.9.RP	6.32	EKWA.108.1	6.20	EKWA.122	6.11	EKWA.23.2	10.10
EKPP.28.4	16.10	EKS.0041	14.17	EKWA.108.1CH	6.20	EKWA.123	6.26	EKWA.23.3	10.10
EKPP.28.5	16.10	EKS.0042	14.17	EKWA.108.2	6.20	EKWA.123.11	6.22	EKWA.23.4A	26.15
EKPP.28.6	16.10	EKS.1000	2.27	EKWA.108.3	6.20	EKWA.123.14	6.23	EKWA.23.5	10.10
EKPP.28.7	16.10	EKS.1001	2.27	EKWA.108.BF	6.21	EKWA.123.CH	6.26	EKWA.24.1	10.10

EBS Reference	Page	EBS Reference	Page	EBS Reference	Page	EBS Reference	Page	EBS Reference	Page
EKWA.25.4	10.10	EKWA.31.S3	13.9	EKWA.55	12.14	EKWA.63.31	1.17	EKWA.81	4.6
EKWA.26	14.18	EKWA.31.S5	13.9	EKWA.55.1	12.14	EKWA.63.32	1.17	EKWA.81	18.13
EKWA.26.1	14.18	EKWA.32.1	17.28	EKWA.55.10	12.14	EKWA.63.37	1.15	EKWA.81.PM	18.13
EKWA.26.3	14.18	EKWA.32.102	17.28	EKWA.55.9	12.14	EKWA.63.4	1.17	EKWA.9.10	6.25
EKWA.26.4	14.18	EKWA.32.104	17.28	EKWA.56.3	23.18	EKWA.63.40	1.17	EKWA.9.10.CH	6.25
EKWA.26.6	14.18	EKWA.32.104.C	17.28	EKWA.56.3C	23.18	EKWA.63.40	4.5	EKWA.9.11	6.25
EKWA.26.7	14.18	EKWA.32.105	17.28	EKWA.56.4	23.18	EKWA.63.41	1.17	EKWA.9.11.CH	6.25
EKWA.26.8	14.18	EKWA.32.1A	17.28	EKWA.56.6	26.15	EKWA.63.42	1.15	EKWA.9.12.CH	6.28
EKWA.27	5.22	EKWA.32.S1	17.26	EKWA.56.C	23.18	EKWA.63.45	1.17	EKWA.9.2.CH	6.21
EKWA.27.1	5.22	EKWA.33.1	23.18	EKWA.57	23.18	EKWA.63.45C	1.17	EKWA.9.3.CH	6.26
EKWA.27.4	5.22	EKWA.33.2	23.18	EKWA.57.12	23.19	EKWA.63.5	1.17	EKWA.9.3.CHO	6.26
EKWA.28	5.22	EKWA.34	10.10	EKWA.57.14	23.19	EKWA.63.52	1.17	EKWA.9.4	6.27
EKWA.28.10	5.23	EKWA.35.2	21.7	EKWA.57.15	23.19	EKWA.63.52	4.5	EKWA.9.4.CHP	6.27
EKWA.28.12	5.23	EKWA.36	21.7	EKWA.57.3	23.19	EKWA.63.7	1.15	EKWA.9.5	6.26
EKWA.28.16	5.23	EKWA.36	23.18	EKWA.57.5	23.19	EKWA.63.7	4.7	EKWA.9.5.CH	6.26
EKWA.28.16A	5.23	EKWA.36	26.15	EKWA.57.5D	17.28	EKWA.63.8A	1.15	EKWA.9.6	6.37
EKWA.28.17	5.23	EKWA.36.1	21.7	EKWA.57.6	17.28	EKWA.63.9C	1.17	EKWA.9.6.CH1	6.37
EKWA.28.19	5.23	EKWA.36.2	21.7	EKWA.57.6B	17.28	EKWA.64	14.16	EKWA.9.6.CH2	6.37
EKWA.28.20	5.23	EKWA.36.4	21.7	EKWA.57.6E	17.29	EKWA.64	15.11	EKWA.9.7	6.21
EKWA.28.22	5.23	EKWA.37	11.6	EKWA.57.7	23.19	EKWA.64.1	14.16	EKWA.9.7CH	6.21
EKWA.28.23	5.23	EKWA.37.1	11.6	EKWA.57.8	17.29	EKWA.64.1	15.11	EKWA.9.8	6.27
EKWA.28.24	5.23	EKWA.42	15.12	EKWA.58.1	27.13	EKWA.64.2	14.16	EKWA.9.8.CH	6.27
EKWA.28.25	5.23	EKWA.42	15.13	EKWA.58.10	27.13	EKWA.64.2	15.11	EKWA.9.9.CH	6.28
EKWA.28.26	5.23	EKWA.42.D	15.12	EKWA.58.12	17.29	EKWA.64.40	4.5	EKWA.9.9.CP	6.28
EKWA.28.3	5.22	EKWA.43	15.13	EKWA.58.4	27.13	EKWA.64.41	4.5	EKWA.9.C	6.23
EKWA.28.30	5.23	EKWA.43.D	15.13	EKWA.58.5	27.13	EKWA.64.41	4.6	EKWA.9.D	6.23
EKWA.28.31	5.23	EKWA.44	15.13	EKWA.58.5C	27.13	EKWA.64.42	4.5	EKWA.9.E	6.24
EKWA.28.32	5.23	EKWA.44.D	15.13	EKWA.58.7	23.19	EKWA.64.43	4.6	EKWA.9.E.CH	6.24
EKWA.28.3A	5.22	EKWA.45	15.12	EKWA.58.8	27.13	EKWA.64.52	4.6	EKWA.9.F	6.24
EKWA.28.4	5.22	EKWA.47.1	2.28	EKWA.58.9	23.19	EKWA.64.GS	4.5	EKWA.9.F.CH	6.24
EKWA.28.8	5.22	EKWA.47.10	2.28	EKWA.58.S1	27.13	EKWA.65.1	4.6	EKWA.9.G	6.24
EKWA.28.9	5.22	EKWA.47.1G	2.28	EKWA.59	21.7	EKWA.65.A	4.6	EKWA.9.H	6.26
EKWA.28.9B	5.22	EKWA.47.5	2.28	EKWA.59.1	21.7	EKWA.65.B	4.6	EKWA.9.H.CH	6.26
EKWA.28.A	5.22	EKWA.48	2.28	EKWA.59.2	22.10	EKWA.68	15.13	EKWA.9.I	6.22
EKWA.28.B1	5.22	EKWA.48.1	2.28	EKWA.59.4	21.7	EKWA.68.D	15.13	EKWA.9.I.CH	6.22
EKWA.28.B2	5.22	EKWA.48.1G	2.28	EKWA.59.4C	21.7	EKWA.69	15.13	EKWA.9.K	6.25
EKWA.28.D	5.22	EKWA.48.8	2.28	EKWA.60.1	7.5	EKWA.69.D	15.13	EKWA.9.L	6.25
EKWA.30	23.18	EKWA.49	2.28	EKWA.60.3	8.10	EKWA.70	15.14	EKWA.9.L.CH	6.25
EKWA.30	27.13	EKWA.5	16.10	EKWA.61	11.6	EKWA.71	15.13	EKWA.90.C	6.24
EKWA.30.1	23.18	EKWA.51	18.13	EKWA.61.1A	11.6	EKWA.71.A	15.12	EKWA.90.CP	6.24
EKWA.30.3	27.13	EKWA.51.14	18.13	EKWA.61.3A	11.6	EKWA.71.A	15.13	EKWA.90.CR	6.25
EKWA.31	8.10	EKWA.51.15	18.13	EKWA.63	1.12	EKWA.71.D	15.13	EKWA.90.CR	6.24
EKWA.31.1	8.10	EKWA.51.4	18.13	EKWA.63.1	1.17	EKWA.72	2.28	EKWA.90.RP.STD	6.26
EKWA.31.10A	8.10	EKWA.51.5	18.13	EKWA.63.11	1.17	EKWA.73	15.14	EKWA.90.RP.STD	6.23
EKWA.31.12	8.10	EKWA.51.6	18.13	EKWA.63.12	1.12	EKWA.74	15.12	EKWA.90.RP.STD	6.24
EKWA.31.14	8.10	EKWA.51.7	18.13	EKWA.63.12	1.17	EKWA.74	15.13	EKWA.90.RP.STD	6.25
EKWA.31.2	8.10	EKWA.52	12.13	EKWA.63.14	1.15	EKWA.75	15.13	EKWA.92.A	6.10
EKWA.31.3	13.9	EKWA.52.C	12.13	EKWA.63.18	1.17	EKWA.76	15.13	EKWA.93	6.10
EKWA.31.6	13.9	EKWA.53	12.13	EKWA.63.18C	1.17	EKWA.80	4.6	EKWA.93.1	6.36
EKWA.31.7	8.10	EKWA.54.1	12.6	EKWA.63.19	1.15	EKWA.80	18.13	EKWA.93.1	6.32
EKWA.31.9	13.9	EKWA.54.1	12.13	EKWA.63.20	1.17	EKWA.80.1	4.6	EKWA.93.1	6.33
EKWA.31.S1	13.9	EKWA.54.1B	12.13	EKWA.63.20	4.5	EKWA.80.1	18.13	EKWA.93.1	6.35
EKWA.31.S1A	13.9	EKWA.54.2	12.13	EKWA.63.23	1.15	EKWA.80.1A	4.6	EKWA.93.3	6.10
EKWA.31.S1B	13.9	EKWA.54.3	12.13	EKWA.63.24	1.17	EKWA.80.1A	18.13	EKWA.95.C	6.23
EKWA.31.S1C	13.9	EKWA.54.A	12.14	EKWA.63.30	1.15	EKWA.80.2	4.6	EKWA.95.CR	6.9
EKWA.31.S2	13.9	EKWA.54.ICV	12.13	EKWA.63.30	4.7	EKWA.80.2	18.13	EKWA.95.CR	6.10

EBS Reference	Page	EBS Reference	Page	EBS Reference	Page	EBS Reference	Page	EBS Reference	Page
EKWA.95.CR	6.20	EKWA.99.R.STD	6.12	EKWL.112	3A.10	FLANGESEAL-5	6.42	N8901103500	2.7
EKWA.95.CR	6.21	EKWA.99.RP.STD	6.10	EKWL.113	3A.10	FLANGESEAL-6	6.42	N8901103510	2.7
EKWA.95.CR	6.23	EKWA.99.RP.STD	6.12	EKWL.115	3A.10	FLANGESEAL-7	6.42	N8901103520	2.7
EKWA.95.CR	6.24	EKWL.001	3A.8	EKWL.117	3A.10	FLANGESEAL-8	6.42	N8901103530	2.7
EKWA.95.CR	6.26	EKWL.002	3A.8	EKWL.119	3A.10	FLANGESEAL-9	6.42	N8901103540	2.7
EKWA.95.R.STD	6.9	EKWL.003	3A.8	EKWL.120	3A.10	GAITER-1	2.24	N8901103570	2.7
EKWA.95.R.STD	6.10	EKWL.004	3A.8	EKWL.121	3A.10	GAITER-2	2.24	N8901103600	2.7
EKWA.95.R.STD	6.11	EKWL.005	3A.8	EKWL.122	3A.10	GAITER-3	2.24	N8901103690	2.7
EKWA.95.R.STD	6.20	EKWL.006	3A.8	EKWL.123	3A.10	HINO30S	2.22	N8901103700	2.7
EKWA.95.R.STD	6.21	EKWL.007	3A.8	EKWL.124	3A.10	JY.9031.3	3.23	N9254911410	2.11
EKWA.95.R.STD	6.22	EKWL.008	3A.8	EKWL.125	3A.10	JYEC.0001	3.21	NAB1430202	2.20
EKWA.95.R.STD	6.23	EKWL.010	3A.8	EKWL.126	3A.10	JYEC.0001/1	3.21	NC717	2.24
EKWA.95.R.STD	6.24	EKWL.011	3A.8	EKWL.127	3A.10	JYEC.0001/FB	3.21	NC718	2.24
EKWA.95.R.STD	6.26	EKWL.012	3A.8	EKWL.128	3A.10	JYEC.0002	3.21	NC719	2.24
EKWA.95.R.STD	6.27	EKWL.013	3A.8	EKWL.131	3A.10	JYEC.0002/1	3.21	NC720	2.24
EKWA.95.R.STD	6.28	EKWL.014	3A.8	EKWL.132	3A.10	JYEC.0002/FB	3.21	NK012501	2.3
EKWA.95.RP.STD	6.9	EKWL.015	3A.8	EKWL.133	3A.10	N109552	6.31	NK012502	2.3
EKWA.95.RP.STD	6.10	EKWL.015	3A.11	EKWL.134	3A.10	N133.527FA	11.4	NKW1491/1	6.13
EKWA.95.RP.STD	6.11	EKWL.016	3A.8	EKWL.137	3A.10	N16412894	2.22	NSK2950/6	2.24
EKWA.95.RP.STD	6.12	EKWL.017	3A.9	EKWL.140	3A.10	N16421768	5.14	NSK2950/7	2.24
EKWA.95.RP.STD	6.19	EKWL.018	3A.9	EKWL.141	3A.11	N264432	25.38	NSK2950/8	2.24
EKWA.95.RP.STD	6.20	EKWL.019	3A.9	EKWL.142	3A.11	N264433	25.38	NSK2950/9	2.24
EKWA.95.RP.STD	6.21	EKWL.020	3A.9	EKWL.143	3A.11	N267026	25.38	NT10DP	2.24
EKWA.95.RP.STD	6.22	EKWL.021	3A.9	EKWL.144	3A.11	N267027	25.38	NT12DP	2.24
EKWA.95.RP.STD	6.23	EKWL.022	3A.9	EKWL.145	3A.11	N267083	25.38	NT14DP	2.24
EKWA.95.RP.STD	6.24	EKWL.023	3A.9	EKWL.146	3A.11	N267084	25.38	NT16DP	2.24
EKWA.95.RP.STD	6.26	EKWL.024	3A.9	EKWL.150	3A.11	N274971	25.38	NT18DP	2.24
EKWA.95.RP.STD	6.28	EKWL.025	3A.9	EKWL.151	3A.11	N281966	25.39	NT20DP	2.24
EKWA.95.RP.STD	6.37	EKWL.026	3A.9	EKWL.152	3A.11	N281967	25.39	NT24DP	2.24
EKWA.96.A	6.39	EKWL.027	3A.9	EKWL.154	3A.11	N295184	25.39	NT30DP	2.24
EKWA.96.CH	6.39	EKWL.028	3A.9	EKWL.156	3A.11	N295567	25.39	QRV1	22.7
EKWA.96.CR	6.9	EKWL.029	3A.9	EKWL.157	3A.11	N356743	2.18	QRV10	22.7
EKWA.96.CR	6.10	EKWL.031	3A.9	EKWL.158	3A.11	N4253620020	2.22	QRV11	22.7
EKWA.96.CR	6.11	EKWL.032	3A.9	EKWL.159	3A.11	N4608067	5.14	QRV12	22.7
EKWA.96.CR	6.21	EKWL.033	3A.9	EKWL.160	3A.11	N6009	26.8	QRV13	22.8
EKWA.96.CR	6.22	EKWL.034	3A.9	EKWL.265	3A.11	N6010	26.8	QRV14	22.8
EKWA.96.CR	6.26	EKWL.035	3A.9	EKWL.300	25.41	N6011M	26.8	QRV14	22.9
EKWA.96.CR	6.27	EKWL.037	3A.9	EKWL.301	25.41	N6012M	26.8	QRV15	22.10
EKWA.97.A	6.34	EKWL.038	3A.9	EKZF.1	20.13	N6013M	26.8	QRV16	22.8
EKWA.97.CR	6.36	EKWL.039	3A.9	EKZF.1	20.15	N6014K	26.15	QRV17	22.8
EKWA.97.CR	6.32	EKWL.040	3A.9	EKZF.2	20.13	N6015K	26.15	QRV18	22.8
EKWA.97.CR	6.33	EKWL.041	3A.9	EKZF.7	20.7	N6016	26.2	QRV2	22.7
EKWA.97.CR	6.35	EKWL.043	3A.9	EKZF.9	20.7	N6017	26.2	QRV3	22.7
EKWA.97.CS	6.33	EKWL.044	3A.9	FLANGEGASKET-1	6.41	N6017	26.6	QRV4	22.7
EKWA.97.CS	6.34	EKWL.045	3A.9	FLANGEGASKET-2	6.41	N6018S	26.15	QRV5	22.7
EKWA.97.CS	6.35	EKWL.046	3A.9	FLANGESEAL-1	6.41	N6019K	26.15	QRV6	22.7
EKWA.97.CS	6.36	EKWL.047	3A.9	FLANGESEAL-10	6.42	N6020K	26.15	QRV7	22.9
EKWA.97.CS	6.37	EKWL.048	3A.9	FLANGESEAL-11	6.42	N64201608	5.15	QRV8	22.7
EKWA.97.RP.STD	6.33	EKWL.101	3A.9	FLANGESEAL-12	6.42	N64203502	5.15	QRV9	22.7
EKWA.97.RP.STD	6.34	EKWL.102	3A.10	FLANGESEAL-13	6.42	N64203505	5.15	R01.03.1004	1.3
EKWA.97.RP.STD	6.35	EKWL.104	3A.10	FLANGESEAL-14	6.42	N723539ICV	12.5	R01.03.1007	1.2
EKWA.97.RP.STD	6.36	EKWL.107	3A.10	FLANGESEAL-15	6.42	N78165	1.16	R01.03.4001	1.2
EKWA.97.W	6.35	EKWL.108	3A.10	FLANGESEAL-16	6.42	N8901103280	2.7	R01.04.1700	1.2
EKWA.97.W	6.33	EKWL.109	3A.10	FLANGESEAL-2	6.41	N8901103470	2.7	R01.04.2407	1.2
EKWA.99	6.12	EKWL.110	3A.10	FLANGESEAL-3	6.41	N8901103480	2.7	R01.04.2408	1.2
EKWA.99.1	6.12	EKWL.111	3A.10	FLANGESEAL-4	6.41	N8901103490	2.7	R01.06.1000	1.3

EBS Reference	Page	EBS Reference	Page	EBS Reference	Page	EBS Reference	Page	EBS Reference	Page
R01.06.1001	1.3	R06.02.2851	6.45	R0936272110	3.7	R17.03.1011	17.5	R40225016	3.6
R02.01.3030.928	2.11	R06.02.2861	6.45	R0936272120	3.7	R17.04.1023	17.9	R40225016	3.8
R02.03.14.504	2.17	R06.02.2863	6.45	R0936272131	3.7	R17.04.1023	17.10	R40225025	3.8
R02.04.09.9072	2.17	R06.02.2864	6.45	R0936272141	3.7	R17.04.1025	17.9	R40225026	3.8
R02.04.0916.113	2.17	R06.02.2871	6.45	R12.06.1005	12.12	R17.04.1025	17.10	R40456033	3.8
R02.04.2416.101	2.17	R06.02.2934	6.45	R15.02.5408	15.4	R17.04.1030	17.9	R40456034	3.8
R02.12.0521	2.21	R06.02.2957	6.45	R15.02.5504	15.4	R17.04.1030	17.10	R40465019	3.8
R02.14.K001	2.19	R06.02.2961	6.45	R15.03.1001	15.3	R17.04.1033	17.9	R40465020	3.8
R02.14.K002	2.19	R06.02.2964	6.45	R15.03.1002	15.3	R17.04.1033	17.10	R42532300	3.8
R02.14.K003	2.19	R06.02.2967	6.45	R15.07.1000	15.5	R17.04.2017	17.10	R42532301	3.8
R02.14.K005	2.19	R06.02.2970	6.45	R15.08.1001	15.3	R17.04.2019	17.10	R42532302	3.8
R02.14.K006	2.19	R06.02.2974	6.46	R15.08.1002	15.3	R17.04.2021	17.10	R42532303	3.8
R02.14.K007	2.19	R06.02.2983	6.46	R16.01.2004	16.7	R17.04.2025	17.10	R42532304	3.8
R02.14.K008	2.19	R06.02.2985	6.46	R16.01.2006	16.7	R17.04.3014	17.10	R42532305	3.8
R02.14.K009	2.19	R06.02.2997	6.46	R17.01.3014	17.15	R17.04.3022	17.10	R42533002	3.8
R02.14.K010	2.19	R06.06.1003	6.46	R17.01.3031	17.15	R18.02.1528	18.4	R42533004	3.8
R02.14.K011	2.19	R06.06.1004	6.46	R17.01.3033	17.15	R18.02.6000	18.6	R42559201	3.8
R02.15.2527	2.22	R06.06.1005	6.46	R17.01.3034	17.15	R21.01.A012	21.5	R42559202	3.8
R04.02.0741	4.3	R06.06.1006	6.47	R17.01.3064	17.16	R23.01.2802	23.12	R4750180120	21.5
R04.02.0742	4.3	R06.06.1007	6.46	R17.01.4011	17.14	R23.06.1007	23.3	R92503	3.7
R04.02.0891	4.3	R06.06.1008	6.46	R17.01.4012	17.14	R23.06.2001	23.2	R93839	3.7
R04.02.5906	4.3	R06.06.1009	6.46	R17.01.4015	17.14	R23.06.2002	23.2	R93840	3.7
R04.02.8209	4.3	R06.06.1010	6.46	R17.01.4018	17.14	R27.01.4005	27.10	R94605	3.7
R05.02.2874	5.16	R06.06.1011	6.46	R17.01.4022	17.14	R27.01.4007	27.10	R95620	3.7
R05.02.2875	5.16	R06.06.1012	6.47	R17.01.4024	17.14	R27.06.1007	27.4	R95621	3.7
R06.01.1000	6.48	R06.06.1013	6.47	R17.01.4041	17.14	R3080008100	3.7	RDX19551K	3.7
R06.01.1001	6.48	R09.01.3264	9.16	R17.01.4042	17.14	R3080008200	3.7	RDX19552K	3.7
R06.01.1004	6.48	R09.01.4018	9.16	R17.01.4043	17.14	R34.29.9001	34.8	RK000026	3.9
R06.01.1009	6.48	R09.01.8010	9.18	R17.01.4061	17.14	R34.29.9002	34.8	RK000027	3.9
R06.01.2008	6.48	R09.01.E025	9.15	R17.01.4063	17.14	R34.30.9001	34.8	RK001105	3.9
R06.01.2018	6.48	R09.01.E605	9.15	R17.01.5001	17.14	R40100001	3.8	RK001275	3.9
R06.01.3506	6.48	R09.02.0156	9.7	R17.01.5002	17.14	R40100002	3.8	RK001494	3.9
R06.01.4003	6.49	R09.02.0158	9.7	R17.01.5003	17.14	R40160015	3.8	RK001505	3.9
R06.01.4005	6.49	R09.02.0159	9.7	R17.01.5005	17.14	R40160016	3.8	RK001507	3.9
R06.01.4015	6.49	R09.02.4469	9.7	R17.01.5006	17.14	R40175049	3.8	RK001510	3.9
R06.02.1567	6.43	R09.02.4512	9.7	R17.01.5009	17.14	R40175050	3.8	RK001531	3.9
R06.02.1813	6.43	R09.02.4694	9.7	R17.01.5106	17.14	R40175062	3.8	RK001916	3.9
R06.02.1814	6.43	R09.02.4696	9.7	R17.01.5107	17.14	R40175063	3.8	RK001927	3.9
R06.02.1833	6.43	R09.02.4928	9.7	R17.01.6006	17.15	R40175064	3.8	RK002709	3.7
R06.02.1840	6.43	R09.02.9000	9.9	R17.01.6007	17.15	R40175065	3.8	RK002797	3.7
R06.02.1841	6.43	R09.02.9530	9.7	R17.02.0022	17.11	R40175072	3.8	RK002798	3.7
R06.02.1850	6.43	R09.02.9544	9.7	R17.02.0023	17.11	R40175073	3.8	RK002919	3.7
R06.02.1859	6.43	R09.02.9546	9.8	R17.02.0024	17.11	R40195011	3.8	RK002920	3.7
R06.02.1869	6.43	R09.02.9569	9.8	R17.02.0623	17.11	R40195012	3.8	RK002923	3.7
R06.02.1875	6.43	R09.02.9571	9.8	R17.02.0624	17.11	R40195021	3.8	RK002924	3.7
R06.02.1918	6.43	R09.04.2001	9.5	R17.02.0624	27.4	R40195022	3.8	RK002964	3.7
R06.02.1920	6.43	R09.04.2003	9.5	R17.02.1202	17.10	R40195037	3.8	RK002965	3.7
R06.02.1921	6.43	R09.06.1010	9.2	R17.02.1203	17.10	R40195038	3.8	RK003192	3.7
R06.02.1936	6.44	R09.06.1011	9.3	R17.02.1204	17.10	R40195039	3.8	RK003193	3.7
R06.02.1941	6.44	R09.06.1012	9.3	R17.02.1213	17.11	R40195040	3.8	RK003779	3.7
R06.02.1944	6.44	R09.06.1013	9.2	R17.02.1411	17.11	R40195045	3.8	RK003780	3.7
R06.02.1947	6.44	R09.06.1014	9.3	R17.02.2000	17.11	R40195046	3.8	RK003781	3.7
R06.02.2701	6.44	R09.07.1011	9.11	R17.02.2014	17.11	R40225003	3.8	RK003782	3.7
R06.02.2812	6.44	R09.07.1013	9.11	R17.02.2053	17.11	R40225004	3.8	RK003783	3.7
R06.02.2823	6.44	R09.09.1005	9.6	R17.02.5415	17.10	R40225015	3.6	RK003784	3.7
R06.02.2845	6.45	R09.09.1006	9.6	R17.02.5417	17.10	R40225015	3.8	RK003789	3.7

EBS Reference	Page	EBS Reference	Page	EBS Reference	Page	EBS Reference	Page
RK003790	3.7	RK052381	3.7	RLRG601	3.8	SEAL-2	17.26
RK003791	3.7	RLRG500	3.7	RLRG602	3.8	SECKM.7.3	3.36
RK003792	3.7	RLRG501	3.7	RLRG603	3.8	SECKM.7.5	3.39
RK003793	3.7	RLRG506	3.7	RLRG606	3.8	SEKBO.1.4	27.12
RK003794	3.7	RLRG507	3.7	RLRG607	3.8	SEKBO.3	14.17
RK003798	3.7	RLRG508	3.7	RLRG608	3.8	SEKKB.6	27.12
RK003799	3.7	RLRG509	3.7	RLRG609	3.8	SEKKB.9.2F	6.14
RK003800	3.7	RLRG510	3.7	RLRG610	3.8	SEKMM.55.1	12.13
RK003803	3.7	RLRG511	3.7	RLRG611	3.8	SEKWA.107	6.22
RK003804	3.7	RLRG520	3.7	RLRG612	3.8	SEKWA.26.6	14.18
RK003805	3.7	RLRG521	3.7	RLRG613	3.8	SEKWA.28.9	5.22
RK003806	3.7	RLRG522	3.7	RLRG620	3.8	SEKWA.33.1	23.18
RK003807	3.7	RLRG523	3.7	RLRG621	3.8	SEKWA.55	12.14
RK003808	3.7	RLRG524	3.7	RLRG622	3.8	SEKWA.55.1	12.14
RK003809	3.7	RLRG525	3.7	RLRG623	3.8	SEKWA.56	23.18
RK003810	3.7	RLRG526	3.7	RLRG624	3.8	SEKWA.58.1	27.13
RK003811	3.7	RLRG527	3.7	RLRG625	3.8	SEKWA.61	11.6
RK003812	3.7	RLRG530	3.7	RLRG626	3.8	SEKWA.61.1	11.6
RK003813	3.7	RLRG531	3.7	RLRG627	3.8	SEKWA.63.9C	1.17
RK003814	3.7	RLRG536	3.7	RLRG630	3.8	SEKWA.9.4	6.27
RK003815	3.7	RLRG537	3.7	RLRG631	3.8	SEKWA.9.5	6.26
RK003816	3.7	RLRG542	3.7	RLRG634	3.8	SP18	2.24
RK003825	3.7	RLRG543	3.7	RLRG635	3.8	SP20	2.24
RK003826	3.7	RLRG544	3.7	RLRG638	3.8	SPRINGARM	15.11
RK004570	3.7	RLRG545	3.7	RLRG639	3.8	T02	6.42
RK004571	3.7	RLRG546	3.7	RLRG648	3.8	T16RD	2.23
RK004572	3.7	RLRG547	3.7	RLRG649	3.8	T20RD	2.23
RK004573	3.7	RLRG548	3.7	RLRG650	3.8	T24RD	2.23
RK004580	3.7	RLRG549	3.7	RLRG651	3.8	YOKE1	2.24
RK004581	3.7	RLRG550	3.7	RLRG670	3.8	YOKE3	2.24
RK005481	3.7	RLRG551	3.7	RLRG690	3.8	YOKE4	2.24
RK005482	3.7	RLRG553	3.7	RLRG700	3.8	YOKE5	2.24
RK005610	3.7	RLRG554	3.7	RLRG701	3.8	YOKE6	2.24
RK005611	3.7	RLRG560	3.7	RLRG702	3.8	YOKE7	2.24
RK009161	3.7	RLRG561	3.7	RLRG703	3.8	YOKE8	2.24
RK009162	3.7	RLRG568	3.7	RLRG726	3.8	YOKE9	2.24
RK010765	3.9	RLRG569	3.7	RLRG727	3.8	ZJ117	25.41
RK011479	3.9	RLRG570	3.7	RLRG728	3.8	ZJ118	25.34
RK012619	3.9	RLRG571	3.7	RLRG729	3.8	ZJ118	25.41
RK012633	3.7	RLRG572	3.7	RLRG730	3.8		
RK012634	3.7	RLRG573	3.7	RLRG731	3.8		
RK013160	3.7	RLRG574	3.7	RLRG736	3.8		
RK013161	3.7	RLRG575	3.7	RLRG737	3.8		
RK013175	3.7	RLRG580	3.7	RLRG740	3.8		
RK013176	3.7	RLRG581	3.7	RLRG741	3.8		
RK013203	3.7	RLRG586	3.7	RLRG764	3.8		
RK013204	3.7	RLRG587	3.7	RLRG765	3.8		
RK013672	3.9	RLRG588	3.7	RMCK1331	3.9		
RK015308	3.9	RLRG589	3.7	RMCK1332	3.9		
RK016515	3.7	RLRG592	3.7	RMCK1345	3.9		
RK040946	3.7	RLRG593	3.7	RMCK1346	3.9		
RK040953	3.7	RLRG596	3.7	RMCK1376	3.9		
RK040954	3.7	RLRG597	3.7	RMCK1377	3.9		
RK046528	3.4	RLRG598	3.8	RMCK1385	3.9		
RK046529	3.4	RLRG599	3.8	RMCK1386	3.9		
RK052380	3.7	RLRG600	3.8	SEAL-1	17.28		

CROSS REFERENCES

CROSS REFERENCES

Manufacturers Part Numbers are for the purpose of reference only.

CROSS
REF.

Cross Reference	Page	Cross Reference	Page	Cross Reference	Page	Cross Reference	Page	Cross Reference	Page
0001539520	30.22	0014603080	20.2	0024605580	20.10	0265008414	30.48	0481007031000	7.2
0002603298	10.8	0014603080	20.7	0024606580	20.7	0265008429	30.48	0481007049	7.2
0002603398	10.9	0014603080	20.9	0024607580	20.7	0265050109	30.2	0481007501	7.2
00026035630080	24.5	0014603180	20.9	0024608880	20.7	0265050110	30.2	0481009014000	21.2
0002604663	24.5	00146031800	20.7	0024608980	20.7	0265050112	30.3	0481009015000	21.2
0004601480	20.7	0014604480	20.9	0024665701	20.7	0265050128	30.2	0481009017000	21.2
0004601580	20.7	0014605180	20.7	0024667501	20.9	0265050143	30.2	0481009018000	21.2
0004602480	20.7	0014605280	20.7	0024667601	20.9	0265050150	30.3	0481009019000	21.2
0004602680	20.7	0014605980	20.7	0025420518	30.20	0265351102	17.4	0481009020000	21.2
0004606180	20.8	0014606080	20.7	0025422518	30.20	0265351108	17.4	0481009021000	21.2
0004606680	20.7	0014606880	20.8	0025425818	30.54	0265351118	17.4	0481009022000	21.2
0004606880	20.7	001460688080	20.8	0025426818	30.20	0268008430	30.48	0481009023000	21.2
0004611480	20.7	0014607080	20.7	0029971847	32.2	027022209	26.14	0481009026000	21.2
0004612480	20.7	0014607280	20.8	0031539828	30.65	027049009	13.7	0481009027000	21.3
0004660718	30.68	0014608080	20.9	0034600380	20.9	027049009	13.9	0481009029000	21.3
0004666701	20.7	0014608480	20.8	0034601980	20.2	027059409	26.14	0481009030000	21.3
0004667001	20.8	0014608580	20.8	0034601980	20.7	028044309	26.14	0481009034000	21.3
0005403417	30.21	0014661301	20.7	0034601980	20.9	0281002576	30.54	0481009036000	21.3
0005423318	30.20	0014662701	20.7	0034602280	20.9	0281002743	30.54	0481009039000	21.3
0005429118	30.60	0014662701	20.8	0034604980	20.7	0281002937	30.63	0481009047000	21.3
0005429618	30.21	001466280	20.7	0034605180	20.7	02.4901.49.00	14.16	0481009050000	21.3
0005429718	30.21	0014662801	20.8	0034667201	20.9	02.4901.49.00	15.11	0481009055000	21.3
0005459209	30.60	0014664001	20.9	0034667201	20.10	0318907580	30.52	0481009059000	21.3
0007631410	30.59	0014664301	20.7	0035423518	30.21	0318907590	30.52	0481009061000	21.3
0007633001	24.6	0014664401	20.7	0035424618	30.21	0318911770	30.52	0481009063000	21.3
0011530220	30.22	0014667601	20.7	003575709	14.16	0318912020	30.52	0481009069000	21.3
0011530420	30.22	0015420518	30.20	003575709	15.11	0318914610	30.52	0481009101000	21.3
0011531620	30.22	0015421718	30.54	003846709	17.17	03.03.00.46	2.17	0481009102000	21.3
0011531820	30.22	0015423318	30.20	003863709	17.17	03.10.00.27	2.8	0481016019	12.2
0011532020	30.22	0015423418	30.20	0040910501	20.2	03.15.00.27	2.16	0481016024	12.2
0011532120	30.61	0015426818	30.20	0041531828	30.55	03.15.00.63	2.16	0481016106	12.2
0011533872	30.22	0015427818	30.20	0041532028	30.56	03.15.00.88	2.16	0481016108	12.2
0011539620	30.22	0015428217	30.68	0041534428	30.64	03.15.00.89	2.16	0481016113	12.2
0011561420	30.22	0015428418	30.20	0041537028	30.55	03.15.00.91	2.17	0481016201	12.2
0012602057	10.4	0015428718	30.20	0041537628	30.55	03.310.08.14.0	31.2	0481016302	12.2
0012603557	10.3	0015428818	30.20	0045455414	30.78	03.310.08.14.0	31.3	0481016303	12.2
0012608457	10.3	0015451809	30.71	004667101	20.7	03.310.08.15.0	31.2	0481016308	12.2
0012950106	16.2	0015454909	30.71	0049971747	32.2	03.310.08.18.0	31.2	0481016309	12.2
0012950806	16.4	0015458409	30.71	0049971847	32.2	03.310.08.53.0	31.2	0481016401	12.2
0012952506	16.3	0018302184	7.4	0061530628	30.81	03.310.09.34.0	31.2	0481016601	12.2
0012952906	16.3	0020526090	26.14	0061531228	30.65	03.310.09.39.0	31.2	0481016603	12.2
0012953006	16.4	0020527090	26.14	0065420318	30.56	03.809.16.00	2.16	0481016702	12.2
0012955206	16.2	0020530090	26.14	0071530828	30.68	03.809.16.01	2.16	0481026005000	23.4
0012955306	16.3	0022606157	10.4	0091532928	30.65	03.812.16.20	2.17	0481026019000	23.4
0012957406	16.2	0022606257	10.4	0109977347	32.2	03.812.16.27	2.17	0481026021000	23.4
0012959106	16.2	0022950707	16.5	01175656	20.4	03.94.00.05	2.18	0481026022000	23.4
0012959506	16.2	0024551207	11.4	0125420517	30.68	03.95.00.38	2.18	0481026023000	23.4
0012959606	16.2	0024600880	20.7	0155422417	30.61	030601M2	7.2	0481026026000	23.4
0014317114	16.2	0024601380	20.10	0233170100	30.6	3061102	7.2	0481026027000	23.4
0014317214	16.2	0024601580	20.9	0233170500	30.6	0331008510	31.2	0481026032000	23.4
0014317314	16.2	0024603180	20.9	0233170700	30.6	0331009380	31.2	0481026302000	23.4
0014317514	16.2	0024603980	20.7	0233264200	7.4	0348792	20.11	0481026303000	23.4
0014318514	16.2	0024604080	20.7	0233304200	7.4	0390487	16.4	0481026306000	23.4
0014600580	20.7	0024604680	20.8	02479001	16.3	0394443	20.11	0481026307000	23.4
001460058080	20.7	0024605180	20.9	0249014900	15.11	043831N00	4.3	0481036105000	15.2
0014602880	20.7	0024605380	20.8	0260242	16.4	0440020036	20.2	0481036117000	15.2

Cross Reference	Page	Cross Reference	Page	Cross Reference	Page	Cross Reference	Page	Cross Reference	Page
0481036206000	15.2	0481061228000	27.6	0481064601	9.5	0486000105	30.30	0486203019	17.9
0481039101	11.3	0481061230000	27.6	0481064603	9.5	0486000107	30.5	0486203022	17.9
0481039102	11.3	0481061231000	27.6	0481064701	9.5	0486000120	30.3	0486203023	17.9
0481039104	11.3	0481061233000	27.6	0481064702	9.5	0486000121	30.3	0486203024	17.9
0481039105	11.3	0481061245000	27.6	0481065004000	15.2	0486000128	30.3	0486203025	17.9
0481039106	11.3	0481061248000	27.6	0481065101000	15.2	0486000129000	30.2	0486203026	17.9
0481039116	11.3	0481062005	18.2	0481065102000	15.2	0486000132100	30.3	0486203028	17.9
0481039117	11.3	0481062006	18.2	0481065103000	15.2	0486000135000	30.2	0486203030	17.9
0481039201000	11.3	0481062104	18.2	0481099011000	15.2	0486000136	30.3	0486203031	17.9
0481039202000	11.3	0481062105	18.2	0481099012000	15.2	0486000183	30.12	0486203032	17.9
0481039204000	11.3	0481062107	18.2	0481500007000	8.3	0486000237	30.5	0486203033	17.9
0481039209000	11.3	0481062109	18.2	0481500101000	8.3	0486000238	30.2	0486203034	17.9
0481039210000	11.3	0481062110	18.2	0481500102000	8.3	0486000238N00	30.2	0486204001	17.10
0481039211000	11.3	0481062201	18.2	0482005018000	24.2	0486000239	30.4	0486204002	17.10
0481039213000	11.3	0481062209	18.2	0482006006000	24.2	0486000239N00	30.4	0486204004	17.10
0481039214000	11.3	0481062301	18.2	0482018002000	24.2	0486000240	30.2	0486204005	17.10
0481039216000	11.3	0481062303	18.2	0482020002000	24.2	0486000241	30.2	0486204006	17.10
0481039219000	11.3	0481062307	18.2	0482023504000	2.17	0486000242	30.2	0486204008	17.10
0481039221000	11.3	0481062308	18.2	0483004201000	16.2	0486000256	30.5	0486204009	17.10
0481039222000	11.3	0481062309	18.2	0483004401000	16.2	0486000257	30.5	0486204010	17.10
0481039225000	11.3	0481062310	18.2	0483004501000	16.2	0486000258	30.3	0486204012	17.10
0481039237000	11.3	0481062312	18.2	0483004601000	16.2	0486000259	30.4	0486204016	17.10
0481039260000	11.3	0481062317	18.2	0483004701000	16.2	0486000260	30.4	0486204017	17.10
0481039268000	11.3	0481062401	18.2	0483005011100	5.16	0486000261	30.4	0486204018	17.10
0481039269000	11.3	0481062405	18.2	0484205006N00	30.54	0486000262000	30.4	0486204019	17.10
0481039273000	11.3	0481062412	18.2	0484210001000	90.9	0486000262N00	30.4	0486204020	17.10
0481042101	11.3	0481062413	18.2	0484210017000	90.9	0486000263000	30.5	0486204021	17.10
0481042102	11.3	0481063036000	22.2	0484451005	1.12	0486000263N00	30.5	0486204023	17.10
0481042103	11.3	0481063037000	22.2	0484451006	1.12	0486000276N00	30.5	0486204024	17.10
0481042104	11.3	0481063041000	22.2	0484451007	1.12	0486000277N00	30.5	0486204025	17.10
0481042105	11.3	0481064002	9.3	0484451008	1.12	0486000284	30.5	0486204026	17.10
0481042106	11.3	0481064003	9.3	0484451009	1.12	0486002001	30.4	0486205001	17.10
0481042107	11.3	0481064005	9.3	0484451013	1.12	0486002001000	30.17	0486205002	17.10
0481042108	11.3	0481064006	9.3	0484460022000	1.2	0486002002	30.4	0486205003	17.10
0481042201000	11.3	0481064011	9.3	0484460023000	1.2	0486002002000	30.17	0486205004	17.10
0481042211000	11.3	0481064016	9.3	0484460153000	1.2	0486002003	30.4	0486205006	17.10
0481042212000	11.3	048106410	9.4	0484460165000	1.2	0486002004	30.4	0486205010	17.10
0481042214090	11.3	0481064101	9.3	0484460170000	1.2	0486002005	30.3	0486205011	17.10
0481042225000	11.3	0481064103	9.3	0484460177000	1.2	0486200002	9.5	0486205014	17.10
0481061004000	27.5	0481064105	9.4	0484460186000	1.2	0486200004	9.5	0486205015	17.10
0481061005000	27.5	0481064106	9.4	0484460204000	1.2	0486200008	9.5	0486205016	17.10
0481061019000	27.5	0481064107	9.4	0486000000000	30.5	0486200009	9.5	0486205017	17.10
0481061020000	27.5	0481064108	9.4	04860000045	30.2	0486200101	9.5	0486205019	17.10
0481061023000	27.5	0481064110	9.4	04860000051	30.2	0486200104X50	9.5	0486205020	17.10
0481061025000	27.5	0481064113	9.4	04860000052	30.2	0486200202N50	9.5	0486205022	17.10
0481061205000	27.5	0481064115	9.4	04860000053	30.2	0486200241	30.2	05.174.52.61.0	25.38
0481061209000	27.5	0481064201	9.4	04860000071000	30.5	0486203002	17.9	05.310.07.30.1	31.2
0481061210000	27.5	0481064205	9.4	04860000100	30.3	0486203004	17.9	05.444.10.37.0	2.2
0481061212000	27.5	0481064206	9.4	04860000101	30.3	0486203005	17.9	05.444.10.38.0	2.2
0481061213000	27.6	0481064209	9.4	04860000102	30.3	0486203006	17.9	05.444.40.07.3	2.2
0481061214000	27.6	0481064210	9.4	04860000103	30.4	0486203009	17.9	05.444.40.08.3	2.2
0481061215000	27.6	0481064212	9.4	04860000103000	30.18	0486203012	17.9	05.444.41.03.0	2.2
0481061219000	27.6	0481064214	9.4	0486001033	30.2	0486203013	17.9	05.444.41.04.0	2.2
0481061220000	27.6	0481064301	9.4	0486000104	30.4	0486203014	17.9	05.444.44.01.0	2.2
0481061225000	27.6	0481064401	9.4	0486000104000	30.18	0486203016	17.9	05.444.44.02.0	2.2
0481061226000	27.6	0481064405	9.4	0486000105	30.5	0486203017	17.9	0500004201000	14.4

CROSS REFERENCES

Manufacturers Part Numbers are for the purpose of reference only.

Cross Reference	Page	Cross Reference	Page	Cross Reference	Page	Cross Reference	Page	Cross Reference	Page
0500005001000	14.4	09319438	25.34	10574930	5.17	1185145	11.2	1195601	20.13
0500005002000	14.4	09319440	25.32	10574936	5.17	1185301	2.23	1195701	20.13
0500005006000	14.4	0986897	20.7	1068913	8.4	1186260	2.23	1195759	30.32
0500005007000	14.4	1.487.010.063	2.26	1068951	10.5	1186261	2.23	1195801	20.13
0500005011000	14.4	1.487.010.117	2.26	1068952	10.5	1186699-01	2.4	1195901	20.13
0500005012000	14.4	1.487.010.128	2.26	1075889	31.7	1186722SP	6.46	11971	29.7
0500005017000	14.4	1.487.010.188	2.26	10762618	2.20	1186753	2.18	1205112	6.41
0500005101000	14.5	100001721	25.38	1076760	31.7	1186754	2.18	120927303	2.3
0500005102000	14.5	1000129485	5.7	1077574	30.69	1186883-08	2.4	121150003	2.3
0500005104000	14.5	1000132951AM	5.9	107794	1.10	1186892	22.8	121254003	2.3
0500005105000	14.5	1000133152AM	5.9	1078316	8.2	1186938	15.2	12254	25.9
0501100017000	13.2	1000139593	5.7	1078318	8.2	1188264	2.23	12255	25.9
0501100018000	13.2	1000178631	5.8	1078493	30.58	1188664	21.2	12256	25.9
0501100029000	13.2	1000179039AM	16.7	1079338	30.84	1188743	27.6	1238034	32.2
0501100030000	13.2	1000184461	5.8	1082959	20.12	1188768	9.2	1239411	20.3
0501100031000	13.2	1000274399AM	5.6	1087960	30.58	1188782-01	2.4	125240405	2.3
0501100038100	13.2	1000332424AM	5.6	1087962	30.59	1188783	2.4	125240406	2.3
0501100041100	13.2	1000332427AM	5.4	1087963	30.57	1188823	2.18	1252439	30.80
0501100052000	13.2	1000349603AM	5.6	1087964	30.59	1188845	2.18	1255105	16.3
0501100055000	13.2	1000396262AM	5.4	1087967	30.55	1189072-01	2.17	12602057	10.3
0501100407100	1.2	1000409870	5.8	1089172	30.29	1189096	15.2	1275083	32.2
0501100408000	1.2	1000434990AM	5.4	1089552	32.3	1189097	15.2	1275084	32.2
0501210058	30.73	1000443286AM	5.9	1089887	20.13	1189289	6.47	1278342	16.2
0501219315	10.5	1000443297AM	5.9	109264	23.2	1189308	6.8	1285259	10.6
0501317523	2.20	1000479403AM	5.7	109740	16.3	1189389	9.2	1285260	10.6
0504002107000	14.14	1000509122AM	5.4	111602410-01	5.15	1189392000	11.2	12877	29.4
0504002113100	14.14	1000510486AM	5.4	111602410-10	5.15	1189393000	11.2	1291190	16.2
0504003001000	14.14	1000579118AM	5.4	111602410-20	5.15	1189394000	11.2	1291227	20.3
0516280	20.7	100101047	25.38	111602410-32	5.15	1189395000	11.2	1291509	16.3
0526663	20.3	101256	6.46	111602410-40	5.15	1189396000	11.2	12934	29.4
0531008440	31.2	1013383000	6.19	1111419000	22.4	1189421SP	16.5	1297004	10.3
0531008441	31.2	1013393000	6.19	1111459	30.79	1189432	16.10	12999665	3A.3
0544438010	2.2	101930N	23.3	1111730000	14.5	1189449	2.18	1304725	30.66
0544438020	2.2	102166	23.2	1111850000	15.3	1189458	2.18	1305348	20.11
0544439010	2.2	10223312	7.3	1111950000	15.3	1189470	2.4	1305349	20.11
0544439020	2.2	10223312	26.8	1111951000	15.3	1189489000	11.2	1308495	20.11
0544440010	2.2	1023275000	9.6	1111954000	15.3	1189492	9.2	1309315	10.7
0544440020	2.2	1023277000	9.6	1111961000	15.3	1189497	6.46	1315691	30.8
0544442010	2.2	1025285/F	8.9	1111962000AT	15.3	1189499	6.2	1318858	10.7
0544442020	2.2	102998	23.2	1111980000	15.3	1190023	2.23	1319557	10.5
0544443020	2.2	103833	23.2	1111984010	14.16	11927	29.6	132422	20.11
0544446010	2.2	1043110000	12.3	1111984010	15.11	1194101	27.6	1326649	30.55
0544446020	2.2	1043130000	12.3	1111995000AT	15.3	1194122	2.4	1327199	30.64
059512309	30.51	10571028	20.11	1111999000	15.3	1194130	7.2	1332653	20.11
0647602	20.3	10571297	20.11	1112001000	15.3	1194131	7.2	1333790	20.11
0691041	16.3	10571364	20.11	1112050	20.11	1194135	6.16	1334037	8.3
0750132007	7.5	10571370	20.11	1114847	30.27	1194138	2.4	1334961	31.3
0751820	16.4	10571382	20.11	1123465	20.11	1194186	16.5	1335063	31.3
0863297	20.11	10571393	20.11	1123465	20.12	1194215X50	6.46	1335270008	11.4
09.362.72.11.0	3.7	10571394	20.11	1123466	20.11	1194220000	12.3	1339412	16.6
09.362.72.12.0	3.7	10571431	20.11	1148201	20.7	1194339	22.8	1339680	31.6
09.362.72.13.1	3.7	10571432	20.11	1148301	20.7	1194354	6.16	1339680	31.7
09.362.72.14.1	3.7	10571435	20.11	11492	29.9	1194421	6.16	1340232	8.2
0928400627	30.73	10571436	20.11	1154219	10.3	1194454	6.16	1340320	32.2
0928400670	30.73	10571437	20.11	11715	29.10	1194487	6.16	1340321	32.2
09319437	25.34	10574929	5.17	11757	29.9	1194525SP	1.11	1342971	30.26

Cross Reference	Page	Cross Reference	Page	Cross Reference	Page	Cross Reference	Page	Cross Reference	Page
1348509	30.71	1406643	5.14	1439666	30.28	1491408	30.82	1530701	30.28
1348734	16.6	1407023	5.14	1439958	20.11	1493771	8.8	1530702	30.28
1349016	31.6	1407118	5.14	1441273	30.28	1504006	20.12	1530703	30.27
1350462	30.29	1407692	30.7	1441274	30.27	1504929	30.6	1530704	30.26
1353493	30.28	1408320	5.14	1441275	30.28	1505211	30.6	1530705	30.27
1355747	30.28	1408387	5.14	1441276	30.28	1505212	30.7	1530706	30.28
1356604	30.29	1408824	5.14	1441277	30.29	1505214	30.8	1530709	30.29
1356751	30.69	1409260	5.14	1441278	30.29	1505215	30.7	1530710	30.29
1358801	16.6	1409284	5.14	1442278	8.2	1506003	30.7	1531360	30.26
1358967	30.69	1409285	5.14	1442296	31.6	1506004	30.6	1531361	30.26
1360842	30.73	1409287	5.14	1442300	31.6	1506004	30.7	1534518	30.30
1361136	16.3	1409391	34.7	1446052	2.20	1507434000000	1.11	1534519	30.27
1361136	16.6	1409391	34.8	1448080	30.79	1515101	20.7	1534520	30.27
1361393	30.8	1409870	5.14	1449771	30.78	1516563	30.79	1534521	30.27
1362071	10.7	1414025	20.2	1450054	20.4	1517455	30.8	1534522	30.27
1362168	30.54	1420005	30.71	1450194	30.71	1517945	24.5	1534522	30.29
1365526	30.27	1420362	5.14	1452862	30.68	1518002	30.8	1534525	30.27
1365529	30.28	1420879	5.14	1453597	30.28	1518003	30.8	1534525	30.29
1365935	14.15	1421273	20.11	1453598	30.28	1518007	30.8	1534527	30.26
1368171	8.8	1421322	8.2	1455523	1.11	1518008	30.7	1534528	30.28
1369555	10.7	1421323	8.2	1457275	8.3	1518009	30.7	1535520	30.56
1369975	10.7	1421324	8.2	1457276	8.3	1518010	30.7	1535521	30.68
1369977	10.7	1421325	8.2	1457303	30.63	1518142	20.2	1539298	20.2
1370084	8.8	1421628	20.11	1457304	30.63	1521247	10.4	1545506	30.28
1370127	32.2	1422417	20.11	1457305	30.56	1521248	10.4	1545634	30.69
1371404	20.12	1422449	20.2	1457306	30.68	1521249	10.5	1545635	30.69
1374052	30.66	1422762	5.14	1457708	20.11	1521249	10.10	1546365	30.28
1375382	31.6	1423079	5.14	1457709	20.11	1521394	10.7	1547687	30.27
1375507	20.4	1423968	30.71	1457710	20.11	1522373	32.3	1571297	20.11
1377386	10.7	1423976	30.71	1457711	20.11	15224836	3.5	1571364	20.11
1377930	30.69	1423977	30.71	1471738	30.63	15224836	3.7	1571370	20.11
1378644	30.71	1424371	5.14	1472738	30.71	15224837	3.5	1571382	20.11
1383578	30.69	1426321	30.80	1472739	30.71	15224837	3.7	1571393	20.11
1383580	30.69	1426591	5.14	1478402	30.27	1522895	32.3	1571394	20.11
1387100	30.71	1428442	30.28	1482006	30.26	1523992R	1.11	1571397	20.11
1388000	30.71	1428443	30.28	1482007	30.26	1524830	30.8	1571432	20.11
1391510	1.11	1428446	30.27	1482992	10.7	1525891	30.71	1571435	20.11
1391515	31.3	1428447	30.27	1482996	10.7	1525892	30.71	1571437	20.11
1391516	31.3	1428450	30.26	1482997	10.7	1526158	30.82	1571540	30.59
1391517	31.3	1428451	30.27	1485717	10.7	1526865	10.8	1575405	2.18
1393113	30.68	1428451	30.29	1488083	8.3	1527004	10.7	1578133	30.84
1394465	30.71	1428452	30.29	1488340	30.68	1527108	30.69	1578134	30.84
1395485	16.6	1428453	30.27	14900006015	6.40	1527590	10.4	1581209	16.4
1395692	8.3	1428454	30.28	14900077203	6.40	1527591	10.4	1585013	20.13
1395692	10.10	1428455	30.27	14900085312	6.40	1530090	30.27	158717	30.59
1397682	20.2	1430202	2.20	14900095502	6.40	1530690	30.27	1587787	20.13
1398467	30.61	1431119	30.28	14900107503	6.40	1530691	30.27	1587788	20.13
1398468	30.55	1431120	30.27	14900109402	6.40	1530692	30.27	1587792	32.3
1400071	30.7	1435680	30.73	14900113202	6.40	1530693	30.28	1589231	20.13
1400674	30.29	1437931	30.28	14900127710	6.40	1530694	30.28	1589925	20.13
1401813	20.4	1437932	30.28	14900127710	6.47	1530695	30.28	1591014	20.13
1401926	20.4	1438702	10.7	14900127711	6.40	1530696	30.26	1591098	20.13
1402943	30.69	1438785	30.29	14900128010	6.40	1530697	30.28	1591903	32.3
1402944	30.69	1438786	30.29	14900140911	6.40	1530698	30.28	1594037	30.58
1403060	30.69	1438888	30.27	14900148802	6.40	1530699	30.28	1594039	30.59
1405826	30.7	1438889	30.28	14900172710	6.40	1530700	30.27	1594040	30.57

CROSS REFERENCES

Manufacturers Part Numbers are for the purpose of reference only.

Cross Reference	Page	Cross Reference	Page	Cross Reference	Page	Cross Reference	Page	Cross Reference	Page
1594041	30.59	1673078	30.67	1805821	31.3	1892063	30.27	20382511	30.58
1594138	30.84	1673109	10.7	1805822	31.3	1892064	30.27	20382517	30.51
1594225	30.83	1687826	20.4	1805823	31.3	1892065	30.30	20382518	30.58
1594228	30.83	1695495	20.2	1805824	31.3	1892068	30.27	20382529	30.72
1594229	30.70	1696444	25.40	1810690	30.80	1892070	30.27	20390737	30.31
1605904	20.13	1696446	25.40	1810691	30.80	1892072	30.30	20392016	31.7
1606786	30.58	1696448	25.40	1819790	34.8	1900069	32.2	20399	29.10
1606834	2.20	1696449	25.40	1819790	34.9	1908536	34.6	204029106100	31.3
1607252	30.58	1696453	25.40	1819798	34.8	1911032	30.72	20410321	30.72
1608006	2.20	1696924	25.40	1819798	34.9	1917514	30.85	20411199	8.9
1609886	10.3	1698346	25.40	1826279	30.55	1919065	10.7	20424051	30.58
1610367	20.13	1703574	34.7	1826281	30.75	1925363	1.12	20424056	30.58
1610566	8.2	1703574	34.8	1827058	30.80	1927179	34.10	20424060	30.59
1610568	8.2	1705572	34.2	1833030	10.6	1931444	5.17	20424066	30.59
1610570	8.2	1710806	34.3	1836059	34.2	19339	29.3	20424109	31.7
1610765	32.3	1727377	10.7	1836060	34.2	1941956	4.4	20428456	30.70
1612230	30.83	1729587	30.30	1836061	34.2	1942001	20.3	20428459	30.57
1613280	30.59	1729792	30.27	1849429	5.17	1952532	34.8	20428462	30.66
1614351	16.4	1729793	30.27	1852113	30.79	1952532	34.9	20428941	30.33
1616808	24.4	1729794	30.27	1853436	30.79	1952565	34.3	20428942	30.33
1618946	30.83	1729798	30.26	1862600	30.8	1954301	20.13	20428946	30.32
1620067	14.2	1729800	30.26	1862787	30.56	1955801	20.3	20428948	30.32
1620462	16.4	1734012	8.8	1862797	30.56	19607	29.4	20429956	30.83
1622983	30.58	1740757	30.64	1862798	30.69	19621	29.3	20440372	20.3
1622985	30.59	1741027	7.4	1862799	30.69	19632	20.5	20441871	20.3
1622986	30.57	1741865	30.51	1862800	30.69	1975291	34.8	20443824	30.74
1622987	30.59	1742947	30.79	1862892	30.68	1975291	34.9	20452439	30.70
1622989	30.58	1743181	30.72	1862895	30.57	19781	29.2	20453450	20.3
1623785	30.58	1753208	34.8	1865315	30.83	19857	29.6	20453450	20.13
1624361	30.83	1753208	34.9	1869290	30.8	1999959	30.79	20475038	5.19
1624368	30.84	1765294	30.27	1870628	30.47	2006243	34.2	20478260	30.57
1624783	30.64	1765295	30.28	1871772	30.82	2006245	34.2	20483920	10.9
1624784	30.64	1767616	30.57	1872086	34.6	201002001	23.5	20484676	30.70
1628208	20.12	1771230	30.79	1874641	30.29	201020020	23.5	20484678	30.70
1628218	16.4	1774004	30.72	1874642	30.29	201149033	30.54	20488052	10.7
1641625	6.41	1777165	30.78	1881260	30.68	2011648	34.2	20488058	10.7
1642176808	5.14	1778554	30.8	1884529	30.53	2011649	34.2	20488061	10.8
1652528	30.54	1781197	30.64	1888075	30.79	2020691	34.6	20488063	10.7
1653070	10.4	1782596	34.6	1890167	30.29	20208386	30.72	20488065	10.7
1653156	10.5	1783287	30.62	1890168	30.29	2022257	6.41	20488079	10.7
1653360	10.4	1783288	30.62	1890169	30.29	2022259	6.41	20490824	30.32
1654350	10.4	1784588	30.26	1890170	30.29	2023059	5.17	20493844	10.7
1655855	10.7	1784636	30.69	1890171	30.29	20350652	20.12	20498094	30.72
1657638	31.3	1784637	30.69	1892003	30.26	2037304	5.17	20499340	30.70
1662798	8.8	1784638	30.69	1892028	30.27	20374280	30.57	205001001	22.3
1662926	30.59	1786995	10.3	1892047	30.27	20374281	30.84	20504685	30.71
1662938	30.83	1787155	30.56	1892048	30.27	20374282	30.62	20508011	30.62
1665981	10.8	1787183	30.28	1892049	30.28	20375013	30.70	20509864	30.31
1669297	10.5	1788333	30.81	1892050	30.28	20382500	30.59	20509869	30.31
1669298	10.5	1788333	30.82	1892052	30.28	20382504	30.58	20513343	30.62
1669324	10.5	1793378	34.2	1892053	30.28	20382505	30.58	2051403	30.79
1669419	10.4	1790708	31.6	1892054	30.30	20382506	30.58	20514065	30.70
1669420	10.4	1797644	20.4	1892056	30.28	20382507	30.59	20514417	30.72
1669488	16.4	1797650	20.2	1892057	30.26	20382508	30.57	20514511	14.2
1672231	10.5	1800442	16.7	1892058	30.29	20382509	30.59	20514657	8.8
1672299	10.7	1805197	30.73	1892059	30.28	20382510	30.58	20520111	30.85

Cross Reference	Page	Cross Reference	Page	Cross Reference	Page	Cross Reference	Page	Cross Reference	Page
20524936	30.54	20829689	30.57	21068286	30.57	21343551	5.19	21746206	30.70
20528336	30.57	20835	3A.7	2107185	20.6	21343555	5.19	21789730	5.19
20528657	30.33	20835246	16.4	21073025	10.9	21343559	5.19	21806	29.8
20528660	30.32	20850557	14.14	21073035	10.9	21343565	5.19	21807	29.2
20528661	30.31	20853399	30.59	2108142	20.12	21343575	5.19	21915485	30.74
20528662	30.31	20861966	30.63	2108156	20.12	21343579	5.19	21937969	10.9
20545996	5.19	20869391	30.72	2108165	20.12	21343589	5.19	21937971	10.9
20552760	30.56	20870050	30.72	21095380	30.59	21345733	30.59	2196849	30.34
20553587	16.4	20873117	34.5	21097072	30.33	21360516	30.32	21991154	8.8
20554951	30.31	20873117	34.7	21097076	30.33	21361890	30.31	21991157	8.8
20554952	30.31	20873395	34.5	21097077	30.33	21361900	30.31	22017	3A.7
20554956	30.31	20873395	34.7	21097978	30.57	21361902	30.31	220222	21.2
20554957	30.31	20873675	90.12	21116874	30.74	21363477	30.32	22083	29.6
20554958	30.33	20875073	30.72	21116880	30.74	21363478	30.32	22209517	34.8
20554959	30.33	20877958	34.11	21150949	30.32	21363479	30.32	22219283	34.5
20555313	90.9	2087965	30.58	21150950	30.32	21363484	30.32	22219283	34.7
20562642	30.63	20886108	30.70	21152083	30.32	21363487	30.32	22219284	34.6
20566832	30.31	20889280	30.84	21152088	30.32	21363493	30.32	22219284	34.7
20576626	30.83	20889693	30.74	21159001	30.66	21363495	30.32	22194741	14.2
20576626	30.84	20893518	30.74	21164790	30.85	21363496	30.31	2223488	31.6
20583428	14.2	20898038	30.70	21164792	30.85	21364022	30.32	2225901	20.13
20583477	30.72	20902690	20.3	21168	29.10	21379916	30.33	22262	3A.7
20589620	30.34	20902690	20.13	21188995	20.13	21385	29.4	22263	3A.7
20593	29.2	20902965	20.13	211171988	22.7	21390986	30.84	22303391	34.7
2064774	30.53	20905373	30.70	21210537	31.7	2139930	34.2	22327063	8.8
2064775	30.53	20909613	30.56	21212472	2.2	21399626	30.66	22327072	8.8
20700996	5.19	20912144	30.57	21213033	31.6	21403962	30.72	22329559	30.57
207012001	26.2	20913287	8.4	21213316	31.6	21412472	30.84	223443	16.4
207012021	26.2	20916171	30.32	21223339	2.2	21412848	1.11	2236406	34.3
207013001	26.2	20916173	30.32	21225020	30.85	21449	29.7	2236408	34.3
207013021	26.2	20921220	30.34	2122929	25.33	21455	29.7	22391563	34.6
2070351745	30.70	20933795	34.7	21229290	25.33	21456377	10.9	22391563	34.8
20706889	30.57	20933795	34.10	21247147	30.32	21456378	10.9	22422785	30.57
20709205	10.9	20941236	21.3	21247154	30.32	21458307	21.3	2247379	34.6
20713630	34.8	20976003	90.12	21247157	30.27	21516229	34.8	225211001K	3.5
20713630	34.11	20997341	20.3	21247157	30.31	21516229	34.11	225211002K	3.5
20720686	30.72	20998367	90.12	21247161	30.31	21521353	30.66	22537018	31.7
20726986	30.51	21002852	5.19	21253672	14.2	21539993	20.3	22583048	10.9
20732821	30.32	21002856	5.19	21285	29.3	21540602	30.70	22606157	10.3
20732822	30.32	21002860	5.19	21285163	30.85	2155201	20.6	22647913	10.9
20748450	90.9	21002866	5.19	21296829	30.33	21567737	34.6	22647926	10.9
20752310	20.3	21002876	5.19	21296851	30.34	21567737	34.7	2265673	34.8
20761735	30.57	21002880	5.19	21296853	30.34	21576	3A.7	2265673	34.11
20771578	30.72	21002890	5.19	21302639	30.70	21583789	1.11	2265872	30.82
20775168	10.4	21002896	5.19	21314741	34.7	21585711	14.2	22677703	30.57
20775173	10.4	21009	29.6	21314741	34.10	21596642	8.9	227908539R	34.6
20783875	10.4	21010707	30.85	21314742	34.7	2160199	7.4	227905433R	34.6
20796740	30.70	21024533	10.9	21314742	34.10	21636091	34.7	228078	21.2
20796744	30.70	21024535	10.9	21318083	30.59	21643575	14.2	22814	29.3
208002001	22.7	21024539	10.7	21318366	10.3	21643804	30.72	22822	29.7
208003001	22.7	21031448	8.8	2131963	5.17	21707054	8.8	22827992	34.6
208003031	22.7	21042447	30.66	21332695	24.7	21734245	34.8	22827992	34.7
208003041	22.7	2105277	20.11	21332695	34.8	21734245	34.11	22827993	34.5
208004021	22.7	2105480	20.12	21333097	34.7	217380	21.2	22827993	34.7
20803650	30.70	2105576	20.3	21333097	34.11	21738132	34.7	22827995	34.5
2082082	5.17	21067551	20.3	21343543	5.19	21738132	34.9	22827995	34.6

CROSS REFERENCES

Manufacturers Part Numbers are for the purpose of reference only.

Cross Reference	Page	Cross Reference	Page	Cross Reference	Page	Cross Reference	Page	Cross Reference	Page
22827995	34.5	249014900	15.11	272910	25.40	286968X50	1.10	29127	3A.6
22827995	34.7	25043	29.10	272921	6.28	287034	6.30	29129	3A.3
22851845	34.7	25073	29.9	273455	6.28	2871880	34.8	29131	3A.4
22851845	34.8	25139	29.6	274421	2.4	2872298	34.2	29136	3A.4
228600	30.85	25210	29.10	274422	2.4	287631	6.47	29137	3A.4
22889891	24.4	25318	29.4	274423	2.4	2879901	20.12	29142	3A.4
22904	29.9	25353	29.9	274424	2.4	288383	9.2	29143	3A.4
2290706	5.17	25395	29.4	274746	30.85	289257	6.28	29145	3A.3
2293964	34.3	25447	29.5	274785	21.2	28969	29.9	29148	3A.3
2293965	34.3	254811160	2.15	274971	25.38	289714N	22.6	29151	3A.4
2294290	34.6	255028	20.11	274996	22.7	289924	6.46	29158	3A.4
2294291	34.6	25551	29.7	274997	22.7	29011	3A.3	29159	3A.4
229501	9.2	25721	29.5	274998	22.7	29013	3A.3	29160	3A.4
2296798	34.5	25918	3A.7	274999	22.7	29014	3A.3	29162	3A.4
2296798	34.7	26024	29.4	275200DK	11.2	29017	3A.3	29163	3A.3
2296799	34.6	26036	29.7	275491DK	11.2	29024	3A.3	29165	3A.4
229800	9.2	26058	29.10	275508DK	11.2	29026	3A.3	29167	3A.3
23.812.16.03	2.17	262625	30.85	27558	29.7	29029	3A.3	29167	3A.4
23.812.16.04	2.17	262694	30.85	27582	29.9	29030	3A.3	29169	3A.5
23.812.16.07	2.16	264432	25.38	27631	29.7	29032	3A.3	29171	3A.4
23.814.16.00	2.17	264433	25.38	276313	10.7	29033	3A.3	29171	3A.5
23.814.24.04	2.17	265050102	30.12	27648	29.8	29039	3A.3	29173	3A.5
23.818.24.05	2.17	265050103	30.12	276634	10.7	29042	3A.3	29174	3A.5
23.820.24.11	2.17	2655852	34.8	276825	10.7	29043	3A.3	29175	3A.5
23.822.24.05	2.17	26691	29.10	276826	10.7	29050	3A.3	29175	3A.7
23069	29.10	267026	25.38	276832	10.7	29051	3A.3	29177	3A.5
230762000	2.17	267027	25.38	277144	21.2	29055	3A.3	29179	3A.3
231938	32.2	267051	11.2	277147	21.2	29056	3A.3	29181	3A.5
23197503186AM	5.19	267083	25.38	277148	21.2	29059	3A.3	29183	3A.3
23197603252AM	5.19	267084	25.38	277227	21.2	29061	3A.3	29184	3A.3
23493	29.6	267098	11.2	277486DK	11.2	29067	3A.3	29192	3A.5
23439998	8.4	267101	11.2	277516	7.2	29077	3A.3	29195	3A.5
2388630	30.73	267114	23.3	277971	21.2	29083	3A.3	29195	3A.7
2392193	5.17	267121	1.3	278426	21.2	29087	3A.3	29197	3A.3
2392281	5.17	267268	32.3	27892	29.3	29088	3A.3	29200	3A.5
23976	29.5	26779	29.8	27953	29.6	29090	3A.3	29201	3A.3
23990	3A.7	267858	10.4	279750	9.2	29091	3A.3	29203	3A.5
23994	29.5	26823	29.9	279919	23.3	29092	3A.3	29204	3A.5
23996	29.4	26826	29.2	280375DK	23.2	29093	3A.3	29207	3A.5
24060006	30.23	26831	29.2	280722	6.30	29094	3A.3	29211	3A.5
24240	29.4	26841	29.2	280728	6.30	29095	3A.3	29215	3A.4
24240031	30.23	26842	29.2	280737	6.30	29096	3A.3	29219	3A.5
24242	29.4	269733	11.2	28091	29.7	29100	3A.3	29223	3A.6
24243	29.4	269827	1.3	281672	23.3	29105	3A.3	29226	3A.5
24382	29.8	271483	23.3	281857	21.2	29108	3A.3	29227	3A.5
2441305	5.17	271721	6.28	281865N	23.3	29109	3A.3	29228	3A.5
24424075	20.13	271906	21.2	281966	25.39	29113	3A.3	29229	3A.6
24424110	30.66	272071	23.3	281967	25.39	29115	3A.3	29230	3A.6
24424123	20.13	2722701	34.8	281986	32.2	29116	3A.3	29231	3A.6
24424124	20.13	272489	2.23	28330	29.4	29117	3A.3	29232	3A.6
24424124	20.14	272897SP	1.11	285977	6.30	29121	3A.3	29237	3A.4
24484	3A.7	272905	25.40	286104	6.30	29122	3A.3	29244	3A.6
24485	3A.7	272906	25.40	286171	9.2	29123	3A.4	29245	3A.6
24486	3A.7	272907	25.40	286546	6.30	29124	3A.4	29246	3A.5
2450508	5.17	272908	25.40	286773	9.2	29125	3A.4	29246	3A.6
24581	29.5	272909	25.40	286880	9.2	29126	3A.4	29247	3A.6

Cross Reference	Page	Cross Reference	Page	Cross Reference	Page	Cross Reference	Page	Cross Reference	Page
29253	3A.6	300278	32.3	31932124	2.20	338071131	26.4	352047045	13.7
29256	3A.6	30078	29.3	3195815	30.62	33980	29.2	352047100	13.7
29267	3A.6	30290	29.2	31959	29.9	33981	29.3	352047200	13.7
29271	3A.6	3029902	7.2	3197870	30.58	33983	29.8	352049100	13.7
29274	3A.5	3034073	30.58	3197871	30.59	3400034201	24.2	352051100	13.7
29274	3A.7	3040102	7.2	320060001	9.7	340005001	24.2	352051200	13.7
292766	32.2	3040502	7.2	320060101	9.7	340011001	24.2	352053001	26.5
29279	3A.6	3040602	7.2	320060103	9.7	340079003	24.2	352054E35	13.7
29284	3A.6	3040802	7.2	320060111	9.7	34025	29.3	352054X53	13.7
29291	3A.5	3041102	7.2	320060113	9.7	34026	29.2	3520611011	13.7
29294	3A.5	3041302	7.2	320060122	9.7	34027	29.3	352061111	13.7
292962	16.4	304552	32.2	320060123	9.7	34032	29.2	352062101	13.7
29302	3A.3	30592	29.4	320063121	9.7	34034	29.2	352062111	13.7
29308	3A.6	3060102	7.2	320063122	9.7	34035	29.3	352067001	26.5
29316	3A.5	3080008100	3.7	321019001	5.15	34047	29.2	352067101	26.5
29317	3A.5	3080008200	3.7	321023001	5.15	341011021	24.3	352067121	26.5
29328	3A.6	3090954	25.40	321025001	5.15	341032011	24.3	352067601	26.5
29331	3A.6	3091700	25.40	321030001	5.15	34528	29.5	352070111	13.7
29332	3A.6	3091916	10.5	322GC45	20.2	3454660001	20.8	352075001	26.5
29337	3A.6	3092459	20.3	322GC49A	20.2	34929	29.8	352080001	13.7
29340	3A.6	3092815	30.74	329007001	26.2	350026002	23.5	3521300215	6.39
29345	3A.7	30969	29.9	329020201	27.2	350036011	22.8	3521300615	6.39
29355	3A.5	3097092	25.40	329020241	27.2	350036211	22.8	355018001	23.5
29357	3A.3	3097099	25.40	329020261	27.2	350063211	22.6	355018011	23.5
29374	3A.3	3097299	25.40	329024071	27.2	351008022	23.5	355023061	23.5
29434	29.5	30986	29.8	332GC45	20.2	351008023	23.5	355071001	27.2
29454	29.5	30998	29.2	333001201	22.4	351008122	23.5	355087001	27.2
295035	21.2	30999	29.3	33397	29.9	351008123	23.5	355094001	27.2
295036	22.3	310005011	1.13	33416	29.3	351009021	23.5	35513	29.3
295071	23.2	312013014	11.3	33576	29.5	351009121	23.5	355973	16.4
295183	25.39	3127318	16.3	33583	29.5	351012001	15.3	356001011	22.8
295184	25.39	31309	29.8	33772	29.9	351014001	15.3	356022001	22.8
295198	23.2	314014031	22.2	338021001	26.3	351022001	23.5	356022011	22.8
295199	23.2	314059001	18.2	338050101	26.3	351033001	23.5	356022031	22.8
295249	23.2	314060001	18.2	338051101	26.3	3515093	30.63	356023001	22.8
295295	23.2	314572	30.72	338051102	26.3	352006201	26.4	35605	29.5
295358	22.3	315016001	1.13	338051111	26.3	352011102	15.3	35611	29.5
295358	22.4	3165985	20.3	338051112	26.3	352018001	26.2	35611	29.6
295393	21.2	3171490	30.62	338051121	26.3	352019001	26.2	356743	2.18
295452	21.2	3172193	20.12	338051141	26.3	352019011	26.2	3575400317	30.22
295472	21.2	3172197	20.12	338052101	26.3	352022001	26.5	3575400417	30.22
295528	23.3	3172199	20.12	338053101	26.3	352025011	26.5	3575400917	30.22
295554	2.4	3172488	20.12	338054001	26.3	352026011	26.2	3575709	15.11
295555	2.4	3172490	20.12	338054011	26.3	352028011	13.7	35948	29.7
295556	2.4	3172499	20.12	338055101	26.4	352028012	13.7	360009141	13.7
295567	25.39	3172522	30.58	338056001	26.4	352028014	13.7	360009241	13.7
295579	9.2	3172524	30.56	338057101	26.4	352029001	26.2	360009341	13.7
29614	29.7	3173630	30.54	338058101	26.4	352032030	13.7	360113	29.3
29747	3A.7	3173797	30.66	338058121	26.4	352032035	13.7	360226	29.4
29799	29.4	3175135	30.74	338058121	26.10	352042001	26.5	360596	29.8
29814	29.7	3182312	20.12	338059101	26.4	352044001	26.5	360669	29.6
29815	29.8	31887	29.10	338061201	26.4	352045001	26.5	360678	29.8
29835	3A.7	3192255	10.7	338062101	26.4	352046001	26.5	360689	29.6
29839	3A.7	3192256	10.7	338062201	26.4	352047030	13.7	360872	29.6
300130	20.12	3192261	10.7	338071001	26.4	352047032	13.7	360924	29.7
300278	32.2	3192384	10.4	338071101	26.4	352047035	13.7	361010	29.6

CROSS REFERENCES

Manufacturers Part Numbers are for the purpose of reference only.

Cross Reference	Page	Cross Reference	Page	Cross Reference	Page	Cross Reference	Page	Cross Reference	Page
361089	29.6	4005000700	17.3	40225026	3.8	4115530030	6.21	4123520030	6.42
36174	29.5	4005000810	17.3	4029100101	31.3	4115530030	6.42	4123520030	6.48
361799	30.61	4005001030	17.3	4029104200	30.26	41200561	30.11	4123520040	6.9
36271206004	30.13	4006064100	90.11	4029106300	31.3	41200584	30.11	4123520050	6.9
36271206005	30.13	40100001	3.8	4029106300	31.5	41200611	30.11	4123520060	6.9
364338011	17.19	40100002	3.8	4029106400	30.26	41200708	14.15	4123520070	6.9
364344001	17.19	40160015	3.8	4029106900	31.3	41211005	16.4	4123520080	6.10
364352021	17.19	40160016	3.8	4029107000	31.3	41211093	20.5	4123520090	6.9
364357001	17.19	40175025	3.6	4029107100	30.26	41211223	20.5	4123520100	6.9
364358001	17.19	40175026	3.6	4029108100	31.3	41221280	30.12	4123520110	6.9
364364031	17.19	40175049	3.6	40456033	3.8	41225763	2.2	4123520130	6.9
364377001	17.17	40175049	3.8	40456034	3.8	41225764	2.2	4123520140	6.9
364642	20.13	40175050	3.6	40465019	3.8	41225765	2.2	4123520150	6.9
3655400617	30.20	40175050	3.8	40465020	3.8	41225766	2.2	4123520160	6.9
366303	32.2	40175051	3.6	4071300030	6.41	41225767	2.2	4123520170	6.9
36655	29.7	40175052	3.6	4110345010	6.10	41226800	2.2	4123520200	6.10
368851	30.69	40175062	3.8	4110345010	6.48	41226801	2.2	4123520250	6.10
369478	32.2	40175063	3.8	4110345310	6.10	41226802	2.2	4123520250	6.42
3720600220	8.5	40175064	3.6	4111005293	30.71	41226803	2.2	4123520250	6.48
3720600620	8.5	40175064	3.8	4111410000	6.12	41226806	2.2	4123520260	6.9
37225	29.5	40175065	3.6	4111410010	6.12	41226807	2.2	4123520270	6.9
37229	29.5	40175065	3.8	4111410020	6.12	41226810	2.2	4123520300	6.48
372589	16.4	40175072	3.6	4111410020	6.48	41226811	2.2	4123520307	6.48
37322	29.3	40175072	3.8	4111410050	6.12	41226821	2.2	4124420000	6.22
37323	29.2	40175073	3.6	4111410100	6.12	41227562	2.3	4124420000	6.41
37323	29.3	40175073	3.8	4111410100	6.48	41227563	2.3	4124420010	6.22
374338	30.69	4019037	3.9	4111415000	6.12	41227564	2.3	4124-549	2.21
37459	29.2	4019038	3.9	4111415010	6.12	41227565	2.3	4126360000	6.22
37546	29.7	40195011	3.8	4111415030	6.12	41227566	2.2	4126360010	6.22
37547	29.6	40195012	3.8	4111415040	6.12	41227567	2.2	4126360030	6.22
37593	29.8	40195017	3.6	4111428050	6.12	41227568	2.2	4127040000	6.20
37594	29.8	40195018	3.6	4111428160	6.12	41227569	2.2	4127040010	6.21
381.413	3.17	40195021	3.8	4111428180	6.12	41227570	2.2	4127040040	6.21
381.419	3.23	40195022	3.8	4111428190	6.12	41227571	2.2	4127040050	6.21
381.391	3.17	40195037	3.6	4111436020	6.12	41227590	2.2	4127040070	6.20
384970	10.7	40195037	3.8	4111438050	6.12	41227591	2.2	4127040080	6.21
3944080	30.72	40195038	3.6	4111438050	6.48	41227741	30.74	4127040080	6.41
3944123	30.83	40195038	3.8	4111438440	6.12	41227865	2.3	4127040080	6.48
3944124	30.62	40195039	3.6	4111438450	6.12	41227866	2.3	4127040120	6.20
3944592	30.59	40195039	3.8	4111510000	6.10	41229054	2.2	4127040130	6.20
395161	16.3	40195040	3.6	4111510000	6.48	41229055	2.2	4127040140	6.20
3953328	16.3	40195040	3.8	4111510030	6.11	41229058	2.2	4127040140	6.42
395641	30.79	40195045	3.6	4111510040	6.11	41229059	2.2	4127040150	6.20
3962893	30.70	40195045	3.8	4111510040	6.41	41229060	2.3	4127040160	6.20
3962894	30.69	40195045	3.9	4111510040	6.42	41229064	2.3	4127040180	6.20
3963471	30.58	40195046	3.6	4111510090	6.11	41229065	2.3	4127040180	6.48
3963476	30.58	40195046	3.8	4111510090	6.42	41229066	2.2	4127040190	6.20
3963479	30.58	40195046	3.9	4111510090	6.48	41229067	2.2	4127040190	6.42
3963486	30.59	40218801	30.68	4111530000	6.10	41229267	2.2	4127040190	6.48
3964418	20.3	40225003	3.8	4111540000	6.11	41229268	2.2	4127040270	6.20
397946	30.69	40225004	3.8	4111540000	6.48	41229271	2.2	4127040277	6.48
3985226	30.74	40225015	3.6	4111540030	6.11	41229272	2.2	4127049372	6.20
3985651	30.83	40225015	3.8	4111540030	6.48	41231055	2.2	41271148	34.9
3986328	20.13	40225016	3.6	4111540040	6.48	4123520010	6.10	41285356	16.4
3986330	20.14	40225016	3.8	4115530000	6.21	4123520020	6.10	4132549	2.21
3987498	30.59	40225025	3.8	4115530010	6.21	4123520030	6.9	4175037400	25.36

Cross Reference	Page	Cross Reference	Page	Cross Reference	Page	Cross Reference	Page	Cross Reference	Page
42061638	30.11	4231050040	2.5	4231074080	2.5	4235061040	2.7	4253560010	2.16
42063311	16.3	4231050200	2.7	4231074110	2.5	4235061200	2.7	4253620020	2.22
4210050200	24.2	4231050300	2.5	4231074110	2.7	4235061230	2.7	4254510500	2.16
4213500870	10.5	4231050310	2.5	4231090010	2.5	4235061240	2.7	4254510501	2.16
4213520820	10.5	4231050720	2.5	4231090030	2.5	4235061300	2.7	4254520220	2.16
4213559312	21.4	4231050800	2.5	4231090040	2.5	4235061430	2.7	4254520230	2.16
4213659202	10.10	4231050840	2.5	4231090070	2.5	4235090200	2.7	4254521000	2.16
4213659292	30.63	4231050890	2.5	4231090080	2.5	4235100100	2.7	4254521010	2.16
4213559422	10.10	4231050980	2.5	4231090100	2.5	4235100200	2.7	4254521020	2.16
4214100250	24.4	4231051110	2.5	4231090130	2.5	4235100210	2.7	4254521030	2.16
4214100390	24.4	4231051250	2.5	4231090200	2.5	4235110100	2.7	4254521040	2.16
4214100410	24.4	4231051260	2.5	4231090220	2.5	4235110110	2.7	4254521050	2.16
4214100590	24.4	4231051340	2.5	4231091020	2.5	4235120100	2.7	4254530100	2.16
4214110210	24.4	4231051990	2.5	4231091200	2.5	4235140200	2.7	4254530110	2.16
4214110940	24.4	4231052920	2.5	4231099000	2.5	424580	32.3	4254530120	2.16
4214113000	24.4	4231054060	2.5	4231100010	2.5	42498096	20.5	4254530130	2.16
4214113010	24.4	4231054080	2.5	4231107100	2.7	42498432	20.5	4254540500	2.17
4214113060	24.4	4231054090	2.5	4231107110	2.7	42498433	20.5	4254541110	2.16
4214113080	24.4	4231054170	2.5	4231140020	2.5	4253110040	2.19	4254541120	2.16
4214113110	24.4	4231054500	2.5	4231140100	2.5	4253110040	24.6	4254541130	2.16
4214113140	24.4	4231054510	2.5	4231430020	2.17	42531697	20.5	4254563100	2.16
4214113160	24.5	4231057000	2.7	4232051010	2.7	42532300	3.3	4254563110	2.16
4214115000	24.5	4231057040	2.5	4232061010	2.5	42532300	3.8	4254563120	2.16
4214120000	24.5	4231060410	2.5	4235030000	2.7	42532301	3.3	4254563130	2.16
4214290030	24.5	4231060460	2.5	4235030110	2.7	42532301	3.8	4254571000	2.17
4214410030	24.5	4231060580	2.5	4235040020	2.7	42532302	3.3	42545831	20.2
4214420000	24.5	4231060810	2.5	4235040120	2.7	42532302	3.8	42548189	3.3
4214420080	24.5	4231060880	2.5	4235040130	2.7	42532303	3.3	42548190	3.3
4214420180	24.5	4231060950	2.5	4235040140	2.7	42532303	3.8	42554758	3.3
4214450000	24.5	4231060960	2.5	4235040200	2.7	42532304	3.3	42554759	3.3
4220100100	24.5	4231060980	2.5	4235040210	2.7	42532304	3.8	42558437	16.3
4220100120	24.5	4231061060	2.5	4235040240	2.7	42532305	3.3	42559189	3.3
4220100140	24.5	4231061150	2.5	4235041100	2.7	42532305	3.8	42559190	3.3
4228024020	24.5	4231061250	2.5	4235041300	2.7	4253260500	2.17	42559201	3.3
4228140000	24.5	4231061440	2.5	4235050010	2.7	4253260520	2.17	42559201	3.8
4230070190	2.5	4231062010	2.5	4235050020	2.7	4253270540	2.17	42559202	3.3
4230089170	2.5	4231062020	2.5	4235050070	2.7	4253270640	2.17	42559202	3.8
4230690010	2.16	4231062070	2.5	4235060010	2.7	42533002	3.3	42559203	3.3
4230690020	2.16	4231062080	2.5	4235060030	2.7	42533002	3.8	42559204	3.3
4230690050	2.16	4231062920	2.5	4235060200	2.7	42533004	3.3	42559617	3.3
4230700500	2.17	4231062940	2.5	4235060210	2.7	42533004	3.8	42559618	3.3
4230701200	2.17	4231062950	2.5	4235060240	2.7	4253311010	2.17	42560072	3.3
4230720000	2.16	4231064020	2.5	4235060250	2.7	42534117	3.8	42560073	3.3
4230760200	2.16	4231064030	2.5	4235060430	2.7	42534118	3.8	4295536	6.41
4230820100	2.16	4231064080	2.5	4235060500	2.7	42534119	3.8	4324052242	1.12
4231020150	2.5	4231064090	2.5	4235060510	2.7	42534121	3.8	4324062222	1.12
4231040020	2.5	4231064210	2.5	4235060520	2.7	42534122	3.8	4324069202	1.12
4231040040	2.5	4231064230	2.5	4235060530	2.7	4253460020	2.17	4324070120	90.9
4231040100	2.5	4231064300	2.5	4235060550	2.7	4253520000	2.16	4324070150	90.9
4231040930	2.5	4231064500	2.5	4235060600	2.7	4253520010	2.16	4324070170	90.9
4231046060	2.5	4231067000	2.7	4235060720	2.7	4253520500	2.17	4324070180	90.9
4231046080	2.5	4231067010	2.7	4235060810	2.7	4253540000	2.16	4324070500	90.9
4231047000	2.7	4231070080	2.5	4235061000	2.7	4253540010	2.16	4324070600	90.9
4231047100	2.7	4231070980	2.5	4235061010	2.7	4253550100	2.16	4324070700	90.9
4231047110	2.7	4231074060	2.5	4235061020	2.7	4253550110	2.16	4324100000	1.7
4231047120	2.7	4231074070	2.5	4235061030	2.7	4253560000	2.16	4324100050	1.7

CROSS REFERENCES

Manufacturers Part Numbers are for the purpose of reference only.

Cross Reference	Page	Cross Reference	Page	Cross Reference	Page	Cross Reference	Page	Cross Reference	Page
4324100070	1.7	4324102500	1.8	4324251050	34.2	4341001250	22.3	4410140150	30.75
4324100100	1.7	4324102520	1.8	4324301930	1.9	4341001260	22.3	4410140170	30.75
4324100110	1.7	4324107200	1.8	4324301930	90.9	4341001270	22.3	4410140190	30.75
4324100200	1.7	4324107350	1.8	4324310080	1.9	4341001280	22.3	4410140210	30.75
4324100202	1.11	4324109070	1.8	4324310080	1.11	4341001300	22.3	4410140250	30.76
4324100210	1.7	4324109262	1.11	4324310100	1.9	4341001310	22.3	4410140290	30.76
4324100220	1.7	4324109272	1.11	4324310100	1.11	4341001330	22.3	4410141020	30.76
4324100230	1.7	4324109282	1.11	4324330620	1.9	4341001340	22.3	4410141040	30.76
4324100260	1.7	4324111680	1.8	4324330620	1.11	4341001360	22.3	4410146020	30.75
4324100270	1.7	4324150000	1.8	4329012462	1.12	4341001390	22.3	4410320700	30.37
4324100280	1.7	4324150030	1.8	4331500020	10.7	4341001430	22.3	4410320720	30.38
4324100330	1.7	4324150040	1.8	4325110000	1.13	4341001440	22.3	4410320830	30.38
4324100340	1.7	4324150050	1.8	4326862	34.2	4341001530	22.3	4410320920	30.37
4324100370	1.7	4324150060	1.8	4326864	34.2	4341002200	22.3	4410321040	30.38
4324100420	1.7	4324150130	1.8	4329012282	1.11	4341002210	22.3	4410321070	30.36
4324100490	1.7	4324150140	1.8	4329012452	1.11	4341002220	22.3	4410321080	30.35
4324100500	1.7	4324150160	1.8	4331550020	10.8	4341002230	22.3	4410321100	30.33
4324100660	1.7	4324150170	1.8	4331500200	10.8	4341002240	22.3	4410321120	30.47
4324100670	1.7	4324150190	1.8	4333003814	14.17	4341002250	22.3	4410321130	30.47
4324100690	1.7	4324150200	1.8	4333003814	15.11	4341002260	22.3	4410321140	30.39
4324100720	1.7	4324150220	1.8	4333003834	14.17	4341002270	22.3	4410321150	30.36
4324100740	1.7	4324150240	1.8	4333003834	15.11	4341002280	22.3	4410321160	30.36
4324100760	1.7	4324150250	1.8	4333003854	14.17	4341002300	22.3	4410321170	30.36
4324100770	1.7	4324150260	1.8	4333003854	15.11	4341002320	22.3	4410321180	30.38
4324100790	1.7	4324150280	1.8	4333020020	14.16	4341002340	22.3	4410321190	30.36
4324100800	1.7	4324150290	1.8	4333020020	15.11	4341002360	22.3	4410321250	30.41
4324100830	1.7	4324150300	1.8	4333020250	14.16	4341002400	22.3	4410321260	30.41
4324100850	1.7	4324150320	1.8	4334010030	14.16	4341002440	22.3	4410321430	30.41
4324100860	1.7	4324150370	1.8	4334010030	15.11	4341002460	22.3	4410321440	30.41
4324100870	1.7	4324150510	1.8	4334013804	14.17	4341002490	22.3	4410321460	30.41
4324101010	1.7	4324150590	1.8	4334013804	15.11	4341002530	22.3	4410321470	30.41
4324101020	1.7	4324151380	1.8	4340140000	22.5	4341002570	22.3	4410321480	30.41
4324101040	1.7	4324152207	1.11	4340140010	22.5	4341005050	22.3	4410321490	30.41
4324101100	1.7	4324159040	1.8	4341000200	22.2	4341005070	22.3	4410321500	30.41
4324101120	1.7	4324159210	1.8	4341000210	22.2	4341006000	22.3	4410321510	30.41
4324101130	1.7	4324160040	1.8	4341000220	22.2	4342020000	22.4	4410321630	30.47
4324101140	1.7	4324200000	1.9	4341000230	22.2	4342021000	22.4	4410321640	30.47
4324101160	1.7	4324200020	1.9	4341000240	22.2	4342050260	7.5	4410321710	30.37
4324101170	1.7	4324200080	1.9	4341000250	22.2	4342050310	7.5	4410321750	30.42
4324101220	1.7	4324201000	1.9	4341000260	22.2	4342050320	7.5	4410321770	30.40
4324101230	1.7	4324210000	1.9	4341000270	22.2	4342080000	22.4	4410321780	30.40
4324101270	1.7	4324210020	1.9	4341000280	22.2	4342080090	22.4	4410321790	30.40
4324101290	1.7	4324210030	1.9	4341000320	22.2	4342080210	22.4	4410321930	30.43
4324101340	1.7	4324210050	1.9	4341000330	22.2	4342080270	22.4	4410322550	30.44
4324101440	1.7	4324210070	1.9	4341000340	22.2	4342080290	22.4	4410322560	30.14
4324101550	1.7	4324210080	1.9	4341000350	22.2	4342080500	22.4	4410322560	30.44
4324101690	1.7	4324210140	1.9	4341000370	22.2	4342080550	22.4	4410322570	30.45
4324101910	1.7	4324210250	1.9	4341000390	22.2	4343000000	1.13	4410322580	30.44
4324101920	1.7	4324210280	1.9	4341000470	22.2	4345000030	22.5	4410322590	30.44
4324102000	1.7	4324210280	22.5	4341000480	22.2	4346082200	21.3	4410322610	30.44
4324102010	1.8	4324210280	34.2	4341000490	22.2	4346082260	21.3	4410322630	30.14
4324102040	1.8	4324210320	1.9	4341000510	22.2	4346120040	21.3	4410322630	30.44
4324102202	1.11	4324210320	1.13	4341001200	22.3	4347000030	22.6	4410322640	30.14
4324102227	1.11	4324251010	1.9	4341001220	22.3	4410140010	30.75	4410322640	30.44
4324102262	1.11	4324251010	1.13	4341001230	22.3	4410140020	30.75	4410322650	30.44
4324102442	1.11	4324251050	1.9	4341001240	22.3	4410140130	30.75	4410322660	30.45

Cross Reference	Page	Cross Reference	Page	Cross Reference	Page	Cross Reference	Page	Cross Reference	Page
4410322670	30.45	4410324770	30.39	4410329080	30.43	4410350010	30.46	4460040660	17.3
4410322680	30.14	4410325170	30.43	4410329090	30.38	4410351070	30.47	4460040880	17.3
4410322690	30.14	4410325180	30.43	4410329100	30.36	4410351080	30.47	4460043110	17.3
4410322730	30.45	4410325550	30.38	4410329140	30.40	4410351090	30.47	4460043130	17.3
4410322770	30.45	4410325620	30.41	4410329150	30.38	4410351100	30.47	4460043240	17.3
4410322780	30.45	4410325730	30.35	4410329160	30.39	4410351110	30.47	4460044060	17.3
4410322880	30.45	4410325770	30.36	4410329170	30.38	4410351120	30.47	4460044160	17.3
4410322890	30.45	4410325910	30.39	4410329202	30.37	4410351130	30.47	4460044180	17.4
4410322900	30.45	4410325940	30.38	4410329212	30.35	4410351140	30.47	4460046070	17.4
4410322910	30.46	4410326230	30.22	4410329212	30.48	4410351150	30.47	4460560104	13.8
4410322920	30.46	4410326230	30.43	4410329220	30.36	4410351160	30.47	4460561020	13.8
4410322930	30.46	4410326240	30.22	4410329230	30.37	4410351470	30.47	4460561130	13.8
4410322940	30.46	4410326240	30.43	4410329240	30.39	4410353010	30.33	4460561150	13.8
4410322960	30.46	4410326250	30.41	4410329250	30.38	4410353360	30.47	4460561170	13.8
4410322970	30.46	4410326460	30.37	4410329372	30.38	4410353430	30.39	4460561200	13.8
4410322980	30.46	4410326710	30.42	4410329382	30.38	4410353440	30.39	4460561300	13.8
4410322990	30.46	4410327290	30.36	4410329430	30.36	4410353510	30.43	4460561390	13.8
4410323210	30.36	4410327830	30.48	4410329440	30.36	4410359242	30.43	4460563340	13.8
4410323220	30.36	4410327840	30.48	4410329500	30.37	4410400150	30.54	4460910300	7.4
4410323230	30.36	4410327850	30.39	4410329510	30.36	4410441010	30.54	4461080850	17.4
4410323240	30.36	4410327870	30.40	4410329520	30.36	4410441040	30.54	4461089212	17.2
4410323250	30.36	4410327880	30.39	4410329530	30.36	4410441080	30.54	4461089232	17.2
4410323280	30.39	4410328000	30.42	4410329540	30.33	4410441090	30.54	4461901500	30.60
4410323310	30.36	4410328010	30.42	4410329540	30.42	4410442010	30.54	4461901520	30.60
4410323320	30.41	4410328090	30.35	4410329550	30.36	4410442030	30.54	4463003270	90.11
4410323330	30.41	4410328110	30.37	4410329560	30.37	4410500060	14.14	4463003292	17.22
4410323350	30.36	4410328130	30.35	4410329632	30.35	4410500070	14.14	4463003292	90.11
4410323360	30.39	4410328200	30.37	4410329632	30.48	4410500080	14.14	4463004000	90.11
4410323400	30.47	4410328210	30.35	4410329652	30.42	4410500100	14.14	4463004040	90.11
4410323430	30.13	4410328630	30.37	4410329662	30.35	4410500110	14.15	4463004080	90.11
4410323430	30.40	4410328640	30.38	4410329680	30.37	4410500120	14.15	4463004530	90.11
4410323440	30.13	4410328650	30.38	4410329710	30.43	4410500130	14.15	446414	16.4
4410323440	30.40	4410328670	30.37	4410329740	30.33	4410501000	14.15	4471302015	6.37
4410323470	30.37	4410328680	30.38	4410329740	30.42	4410501010	14.15	4471302215	6.37
4410323480	30.37	4410328690	30.38	4410329742	30.37	4410501200	14.15	4471302815	6.38
4410323510	30.36	4410328700	30.36	4410329762	30.35	4410501210	14.15	4471303315	6.37
4410323530	30.39	4410328710	30.36	4410329780	30.37	4410501220	14.15	4491121200	17.23
4410323540	30.39	4410328720	30.39	4410329782	30.38	4410501230	14.15	4491243370	17.23
4410323670	30.33	4410328740	30.36	4410329792	30.40	4410502020	14.15	4491421200	17.23
4410323670	30.42	4410328850	30.38	4410329802	30.38	4410502030	14.15	4491721200	17.23
4410323680	30.33	4410328860	30.38	4410329812	30.38	4410507182	14.16	4491721500	17.24
4410323740	30.33	4410328870	30.38	4410329822	30.38	4410507182	15.11	4491730900	17.24
4410323740	30.42	4410328880	30.40	4410329832	30.37	4411000630	30.60	4491731000	17.24
4410323770	30.40	4410328890	30.39	4410329852	30.39	4411000640	30.60	4491731200	17.24
4410323780	30.40	4410328900	30.36	4410329870	30.39	4411000710	30.60	4491731300	17.24
4410323790	30.40	4410328910	30.42	4410329872	30.39	4411000720	30.60	4491731400	17.24
4410323820	30.35	4410328920	30.42	4410329880	30.39	4411005312	30.71	4491731500	17.24
4410323860	30.37	4410328960	30.39	4410329882	30.38	4420329750	30.43	4492121200	17.24
4410323870	30.37	4410328970	30.39	4410329890	30.41	4422707002	17.26	4492251000	17.24
4410323880	30.37	4410328980	30.39	4410329892	30.36	44540-1290	23.6	4492721200	17.24
4410323890	30.37	4410328990	30.39	4410329902	30.38	4454107464	2.3	4493142570	17.24
4410323960	30.22	4410329020	30.36	4410329912	30.38	4454107764	2.3	4493321200	17.24
4410323970	30.22	4410329030	30.39	4410329930	30.41	4454107964	2.3	4493330030	17.8
4410324010	30.36	4410329040	30.39	4410329932	30.36	4460000009	30.11	4493330030	17.25
4410324100	30.36	4410329060	30.39	4410329950	30.36	4460030780	17.3	4493491000	17.25
4410324760	30.41	4410329070	30.39	4410329952	30.40	4460040650	17.3	4493720300	17.25

CROSS REFERENCES

Manufacturers Part Numbers are for the purpose of reference only.

Cross Reference	Page	Cross Reference	Page	Cross Reference	Page	Cross Reference	Page	Cross Reference	Page
4493720600	17.25	4527110060	90.2	4613152670	9.14	4630131220	10.2	4630909202	26.10
4493743230	17.25	4527110070	90.2	4613154740	9.14	4630131260	10.2	4640023100	14.13
4493861430	17.25	4527110080	90.2	4613154750	9.14	4630131300	10.2	4640023120	14.13
4494021200	17.25	4527110090	90.2	4613154790	9.14	4630132000	10.2	4640023300	14.13
4494440220	17.25	4528020070	90.3	4613154820	9.14	4630132100	10.2	4640023320	14.13
4494441900	17.25	4528030050	90.3	4613154900	9.14	4630220000	26.9	4640023330	14.13
4494442510	17.25	4528040120	90.3	4613154910	9.14	4630220200	26.9	4640023600	14.13
4496120100	17.22	4528050040	90.3	4613154950	9.15	4630220210	26.9	4640025300	14.13
4496120300	17.22	4528060000	90.3	4613154970	9.15	4630281110	10.2	4640025320	14.13
4496141530	17.22	4528080020	90.3	4613170000	9.15	4630320200	26.9	4640027302	14.16
4496142530	17.22	4530040050	90.12	4613170010	9.15	4630320220	26.9	4640027302	15.11
4496150300	17.22	4530040070	90.12	4613170060	9.15	4630320230	26.9	4640040000	14.13
4496161560	17.22	4571320905	6.41	4613180050	9.15	4630320260	26.9	4640050040	14.13
4496162530	17.22	4571305015	6.37	4613180250	9.15	4630321200	26.9	4640060000	14.13
4496172530	17.23	4574600280	20.9	4613180590	9.15	4630321300	26.9	4640060010	14.13
4496172570	17.23	460.806	5.14	4613186030	9.15	4630322200	26.9	4640060020	14.13
4496241130	17.23	460.8067	5.14	4613186050	9.15	4630340050	26.9	4640060110	14.13
4496641900	17.23	460.807	5.14	4613190080	9.15	4630360000	7.4	4640060120	14.13
4496642530	17.23	460.808	5.14	4613190180	9.15	4630360010	7.4	4640061000	14.13
4496720300	17.23	4613074190	9.12	4613190320	9.15	4630360050	7.4	4640062010	14.13
4496720400	17.23	4613074390	9.12	4613190900	9.15	4630360160	7.4	4640067302	14.16
4496720600	17.23	4613074750	9.12	4613192500	9.15	4630360240	7.5	4640067302	15.11
4496720800	17.23	4613074790	9.12	4613192600	9.15	4630370010	7.5	4640070010	14.3
4496843130	17.23	4613150040	9.12	4613192640	9.16	4630370040	7.5	4640070020	14.3
4497120080	30.50	4613150080	9.12	4613192700	9.16	4630370060	7.5	4640070030	14.3
4497120180	30.50	4613150120	9.12	4613192710	9.16	4630460040	10.2	4640070040	14.3
4497120230	30.50	4613150170	9.12	4613192720	9.16	4630490010	10.8	4640070060	14.3
4497120300	30.50	4613150180	9.12	4613192730	9.16	4630490500	10.8	4640070070	14.3
4497120380	30.50	4613150190	9.12	4613192750	9.16	4630550500	10.8	4640070080	14.3
4497120400	30.50	4613150220	9.12	4613192800	9.16	4630550520	10.8	4640070090	14.3
4497120510	30.50	4613150230	9.12	4613197010	9.16	4630620000	10.2	4640070100	14.3
4497120600	30.50	4613150260	9.13	4613197020	9.16	4630630020	10.2	4640070110	14.3
4497120800	30.50	4613150270	9.13	4613240180	9.16	4630630030	10.2	4640070130	14.3
4497121000	30.50	4613150300	9.13	4613245200	9.16	4630740000	26.9	4640070140	14.3
4497121300	17.24	4613150360	9.13	4613280000	9.16	4630790030	90.4	4640070150	14.3
4497230030	30.52	4613150420	9.13	4614911000	9.16	4630840000	26.10	4640070160	14.3
4497230180	30.52	4613150430	9.13	4614911020	9.16	4630840010	26.10	4640070170	14.3
4497230230	17.25	4613150470	9.13	4614940010	9.17	4630840100	26.10	4640070180	14.3
4497230230	30.52	4613150610	9.13	4614940200	9.17	4630840110	26.10	4640070190	14.4
4497230300	17.25	4613150700	9.13	4614940240	9.17	4630840200	26.10	4640070200	14.4
4497230300	30.52	4613150760	9.12	4614941000	9.17	4630840210	26.10	4640070210	14.4
4497230400	30.53	4613150810	9.13	4614941090	9.17	4630840300	26.10	4640070220	14.4
4497230800	17.25	4613150820	9.13	4614941100	9.17	4630840310	26.10	4640070230	14.4
4497230800	30.53	4613150860	9.13	4614945000	9.17	4630840410	26.10	4640070250	14.4
4497231000	30.53	4613151500	9.13	4614945010	9.17	4630841000	26.10	4640078140	14.4
4497520300	17.25	4613151540	9.13	4614945020	9.17	4630850000	10.6	4640080030	14.13
4497560200	30.53	4613151800	9.13	4614945090	9.17	4630850200	10.6	4684020020	15.5
4522000040	90.3	4613152450	9.14	4614945100	9.17	4630850400	10.6	4684020080	15.5
4520021070	90.4	4613152470	9.14	4614945110	9.17	4630900120	26.10	4684042530	15.5
4520021330	90.4	4613152480	9.14	4614945120	9.17	4630900200	26.10	4684060000	15.5
4522000110	90.2	4613152500	9.14	4614990050	9.17	4630900230	26.10	4684060010	15.5
4522000120	90.2	4613152580	9.14	4615130000	17.16	4630903120	26.11	4700120000	9.17
4522002110	90.2	4613152590	9.14	4615130020	17.16	4630903160	26.11	4700125202	16.7
4522002120	90.3	4613152610	9.14	4630131120	10.2	4630905000	26.11	4700150510	27.7
4527110040	90.2	4613152630	9.14	4630131140	10.2	4630905020	26.11	4700150960	27.7
4527110050	90.2	4613152640	9.14	4630131160	10.2	4630905030	26.11	4700152140	27.7

Cross Reference	Page	Cross Reference	Page	Cross Reference	Page	Cross Reference	Page	Cross Reference	Page
4700152550	27.7	4721732260	8.6	4728800620	13.3	4733000130	21.4	4750103170	21.5
4700155510	27.7	4721734280	8.6	4728800650	13.3	4733010000	21.4	4750103180	21.5
4700511020	5.10	4721737000	8.6	4728801000	13.3	4733010010	21.4	4750103220	21.5
4700511040	5.10	4721737010	8.7	4728801030	13.3	4733010030	21.4	4750103240	21.5
4700511080	5.10	4721737040	8.7	4728801040	13.3	4733010130	21.4	4750103250	21.5
4700511090	5.10	4721745970	8.7	4728900220	13.3	4733020000	21.4	4750103280	21.5
4700511140	5.10	4721763160	8.7	4728900500	13.4	4733020010	21.4	4750103300	21.5
4708327	20.5	4721769060	8.7	4729000010	13.4	4733020020	21.4	4750103310	21.5
4710030200	23.9	4721784260	8.7	4729000020	13.4	4735012010	22.9	4750103320	21.5
4710030240	23.9	4721950000	17.7	4729000080	13.4	4735012030	22.9	4750103330	21.5
4710050200	23.9	4721950020	17.7	4729000090	13.4	4750060100	21.4	4750103350	21.5
4710055310	23.9	4721950030	17.7	4729000090	13.7	4750090000	21.4	4750103390	21.5
4712000080	27.7	4721950040	17.7	4729000120	13.4	4750090040	21.4	4750104000	21.5
4712001100	27.7	4721950080	17.7	4729000130	13.4	4750090050	21.4	4750150010	21.5
4714010100	27.7	4721950090	17.7	4729000140	13.4	4750090080	21.4	4750150040	21.5
47160-2452	9.6	4721950100	17.7	4729000210	13.4	4750090220	21.4	4750150050	21.5
47160-3311	9.6	4721950110	17.7	4729000220	13.4	4750090260	21.4	4750150070	21.5
4720023020	8.5	4721950150	17.7	4729000320	13.4	4750100000	21.4	4750150080	21.5
4720174800	8.5	4721950160	17.7	4729000330	13.4	4750100010	21.4	4750150090	21.5
4720174810	8.5	4721950180	17.7	4729000500	13.4	4750100020	21.4	4750150100	21.5
4720706280	8.5	4721950200	17.7	4729000520	13.4	4750100030	21.4	4750150140	21.5
4720706390	8.5	4721950210	17.7	4729000530	13.4	4750100060	21.4	4750150150	21.5
4720726280	8.5	4721950300	17.7	4729000540	13.4	4750100080	21.4	4750150160	21.5
4720726390	8.5	4721950310	17.7	4729000550	13.4	4750100090	21.4	4750150180	21.5
4720901520	8.5	4721950320	17.7	4729000550	13.5	4750100100	21.4	4750150200	21.5
4720902020	8.5	4721950330	17.7	4729000560	13.5	4750100110	21.4	4750150260	21.5
4721231080	8.5	4721950400	17.7	4729000570	13.5	4750100120	21.4	4750150280	21.5
4721271400	8.5	4721950410	17.7	4729000580	13.5	4750100130	21.4	4750150290	21.5
4721289080	8.5	4721950440	17.8	4729000590	13.5	4750100140	21.4	4750150300	21.5
4721300015	6.38	4721950510	17.8	4729000600	13.5	4750100150	21.4	4750150310	21.5
4721300815	6.38	4721950550	17.8	4729000610	13.5	4750100160	21.4	4750150320	21.5
4721301515	6.38	4721950580	17.8	4729000620	13.5	4750100170	21.4	4750150330	21.5
4721331580	8.5	4721950790	17.8	4729000630	13.5	4750100210	21.5	4750150350	21.5
4721700010	8.5	4721950970	17.8	4729000640	13.4	4750100230	21.5	4750150360	21.5
4721706000	8.5	4721951080	17.8	4729000640	13.5	4750100240	21.5	4750150370	21.5
4721706040	8.5	4721959202	17.8	4729000650	13.5	4750100250	21.5	4750150390	21.5
4721706060	8.5	4721959212	17.8	4729000670	13.5	4750100260	21.5	4750150410	21.5
4721706360	8.5	4721959222	17.8	4729000730	13.5	4750100270	21.5	4750150450	21.5
4721710000	8.5	4722500000	8.7	4729000740	13.5	4750100320	21.5	4750150460	21.5
4721713360	8.6	4722500030	8.7	4729001010	13.5	4750102000	21.5	4750150480	21.5
4721717000	8.6	4722500070	8.7	4729001020	13.5	4750102010	21.5	4750150490	21.5
4721717040	8.6	4722600050	8.7	4729001050	13.5	4750103000	21.5	4750150600	21.5
4721717060	8.6	4722600060	8.7	4729001100	13.6	4750103010	21.5	4750150601	21.4
4721717260	8.6	4722600110	8.7	4729001120	13.6	4750103020	21.5	4750150630	21.5
4721720010	8.6	4724000700	8.7	4729001130	13.6	4750103040	21.5	4750150650	21.5
4721726000	8.6	4726000220	8.9	4729001140	13.6	4750103050	21.5	4750150680	21.5
4721726040	8.6	4728800000	13.3	4729051070	13.6	4750103060	21.5	4750150720	21.5
4721726060	8.6	4728800010	13.3	4729051080	13.6	4750103070	21.5	4750150730	21.5
4721726200	8.6	4728800040	13.3	4729051110	13.6	4750103080	21.5	4750153000	21.5
4721726260	8.6	4728800200	13.3	4729051140	13.6	4750103090	21.5	4750154000	21.5
4721726860	8.6	4728800210	13.3	4729051160	13.6	4750103100	21.5	4750155000	21.5
4721727260	8.6	4728800240	13.3	4729051180	13.6	4750103110	21.5	4750155010	21.5
4721727840	8.6	4728800300	13.3	4730110000	23.9	4750103120	21.5	4750155030	21.5
4721727860	8.6	4728800320	13.3	4730170000	23.9	4750103130	21.5	4750155120	21.5
4721729010	8.6	4728800500	13.3	4730170010	23.9	4750103140	21.5	4750180120	21.5
4721732060	8.6	4728800610	13.3	4733000030	21.4	4750103150	21.5	4750190000	23.9

CROSS REFERENCES

Manufacturers Part Numbers are for the purpose of reference only.

Cross Reference	Page	Cross Reference	Page	Cross Reference	Page	Cross Reference	Page	Cross Reference	Page
475111090	15.8	4757100410	15.6	4757110570	15.7	4757137102	14.16	4801020300	17.15
4753042010	11.4	4757100420	15.6	4757110580	15.7	4757137102	15.11	4801020310	17.15
4753042510	11.4	4757100440	15.6	4757110600	15.7	4757145000	15.9	4801020320	17.15
4753042560	11.4	4757101210	15.6	4757110630	15.7	4757145030	15.9	4801020330	17.15
4756040100	26.11	4757101220	15.6	4757110680	15.7	4757145040	15.9	4801020340	17.15
4756040110	26.11	4757101250	15.6	4757110710	15.7	4757145090	15.9	4801020350	17.15
4756040120	26.11	4757101280	15.6	4757110720	15.7	4757145100	15.9	4801020360	17.15
4756040130	26.11	4757101290	15.6	4757110740	15.7	4757145110	15.9	4801020600	17.15
4757001200	15.5	4757101300	15.6	4757110750	15.7	4757146000	15.9	4801020610	17.16
4757001220	15.5	4757101310	15.6	4757110760	15.7	4757155000	15.9	4801020620	17.16
4757001260	15.5	4757101340	15.6	4757110870	15.8	4757155010	15.9	4801020630	17.16
4757002200	15.5	4757101350	15.6	4757110880	15.8	4757155050	15.9	4801020640	17.16
4757004010	15.5	4757101360	15.6	4757110890	15.8	4757155070	15.9	4801020650	17.16
4757004020	15.5	4757101560	15.6	4757110900	15.8	4757155110	15.9	4801020660	17.16
4757004030	15.5	4757110000	15.7	4757110940	15.8	4757155130	15.9	4801020800	17.16
4757004040	15.5	4757110010	15.7	4757110960	15.8	4757155140	15.9	4801030110	17.14
4757004300	15.5	4757110020	15.7	4757110970	15.8	4757200010	15.10	4801030120	17.14
4757010010	15.5	4757110030	15.7	4757110980	15.8	4757200020	15.10	4801030150	17.14
4757010030	15.5	4757110040	15.7	4757110990	15.8	4757200030	15.10	4801030160	17.14
4757010050	15.5	4757110060	15.7	4757111080	15.8	4757200040	15.10	4801030220	17.14
4757010060	15.5	4757110070	15.7	4757111100	15.8	4757200050	15.10	4801030240	17.14
4757010070	15.5	4757110080	15.7	4757111110	15.8	4757200060	15.10	4801030410	17.14
4757010200	15.5	4757110090	15.7	4757111150	15.8	4757205000	15.10	4801030420	17.14
4757010210	15.5	4757110100	15.7	4757111170	15.8	4757210000	15.10	4801030430	17.14
4757017122	14.16	4757110110	15.7	4757111180	15.8	4757210010	15.10	4801030610	17.14
4757017122	15.11	4757110120	15.7	4757111190	15.8	4757210020	15.10	4801030630	17.14
4757020000	15.5	4757110130	15.7	4757111200	15.8	4757210030	15.10	4801040010	17.14
4757020020	15.5	4757110140	15.7	4757111210	15.8	4757210040	15.10	4801040020	17.14
4757020200	15.5	4757110170	15.7	4757111220	15.8	4757210050	15.10	4801040030	17.14
4757020220	15.5	4757110200	15.7	4757111250	15.8	4757210060	15.10	4801040050	17.14
4757100000	15.6	4757110210	15.7	4757111260	15.8	4757210070	15.10	4801040060	17.14
4757100020	15.6	4757110220	15.7	4757111270	15.8	4757210080	15.10	4801040090	17.14
4757100030	15.6	4757110230	15.7	4757111280	15.8	4757210090	15.10	4801041050	17.14
4757100060	15.6	4757110240	15.7	4757111290	15.8	4757210180	15.10	4801041060	17.14
4757100070	15.6	4757110250	15.7	4757111310	15.8	4757210190	15.10	4801041070	17.14
4757100080	15.6	4757110260	15.7	4757111340	15.8	4757215030	15.10	4801050060	17.15
4757100090	15.6	4757110270	15.7	4757111360	15.8	4757220000	15.10	4801050070	17.15
4757100110	15.6	4757110280	15.7	4757111370	15.8	4758003010	15.10	4802020040	23.9
4757100120	15.6	4757110290	15.7	4757111380	15.8	4786919	20.14	4802020050	23.9
4757100130	15.6	4757110300	15.7	4757111420	15.8	4800010000	9.17	4802020090	23.9
4757100140	15.6	4757110310	15.7	4757111430	15.8	4800010050	9.18	4802020120	23.9
4757100160	15.6	4757110320	15.7	4757111450	15.8	4800010100	9.18	4802040010	27.7
4757100200	15.6	4757110330	15.7	4757111460	15.8	4800010110	9.18	4802040030	27.7
4757100210	15.6	4757110340	15.7	4757111480	15.8	4800013000	9.18	4802050010	23.10
4757100220	15.6	4757110360	15.7	4757111490	15.8	4800015000	9.18	4802050100	23.10
4757100240	15.6	4757110370	15.7	4757111500	15.8	4800015202	90.9	4802051030	23.10
4757100250	15.6	4757110380	15.7	4757111540	15.8	4800030000	9.18	4802051040	23.10
4757100280	15.6	4757110390	15.7	4757111550	15.8	4800030040	9.18	4802051060	23.10
4757100290	15.6	4757110400	15.7	4757111590	15.8	4800030390	9.18	4802070010	23.10
4757100310	15.6	4757110410	15.7	4757120000	15.9	4800200100	9.18	4804129	16.5
4757100320	15.6	4757110420	15.7	4757120040	15.9	4800200200	9.18	48100287	14.16
4757100330	15.6	4757110450	15.7	4757127102	14.16	4800200260	9.18	48100287	15.11
4757100350	15.6	4757110460	15.7	4757127102	15.11	4801020100	17.15	482005018000	24.2
4757100360	15.6	4757110510	15.7	4757130000	15.9	4801020140	17.15	4831152	20.5
4757100390	15.6	4757110520	15.7	4757135000	15.9	480102014R	17.15	4833411	20.5
4757100400	15.6	4757110540	15.7	4757135010	15.9	4801020200	17.15	483548	30.30

Cross Reference	Page	Cross Reference	Page	Cross Reference	Page	Cross Reference	Page	Cross Reference	Page
4853408	16.4	4W2130	25.15	4W2655	25.11	4W3300	25.8	5000504322	20.7
4853409	16.3	4W2135	25.15	4W2700	25.14	4W3315	25.26	5000789615	7.2
4896314	20.5	4W2140	25.16	4W2710	25.26	4W3320	25.26	5000790125	30.24
4W1000	25.33	4W2150	25.16	4W2725	25.6	4W3335	25.13	5000792359	16.6
4W1000	25.34	4W2155	25.16	4W2730	25.6	4W3340	25.13	5001454	20.13
4W1005	25.31	4W2160	25.16	4W2735	25.26	4W3400	25.13	5001825536	25.41
4W1010	25.31	4W2170	25.8	4W2740	25.26	4W3425	25.6	5001834842	16.6
4W1015	25.37	4W2210	25.25	4W2745	25.9	4W3430	25.6	5001843522	1.11
4W1020	25.32	4W2215	25.25	4W2750	25.16	4W3460	25.8	5001844056	7.4
4W1025	25.33	4W2220	25.25	4W2755	25.17	4W3480	25.17	5001848402	2.20
4W1025	25.37	4W2230	25.21	4W2760	25.6	4W3485	25.23	5001848403	2.20
4W1030	25.34	4W2235	25.8	4W2775	25.28	4W3490	25.23	5001860203	2.20
4W1035	25.34	4W2240	25.21	4W2780	25.28	4W3495	25.9	5001862853	2.20
4W1040	25.34	4W2250	25.25	4W2785	25.30	4W3520	25.26	5001865386	20.10
4W1046	25.31	4W2260	25.25	4W2790	25.30	4W3525	25.27	5001865396	20.10
4W1055	25.33	4W2265	25.25	4W2795	25.21	4W3550	25.27	5001868113	25.40
4W1065	25.33	4W2270	25.25	4W2800	25.21	4W3555	25.27	5001870062	5.19
4W1075	25.35	4W2275	25.28	4W2815	25.21	4W3575	25.10	5001870063	5.19
4W1080	25.35	4W2280	25.28	4W2820	25.22	4W3645	25.9	50019	30.30
4W1085	25.33	4W2285	25.28	4W2905	25.22	4W3655	25.7	5001933	20.13
4W1090	25.33	4W2290	25.28	4W2910	25.22	4W3660	25.7	5001934	20.13
4W1110	25.35	4W2295	25.28	4W2920	25.22	4W3665	25.7	5001935	20.13
4W1115	25.35	4W2300	25.29	4W2925	25.22	4W3680	25.10	5001938	20.13
4W1120	25.35	4W2305	25.5	4W2930	25.17	4W3685	25.10	5002281	20.13
4W1125	25.31	4W2310	25.14	4W2940	25.22	4W3700	25.7	5003175	20.13
4W1130	25.35	4W2355	25.11	4W2945	25.22	4W3705	25.7	500327378	20.5
4W1135	25.35	4W2360	25.25	4W2955	25.20	4W3710	25.29	500342090	30.12
4W1160	25.35	4W2365	25.11	4W2975	25.10	4W3755	25.24	5006010272	30.11
4W1270	25.32	4W2390	25.11	4W3000	25.6	4W3790	25.7	5006015612	30.12
4W1315	25.33	4W2400	25.5	4W3005	25.6	4W3795	25.17	500789615	7.2
4W1330	25.35	4W2405	25.9	4W3030	25.28	4W3800	25.18	5007933	20.13
4W1335	25.36	4W2410	25.9	4W3035	25.28	4W3805	25.29	5007934	20.13
4W2010	25.4	4W2415	25.9	4W3040	25.22	4W3810	25.30	5007935	20.13
4W2015	25.4	4W2420	25.16	4W3045	25.22	4W3815	25.18	5007938	20.13
4W2020	25.4	4W2425	25.5	4W3050	25.23	4W3820	25.18	5007939	20.13
4W2025	25.4	4W2440	25.16	4W3055	25.23	4W3825	25.24	5008280	20.13
4W2030	25.4	4W2475	25.11	4W3115	25.13	4W3830	25.24	5009175	20.13
4W2035	25.5	4W2480	25.11	4W3120	25.13	4W3840	25.24	5010135073	30.79
4W2040	25.15	4W2505	25.20	4W3125	25.17	4W3845	25.24	5010136472	16.3
4W2045	25.15	4W2510	25.20	4W3130	25.17	4W3890	25.18	5010143017	30.24
4W2050	25.15	4W2515	25.6	4W3135	25.29	4W3895	25.18	5010143018	30.24
4W2055	25.15	4W2540	25.29	4W3140	25.29	4W3900	25.10	5010143019	30.24
4W2060	25.15	4W2545	25.29	4W3145	25.17	4W3910	25.30	5010143020	30.24
4W2065	25.15	4W2575	25.29	4W3150	25.17	4W3915	25.30	5010143029	30.25
4W2070	25.12	4W2580	25.29	4W3155	25.17	4W4010	25.18	5010143030	30.25
4W2075	25.12	4W2585	25.26	4W3165	25.13	4W4015	25.18	5010143084	30.54
4W2080	25.12	4W2590	25.26	4W3170	25.14	4W4135	25.8	5010251357	16.6
4W2085	25.10	4W2595	25.26	4W3195	25.23	4W4170	25.18	5010260052	16.7
4W2090	25.12	4W2610	25.12	4W3200	25.23	4W4200	25.24	5010306719	30.71
4W2095	25.12	4W2615	25.12	4W3205	25.23	4W4215	25.8	5010311242	30.68
4W2100	25.15	4W2620	25.12	4W3210	25.29	4W4305	25.7	5010311958	30.66
4W2105	25.5	4W2625	25.12	4W3255	25.10	4W4315	25.27	5010311958	30.68
4W2110	25.5	4W2630	25.21	4W3260	25.10	4W4320	25.27	501031989	31.6
4W2115	25.5	4W2635	25.21	4W3265	25.13	4W4420	25.18	5010344160	30.24
4W2120	25.5	4W2640	25.21	4W3270	25.13	4W4460	25.24	5010344161	30.24
4W2125	25.5	4W2645	25.21	4W3295	25.30	4W4465	25.24	5010344187	30.25

CROSS REFERENCES

Manufacturers Part Numbers are for the purpose of reference only.

Cross Reference	Page	Cross Reference	Page	Cross Reference	Page	Cross Reference	Page	Cross Reference	Page
5010344188	30.25	5049001675AM	5.19	51540007064	6.33	542002210	20.6	5801291815	30.80
5010360034	8.4	5049001676AM	5.19	51540007064	6.47	542002310	20.6	5801363754	34.3
5010360036	8.4	5049001683AM	5.19	51540007073	6.33	542003110	20.7	5801363754	34.4
5010360058	30.66	5049001684AM	5.19	51540007074	6.35	542003210	20.7	5801424181	34.3
5010398062	30.68	5049001699AM	5.19	51540007074	6.47	542003710	20.12	5801443021	34.3
5010404132	2.20	5049001703AM	5.19	51540007075	6.33	542003810	20.9	5801754014	34.3
5010412449	30.62	5049001704AM	5.19	51540007079	6.33	542004710	20.7	5801754015	34.3
5010422332	30.23	5049001707AM	5.19	51540007082	6.33	542004810	20.7	5801754016	34.3
5010422334	30.23	5049001708AM	5.19	51540007086	6.33	542004910	20.9	5801777219	34.3
5010437049	30.68	5049001719AM	5.19	51540007109	6.33	542005010	20.7	6.00887.000	90.7
5010437653	30.54	5049001720AM	5.19	51540007121	6.33	5420050100	20.8	6.00943.000	90.7
5010450894	30.54	5049001730AM	5.19	51540007129	6.33	542005110	20.7	601002001	15.3
5010457045	30.24	5115408.0016	34.4	51540007131	6.33	542005910	20.6	601002021	15.3
5010457732	30.23	5115408.0017	34.3	51540007135	6.33	542006710	20.6	601013001	15.3
5010457871	30.25	5115408.0017	34.4	51540007178	6.36	542009210	20.9	601013011	15.3
5010457874	30.24	5115408.0018	34.4	51541006001	6.33	542042510	20.12	602005001	15.3
5010457876	30.25	51.27421.000	30.67	51541006003	6.36	542042610	20.12	6028036	16.3
5010457878	30.25	51.27421.0078	30.81	51541006005	6.37	542043310	20.4	612025001	14.16
5010457881	30.25	51.27421.0172	30.81	51541006007	6.36	5420433H1	20.4	612025001	15.11
5010457883	30.25	51.27421.0216	30.56	51541006007	6.47	542043410	20.12	612032001	14.6
5010457892	30.25	51.27421.0233	30.63	51541006009	6.36	542043910	20.6	612035011	14.6
5010477145	30.65	51.27421.0263	30.67	51541006011	6.37	542044310	20.10	612035021	14.6
5010514270	30.65	510260645	2.20	51541006013	6.37	542045310	20.7	612035031	14.6
5010525491	2.20	510260647	2.20	51541006015	6.37	542045310	20.8	612035041	14.6
5010525492	2.20	5106153333	20.4	51541006015	6.47	542045410	20.9	612035051	14.6
5010525493	2.20	51094136000	30.55	51541007003	6.37	5429018	30.60	612035071	14.6
5010525494	2.20	51154080004	34.3	51541007010	6.36	5430000717	5.14	612046211	14.6
501058325	8.4	51154080004	34.4	51541007025	6.37	545635	30.69	612046261	14.6
5010600046	20.10	51154080009	34.3	51541007028	6.36	54997	7.2	612047002	14.6
5010600054	20.10	51154080009	34.4	51541007033	6.36	554005001	7.5	612048111	14.6
5010604322	30.23	51154080015	34.3	51541007033	6.47	5631129130	7.4	612048131	14.6
501073323	30.54	51154080015	34.4	51541007066	6.36	5634411100	7.2	612048171	14.7
5021170122	30.23	51154080016	34.4	51541007178	6.47	5634461000	7.5	612056021	14.7
5021170123	30.23	51154080017	34.4	51541007179	6.37	5710020000	7.5	612057001	14.7
503128324	2.20	51154080018	34.4	51541007249	6.37	5710030020	7.5	613005001	15.3
504007426	30.12	51154080019	34.3	51542100108	6.41	5710031040	7.5	61530728	30.75
504013848	30.11	51154080019	34.4	516563	30.79	5710039200	7.5	620056	29.8
504049819	30.54	51259020123	8.3	530705	30.29	5710040000	7.5	6205420217	30.20
504078368	20.5	51259020130	8.3	533633	30.59	5710400000	7.5	6205420517	30.20
504095152	30.80	51271200008	30.61	5340170090	22.5	571297	20.11	622070	5.9
504102603ZE	30.80	51271200009	30.61	535520	30.56	571365	20.11	622080	5.9
504140125	20.5	51271200014	30.61	541033011	24.3	571366	20.11	622107	5.8
50420003H1	20.11	51271200015	30.61	5411300108	6.39	571369	20.11	622108	5.8
50420007H1	20.12	51271207037	30.61	5411303619	6.39	571370	20.11	622109	5.8
50420032H1	20.7	51271207038	30.61	542000110	20.12	571382	20.11	622190	5.8
50420434H1	20.12	51274210102	30.55	542000310	20.11	571390	20.11	622199	5.8
504234189	3.8	51274210132	30.80	542000310	20.12	571393	20.11	622206	5.6
504234190	3.8	51274210173	30.55	542000410	20.11	571393	20.12	622402	5.6
504365576	34.7	51274210181	30.55	542000710	20.12	571434	20.11	622500	5.4
504365576	34.9	51540007027	6.33	542000810	20.11	571436	20.11	622501	5.4
504374327	34.7	51540007055	6.33	542001010	20.11	5717400000	7.2	622508	5.5
504374327	34.9	51540007057	6.33	542001210	20.11	574929	5.17	623104AM	16.6
5049001667AM	5.19	51540007058	6.34	542001310	20.11	574944	5.17	623105AM	16.6
5049001668AM	5.19	51540007058	6.47	542001410	20.3	580086C	8.2	623106AM	16.6
5049001671AM	5.19	51540007059	6.33	542001710	20.3	5801115879	30.11	623109AM	16.6
5049001672AM	5.19	51540007063	6.33	542001810	20.12	5801273980	34.3	623160AM	16.6

Cross Reference	Page	Cross Reference	Page	Cross Reference	Page	Cross Reference	Page	Cross Reference	Page
624199	5.8	626853	5.7	629582	5.16	68033182NZP	2.20	70867C	25.16
624248AM	16.6	626869	5.5	629614	5.18	68191510	25.40	70870	25.18
6243560080	32.2	626871	5.4	629683	5.8	68191511	25.40	70893	25.14
624445	5.7	627111	5.17	629862	5.16	68192115	25.40	70894	25.14
624502AM	16.6	627111	30.55	629920AM	5.18	68192410	25.40	70903C	25.9
624503AM	16.6	627208	5.9	629978	5.16	682961	32.2	70931	25.14
624652	5.6	627233AM	16.7	630361AM	5.6	68323934	2.20	70943C	25.11
624702	20.3	627494	5.17	630388	5.16	68324692	2.20	70944C	25.11
625067	5.4	627496	5.16	630388	5.17	68325486	2.2	70949C	25.35
625111	5.5	627497	5.6	630424AM	5.7	68325960	2.3	70952	25.15
625290	5.6	627498AM	5.6	630767	5.16	68325961	2.3	70953	25.15
625290	5.7	627499	5.6	630767	5.17	6857432	16.3	70954C	25.15
625359	5.8	627579	5.5	630767	30.54	6879899	20.13	71034	1.10
625375	5.7	627589	5.5	630889AM	5.9	69294	32.2	71059	1.10
625385	5.6	627612	5.7	631355AM	5.18	69502946	30.80	71200	1.3
625436AM	5.6	627667	5.4	631522AM	16.7	696925	25.40	71201	1.3
625524	5.6	627668	5.5	6401950710	3.9	6Y1505	25.34	71202	1.3
625536AM	16.6	627669	5.4	6401950720	3.9	6Y1510	25.32	71203	1.3
6255420018	30.21	627692	5.8	6401950850	3.9	6Y1515	25.36	71206	1.3
625559AM	5.6	627803	5.9	6401950860	3.9	6Y1520	25.37	71208	1.3
625586	5.6	627804	5.9	640225015R	3.6	6Y1525	25.37	71209	1.3
625671	5.5	627805	5.9	640225016R	3.6	6Y1535	25.36	71215	1.3
625810	5.5	627946	5.8	6402250220	3.6	6Y1550	25.32	71216	1.3
625826AM	16.6	628027	5.6	6402250230	3.6	6Y1560	25.34	71230	1.2
625942	5.18	628036	5.3	6402250400	3.6	6Y1565	25.34	71239	1.2
626104	5.6	628045	5.9	6402250400	3.9	6Y1580	25.32	71240	1.2
626119	5.9	628258	5.4	6402250410	3.6	6Y6500	25.19	7166885	31.4
626156	5.18	628259	5.5	6402250410	3.9	6Y6505	25.19	7172753	31.4
626159AM	16.6	628260	5.4	6403220310	3.8	6Y6510	25.19	7172934	31.4
626162	5.6	628275	5.5	6403220320	3.8	6Y6515	25.19	72007	25.35
626261	5.16	628276	5.4	6403220340	3.8	6Y6520	25.19	72008	25.35
626321	5.16	628276	5.7	6403220350	3.8	6Y6525	25.19	720102	29.9
626392	5.9	628277	5.4	6403220980	3.9	6Y6540	25.19	72014	25.10
626397	5.5	628277	5.7	6403220990	3.9	6Y6545	25.19	72015	25.10
626397	5.6	628446	5.4	6409157424	3.9	6Y6600	25.7	720322	29.9
626400	5.5	628448	5.5	6409157434	3.9	6Y6620	25.14	72036	25.15
626448	5.18	628449	5.5	642.01608	5.15	6Y6625	25.13	72037	25.16
626453AM	5.17	628450	5.5	642.03080	5.15	6Y6630	25.14	72038	25.16
626564AM	16.6	628492	5.9	642.03105	5.15	6Y6660	25.14	72039	25.17
626565AM	16.6	628493	5.9	642.03502	5.15	6Y6720	25.14	72040	25.17
626580	5.5	628494	5.9	64225252	25.40	6Y6725	25.14	72041	25.17
626597	5.17	628554	5.8	6503560080	32.2	6Y6730	25.14	72053C	25.31
626639	5.9	629134	5.5	6505400117	30.22	700120000	9.17	72054	25.17
626642	5.4	629135	5.5	6505400217	30.22	7018955153	20.3	72055	25.18
626661	5.16	629137AM	5.18	654466X	2.20	70351557	30.33	72059	25.15
626662	5.16	629184AM	5.7	6555400717	30.22	70351745	30.70	72060	25.18
626664	5.17	629218	5.17	6555400817	30.22	70511	25.11	72061	25.18
626693	5.5	629218AM	5.18	657082-7	30.9	70512	25.11	72064	25.18
626708	5.4	629219	5.18	65730431	30.9	70582C	25.11	72065	25.18
626760AM	16.6	629276	5.9	65868530	30.9	70583C	25.11	72173	25.16
626761AM	16.6	629277	5.9	6672900212	16.2	70706C	25.16	72174	25.16
626762AM	16.6	629300	5.7	6683560515	31.4	70771	25.17	72178	25.17
626783	5.5	629303AM	5.18	6732950006	16.2	70772	25.17	72180	25.8
626784	5.5	629479	5.5	6771722	16.3	70775C	25.15	72181	25.8
626785	5.4	629479	5.6	6795109	20.12	70802	25.35	72203	25.20
626786	5.4	629479AM	5.5	6796031	30.59	70803	25.35	72204	25.20

CROSS REFERENCES

Manufacturers Part Numbers are for the purpose of reference only.

Cross Reference	Page	Cross Reference	Page	Cross Reference	Page	Cross Reference	Page	Cross Reference	Page
72211C	25.16	72705	25.7	7420870050	30.72	7673955534	20.7	7685955180	20.6
72212C	25.16	72717	25.29	7420875073	30.72	7673955545	20.9	7685955181	20.6
72213	25.15	72718	25.29	7420898038	30.70	7673955554	20.7	7685955184	20.6
72238	25.35	72720C	25.29	7420915970	30.24	7673955572	20.5	7685955247	20.8
72239	25.35	72721	25.29	7420915973	30.24	7673955580	20.5	7685955249	20.10
72249	25.25	72722	25.30	7420916171	30.25	7673955702	20.5	7685955251	20.9
72250C	25.35	72723	25.28	7420916173	30.25	7673955816	20.15	7685955331	20.4
72254C	25.37	72724	25.28	7420916175	30.23	7673955908	20.8	7685955347	20.6
72256	25.33	72725	25.29	7420916178	30.24	7673955913	20.8	7685955628	20.14
72261	25.33	72726	25.28	7420981961	30.66	7673955963	20.13	7685955787	20.12
72262	25.25	72727	25.26	7421017710	20.3	7673955963	20.14	7685955791	20.13
72263	25.25	72728	25.26	7421017710	20.13	7674955207	20.3	7685955791	20.14
72264	25.25	72729	25.26	7421164790	30.85	7674955217	20.11	7685955908	20.9
7235390008	12.5	72730	25.27	7421225020	30.85	7674955232	20.5	7685955956	20.12
72459	25.28	72744C	25.25	7421234246	34.7	7674955245	20.6	7685974704	20.14
72460	25.28	72745C	25.25	7421234246	34.9	7674955247	20.13	7686955113	20.6
72461	25.28	72758C	25.10	7421302639	30.70	7674955284	20.11	7686955729	20.13
72462	25.28	72782	25.28	7421318366	10.3	7674955306	20.5	7686955729	20.14
72523	25.4	72783	25.29	7421360516	30.25	7674955519	20.6	7686.955.174	20.10
72524	25.4	72784	25.29	7421363479	30.25	7674975960	20.15	7687955123	20.6
72525	25.5	72785	25.29	7421363496	30.23	7677955106	20.11	7688955505	20.5
72526	25.5	72788	25.33	7421364022	30.25	7677955107	20.11	7692900510	20.9
72532	25.7	72788	25.34	7421789078	20.10	7677955108	20.11	7692900510	20.10
72534	25.4	72809	25.17	7422219284	34.5	7677955110	20.11	770074316	32.2
72535	25.6	72810	25.17	7422219284	34.6	7677955116	20.11	7700743161	32.3
72536	25.5	72811	25.18	7422827995	34.5	7677955129	20.12	7700854841	32.2
72537	25.5	72812	25.18	7422827995	34.6	7677955163	20.7	7700854841	32.3
72538	25.4	72815	25.6	7422219284	34.5	7677955163	20.9	77430	1.10
72539	25.4	72816	25.6	7422219284	34.7	7677955201	20.7	778807500	30.31
72540C	25.5	72825	25.25	7422827995	34.5	7677955201	20.9	77880750340	30.12
72542	25.5	72826	25.26	7422827995	34.7	7683955126	20.5	7788090000	30.9
72543	25.5	72875	25.31	7424427344	30.24	7684900111	20.4	78010	25.9
72544	25.7	72876	25.31	758188.01SP	16.2	7684955139	20.9	78104S	1.3
72545	25.7	72886	25.6	758188.01SP	16.5	7684955148	20.6	78127	1.2
72547	25.7	72887	25.6	76046	25.41	7684955189	20.7	78165	1.16
72568C	25.8	72928C	25.20	7672955253	20.5	7684955190	20.7	78217	1.2
72591C	25.10	72929C	25.9	7672955287	20.3	7684955190	20.8	78219	1.2
72592C	25.10	72930C	25.9	7673955110	20.12	7684955198	20.7	78650	1.2
72593	25.15	72939	25.8	7673955116	20.7	7684955763	20.13	78682	1.2
72594	25.15	72948	25.34	7673955125	20.8	7684955903	20.8	78703S	1.3
72596	25.16	72954	25.26	7673955127	20.7	7684955911	20.8	78717S	1.3
72608	25.5	72955C	25.26	7673955139	20.13	7684955913	20.8	78949S	1.3
72609	25.5	72967	25.13	7673955190	20.14	7684955915	20.10	78964	1.10
72641	25.30	72978	25.13	7673955202	20.13	7684955921	20.7	78984	1.2
72654	25.26	72979	25.13	7673955209	20.13	7684955955	20.10	78985	1.2
72660	25.25	730111000	23.10	7673955211	20.13	7684974704	20.13	78986	1.2
72661	25.25	73025	25.6	7673955213	20.13	7685900103	20.5	78988	1.2
72662	25.25	7420513340	30.71	7673955217	20.3	7685900104	20.4	78990	1.2
72662C	25.25	7420528661	30.24	7673955219	20.13	7685955102	20.6	79004	25.33
72670	25.29	7420726986	30.51	7673955225	20.13	7685955104	20.3	79004	25.37
72671	25.29	7420766868	34.7	7673955243	20.13	7685955134	20.7	79005	25.34
72678	25.28	7420766868	34.9	7673955294	20.5	7685955149	20.8	79007	25.21
72679	25.7	7420785816	30.25	7673955294	20.6	7685955152	20.6	79008	25.22
72688	25.30	7420787816	30.25	7673955311	20.5	7685955153	20.6	79009	25.24
72689	25.30	7420794630	30.24	7673955322	20.5	7685955154	20.6	79010	25.24
72704	25.7	7420796740	30.70	7673955395	20.14	7685955164	20.9	79011	25.23

Cross Reference	Page	Cross Reference	Page	Cross Reference	Page	Cross Reference	Page	Cross Reference	Page
79013	25.21	79302	25.22	8001902	20.7	81.32688.6009	8.3	81271206117	30.13
79014	25.21	79304	25.23	80020	25.34	8112286	20.12	81271206119	30.15
79017	25.21	79305	25.23	80021D	25.32	8112342	20.12	81271206120	30.15
79018	25.21	79306	25.24	80022D	25.36	8112593	20.12	81271206121	30.14
79020C	25.23	79307	25.24	80022S	25.35	8112963	20.12	81271206122	30.14
79021C	25.23	79308	25.23	80022S	25.36	8113174	20.13	81271206123	30.17
79022	25.32	79309	25.23	80023D	25.37	8113268	20.12	81271206124	30.17
79023D	25.37	79310	25.22	80023S	25.37	8113282	20.12	81271206125	30.17
79023S	25.37	79311	25.22	80024	25.37	8113432	20.12	81271206126	30.17
79024	25.6	79347C	25.27	80030C	25.19	8113461	20.12	81271206131	30.18
79033	25.26	79348C	25.27	80041	25.36	8113586	20.12	81271206146	30.16
79034	25.26	79396C	25.27	80108	25.32	8118286	20.12	81271206147	30.16
79035	25.34	79397C	25.27	80124C	25.34	8118593	20.12	81271206149	30.17
79040C	25.10	79407	25.28	80125C	25.34	8119174	20.13	81271206151	30.17
79041C	25.10	79407C	25.27	80133C	25.7	8119268	20.12	81271206154	30.18
79043C	25.35	79408C	25.27	80134C	25.32	8119432	20.12	81271206156	30.16
79044C	25.36	79440	25.24	8017112	2.23	8119461	20.12	81271206157	30.17
79097	25.33	79441	25.24	8017114	2.23	8119586	20.12	81271206160	30.19
79098	25.33	79442C	25.26	8017116	2.23	81225200079	30.55	81271206164	30.19
79105	25.27	79443C	25.26	8017120	2.23	81225200171	30.76	81271206165	30.19
79106	25.27	79504C	25.33	8017130	2.23	81225200184	30.76	81271206166	30.18
79133C	25.8	79637C	25.18	8017136	2.23	81255140032	30.67	81271206167	30.18
79138C	25.32	79638C	25.18	8017209	2.23	81255140210	30.67	81271206168	30.17
79139C	25.32	79641C	25.30	8017212	2.23	81255146004	30.67	81271206169	30.17
79149	25.32	79642C	25.30	8017214	2.23	81255200010	30.59	81271206170	30.17
79150	25.23	79677	25.30	8017216	2.23	81255200021	30.59	81271206171	30.17
79151	25.23	79678	25.30	8017220	2.23	81255200055	30.77	81271206174	30.16
79160	25.33	79682	25.8	8017227	2.23	81255200076	30.77	81271206176	30.18
79177	25.20	79683C	25.24	8017241	2.23	81255200100	30.77	81271206177	30.18
79183C	25.33	79684C	25.24	8017316	2.23	81255200117	30.76	81271206178	30.16
79186	25.18	79792C	25.36	8017320	2.23	81255200152	30.77	81271206179	30.16
79205	25.12	79793C	25.36	8017424	2.23	81255200161	30.60	81271206182	30.15
79206	25.12	80000C	25.19	8017430	2.23	81255200163	30.77	81271206183	30.15
79207C	25.13	80001C	25.19	80176	25.14	81255200167	30.77	81271206184	30.15
79208	25.12	80008C	25.19	80177	25.14	81255200190	30.78	81271206185	30.15
79209	25.12	80009C	25.19	80178	25.14	81255200196	30.76	81271206186	30.14
79210	25.12	80010C	25.19	80179	25.14	81255200204	30.76	81271206187	30.14
79211	25.12	80011C	25.19	80180	25.14	81255200210	30.77	81271206188	30.15
79212	25.12	8001449	20.3	80181	25.14	81255206006	30.59	81271206189	30.15
79216C	25.13	8001453	20.13	80183	25.13	81259090009	30.79	81271206190	30.13
79219	25.13	8001455	20.3	80295	25.36	81259090036	30.79	81271206191	30.13
79220	25.13	8001456	20.13	80455700	3A.3	81271206006	30.17	81271206192	30.15
79223	25.12	8001457	20.13	81.25429.6893	30.52	81271206007	30.16	81271206193	30.14
79224	25.12	8001458	20.13	81.25429.6894	30.53	81271206017	30.16	81271206194	30.14
79225	25.13	8001461	20.5	81.25503.0244	30.78	81271206018	30.17	81271206200	30.16
79226	25.13	8001468	20.3	81.27120.6161	30.19	81271206040	30.17	81271206201	30.18
79227	25.13	8001469	20.5	81.27120.6175	30.19	81271206045	30.16	81271206202	30.18
79229C	25.21	8001472	20.13	81.27421.0151	30.56	81271206046	30.17	81271206203	30.15
79288	25.22	80014C	25.19	81.27421.0232	30.64	81271206067	30.16	81271206204	30.15
79289	25.22	8001511	20.7	81.27421.0265	30.81	81271206068	30.17	81271206218	30.13
79294	25.22	8001514	20.13	81.27421.6047	30.56	81271206072	30.18	81271206219	30.13
79295	25.22	8001860	20.3	81.32550.6016	10.3	81271206073	30.19	81271206220	30.16
79296	25.21	8001872	20.13	81.32620.0091	10.6	81271206077	30.17	81271206221	30.16
79297	25.21	8001873	20.5	81.32620.0095	10.6	81271206097	30.18	81271206224	30.16
79300	25.21	8001883	20.13	81.32655-6311	5.19	81271206105	30.13	81271206225	30.16
79301	25.22	80019	25.31	81.32655-6322	5.19	81271206106	30.13	81271206228	30.16

CROSS REFERENCES

Manufacturers Part Numbers are for the purpose of reference only.

Cross Reference	Page	Cross Reference	Page	Cross Reference	Page	Cross Reference	Page	Cross Reference	Page
81271206229	30.16	814036001	17.18	81965030398	31.4	87189	1.2	90554114	14.7
81271296039	30.16	814036001	90.10	8196503600	31.4	87282	1.2	90554147	14.7
81274210080	30.79	814036011	17.18	81970106009	10.6	87296	1.2	90554183	14.7
81274210097	30.67	814036011	90.10	81970106010	10.6	87332S	1.3	90554243	14.7
81274210098	30.67	814036021	17.18	81970106011	10.6	87346S	1.3	90554273	14.7
81274210109	30.67	814036021	90.10	81970106013	10.7	87347S	1.3	90554614	22.6
81274210125	30.80	814037001	17.18	820007001	17.13	87348S	1.3	90554615	22.6
81274210135	30.79	8141475	30.63	820008001	17.13	8840104090	30.44	90554648	14.7
81274210152	30.64	8144352	14.14	820019001	17.13	8840110840	14.15	90554663	14.2
81274210163	30.77	81471016013	20.6	820026001	17.13	8840166580	30.37	9061320305	6.41
81274210169	30.64	81471016031	20.6	8282211000	16.4	8840168930	30.47	9110047250	6.11
81274210184	30.67	81471016039	20.6	83377	1.3	8840168940	30.47	9110048960	6.11
81274210184	30.77	81471016082	20.6	83378	1.3	8848303170	30.41	9111450500	6.12
81274210202	30.54	81471016086	20.6	83379	1.3	89199302874	30.9	9111450600	6.12
81274210230	30.67	81471016090	20.6	85000031	20.13	89419513	30.11	9111450600	6.41
81274210237	30.81	81471016103	20.6	85000047	20.12	8946010112	17.25	9111455000	6.12
81274210242	30.81	81471016116	20.6	85000094	20.13	8946010142	17.25	9111455600	6.12
81274210251	30.67	81471016122	20.6	85000096	20.13	8946011322	17.9	9111455600	6.41
81274210253	30.81	81471016136	20.6	85000180	20.13	8946011322	23.16	9111530010	6.11
81274210262	30.67	81471016137	20.6	85000256	20.13	8946011322	30.51	9111535100	6.11
81274210263	30.81	81471016140	20.6	85000770	20.13	8946011362	17.9	9111535200	6.11
81274210264	30.81	81471016162	20.6	85000770	20.14	8946011382	30.51	9111535300	6.11
81274211040	30.79	81471016181	20.6	85000972	20.13	8946011392	30.51	9111535330	6.11
81274216043	30.67	81471016186	20.6	85000973	20.13	8946011612	13.9	9111535400	6.11
81274216048	30.67	81471016189	20.6	85000974	20.13	8946011612	17.8	9111539202	6.11
81307156051	16.4	81471016219	20.6	85000974	20.14	894880	16.4	9111539350	6.11
81307156119	16.3	81471019082	20.6	85006096	20.13	8971204954	2.23	9111539360	6.11
81307156119	16.6	81471019103	20.6	85103704	20.13	8971205054	2.23	9111545130	6.12
81307156120	16.6	8147101916	20.6	85103705	20.13	8971205104	2.23	9111545150	6.12
81307156132	16.3	81471019189	20.6	85103705	20.14	8971205154	2.23	9111545160	6.12
81307156135	16.3	8147106122	20.6	85103778	20.3	8971205164	2.23	9111555140	6.23
81307156140	16.2	8148465	20.3	85104850	22.4	8971205204	2.23	9115010100	6.23
81307156141	16.2	8148567	20.3	85109590	30.74	8971205254	2.23	9115010110	6.23
81307166020	16.4	815015001	90.10	85114316	20.13	8971205264	2.23	9115010160	6.23
81307166082	16.4	815018001	90.11	85114317	20.13	8971205354	2.23	9115010550	6.23
81326200043	10.6	815041001	90.11	85114317	20.14	8971205364	2.23	9115010560	6.23
81326200044	10.6	8150500	30.84	85114318	20.13	8971205404	2.23	9115010590	6.23
81326200045	10.6	81511016485	30.14	85114318	20.14	8971205464	2.23	9115010600	6.23
81326200055	10.6	81519590	30.73	85116453	30.59	8971205474	2.23	9115010610	6.23
81327346044	10.3	81521706156	8.9	85117316	20.13	8971205504	2.23	9115010620	6.23
81327356041	24.5	81524006005	31.4	85139619	30.70	8971216104	2.23	9115011510	6.23
8133047	20.13	81524030028	31.4	8550977	25.40	8971216154	2.23	9115040520	6.24
814001601	17.17	81524030029	31.4	8550978	25.40	8971219234	2.23	9115040520	6.41
814001621	17.17	8154755	30.84	85999769	20.13	8997598820	30.51	9115040520	6.48
814002242	17.19	8156339	31.7	8694974519	20.3	8997605104	30.51	9115040560	6.24
8140024	30.66	8157359	30.58	8694974519	20.13	8998504944	7.5	9115040600	6.24
814003102	17.20	8158342	8.2	8695671105	20.13	90054007	14.7	9115040600	6.48
814003142	17.20	8158821	30.57	8695671106	20.13	90054630	14.17	9115045000	6.24
814004401	17.26	81619670011	7.4	8695671113	20.2	90054630	15.11	9115045010	6.24
814004411	17.26	8171245	10.4	8695955113	20.7	9012010	8.2	9115045020	6.24
814004411	30.49	8171247	10.4	8695955116	20.5	90216S	1.3	9115045030	6.24
814004421	30.49	8171386	10.7	8695955139	20.4	9033530	8.2	9115045060	6.22
814010101	17.17	8172628	10.5	8695955147	20.2	90364	1.16	9115045060	6.42
814011001	17.17	8172824	16.4	8695955147	20.9	9042026	8.2	9115045060	6.48
814019001	17.17	81930210397	31.4	8695955149	20.9	90548	1.2	9115051500	6.23
814019011	17.18	81965020208	32.2	8696955112	20.10	90554107	1.2	9115051500	6.41

Cross Reference	Page	Cross Reference	Page	Cross Reference	Page	Cross Reference	Page	Cross Reference	Page
9115051500	6.48	9125140010	6.27	9253214340	2.9	9254217520	2.10	9254310920	2.10
9115051510	6.23	9125140030	6.27	9253220150	2.9	9254221000	2.10	9254310940	2.10
9115051510	6.41	9125140040	6.27	9253220250	2.9	9254221020	2.10	9254310950	2.10
9115051510	6.48	9125140040	6.49	9253220810	2.9	9254221500	2.10	9254310980	2.10
9115060540	6.24	9125140090	6.42	9253220910	2.9	9254221510	2.10	9254311400	2.10
9115065000	6.25	9125180000	6.27	9253221020	2.9	9254221520	2.10	9254311430	2.10
9115065040	6.25	9125180010	6.27	9253222050	2.9	9254221530	2.10	9254311440	2.10
9115140010	6.11	9125180020	6.27	9253222150	2.9	9254221560	2.10	9254311450	2.10
9115148002	6.11	9125180030	6.27	9253222410	2.9	9254221570	2.10	9254314210	2.10
9115150010	6.25	9125180040	6.27	9253222500	2.9	9254221980	2.10	9254314220	2.10
9115150030	6.25	9125180040	6.42	9253222510	2.9	9254224230	2.10	9254314230	2.10
9115150080	6.25	9125180040	6.49	9253224240	2.9	9254224330	2.10	9254314830	2.10
9115150090	6.25	9125180050	6.28	9253227010	2.9	9254229020	2.10	9254314900	2.10
9115159212	6.25	9125180050	6.42	9253240000	2.9	9254229100	2.10	9254315150	2.10
9115159232	6.25	9125180050	6.49	9253240290	2.9	9254241000	2.10	9254315500	2.10
9115160100	6.25	9125181000	6.28	9253240400	2.9	9254248000	2.14	9254315510	2.10
9115530000	6.22	9125181010	6.28	9253241030	2.9	9254248010	2.14	9254321150	2.10
9115530010	6.22	9125181020	6.28	9253248010	2.9	9254248300	2.14	9254321170	2.10
9115530020	6.26	9125181020	6.28	9253251180	2.9	9254248310	2.14	9254321180	2.10
9115530030	6.22	9125181030	6.28	9253252160	2.9	9254249000	2.10	9254322010	2.10
9115530070	6.22	9125181030	6.42	9253290120	2.9	9254261000	2.14	9254324400	2.10
9115531000	6.26	9125181040	6.28	9253290210	2.9	9254261010	2.10	9254324810	2.10
9115531010	6.26	9125182000	6.28	9253291210	2.10	9254262000	2.14	9254324820	2.10
9115531030	6.26	9125182010	6.28	9253751000	2.3	9254262010	2.14	9254324830	2.11
9115531040	6.26	9125182020	6.28	9253761010	2.3	9254270100	2.10	9254324840	2.11
9115531040	6.48	9125182030	6.28	9253761220	2.3	9254270110	2.10	9254324850	2.11
9115531050	6.26	9125182040	6.28	9253771000	2.3	9254271000	2.9	9254324860	2.11
9115532000	6.25	9125182050	6.28	9253840502	2.3	9254271020	2.9	9254324870	2.11
9115532030	6.25	9125182060	6.28	9254201030	2.10	9254271100	2.10	9254329280	2.11
9121160000	6.9	9125182060	6.41	9254204060	2.10	9254271130	2.10	9254391100	2.11
9121160000	6.42	9125182070	6.28	9254205020	2.10	9254271140	2.10	9254394050	2.11
9121160000	6.49	9125189252	6.28	9254207010	2.9	9254290020	2.9	9254394060	2.11
9121170000	6.9	9125220000	6.28	9254207500	2.10	9254290500	2.10	9254600270	2.14
9121170000	6.42	9125220010	6.28	9254209010	2.10	9254290510	2.10	9254600320	2.14
9121170000	6.48	9125220020	6.28	9254209020	2.10	9254290610	2.10	9254600600	2.14
912180030	6.49	9125229242	6.28	9254209030	2.9	9254290620	2.10	9254600610	2.14
9122100000	6.12	917905	1.12	9254210850	2.9	9254291700	2.10	9254601000	2.14
9122100000	6.49	9213990120	16.7	9254211070	2.10	9254291760	2.10	9254601010	2.14
9125100010	6.26	92200	3.7	9254211410	2.10	9254291770	2.10	9254610200	2.16
9125100010	6.49	92201	3.7	9254211420	2.10	9254291800	2.10	9254610220	2.14
9125101000	6.26	92202	3.7	9254211440	2.10	9254291810	2.10	9254610230	2.14
9125101010	6.26	92503	3.7	9254211450	2.10	9254291820	2.10	9254610250	2.14
9125101020	6.26	9253051180	2.9	9254211460	2.10	9254291840	2.10	9254610270	2.14
9125101030	6.26	9253051300	2.9	9254212000	2.9	9254291850	2.10	9254610350	2.14
9125101040	6.26	9253051400	2.9	9254212010	2.9	9254300300	2.10	9254610510	2.14
9125101040	6.49	9253200800	2.9	9254213420	2.9	9254300350	2.10	9254610520	2.14
9125102000	6.26	9253204000	2.9	9254213460	2.9	9254300360	2.10	9254610600	2.16
9125102000	6.49	9253205020	2.9	9254214520	2.10	9254300660	2.10	9254610610	2.16
9125103000	6.37	9253205430	2.9	9254214530	2.10	9254301430	2.10	9254610620	2.16
9125103030	6.37	9253205560	2.9	9254214700	2.10	9254301440	2.10	9254610950	2.14
9125120010	6.27	9253211600	2.9	9254215000	2.10	9254310330	2.10	9254610960	2.14
9125120060	6.27	9253212020	2.9	9254215010	2.10	9254310340	2.10	9254611010	2.14
9125120080	6.49	9253212030	2.9	9254215400	2.10	9254310370	2.10	9254611020	2.14
9125120150	6.49	9253212920	2.9	9254215510	2.10	9254310380	2.10	9254611030	2.14
9125120290	6.49	9253214180	2.9	9254217500	2.10	9254310630	2.10	9254611100	2.14
9125120330	6.27	9253214240	2.9	9254217510	2.10	9254310910	2.10	9254611200	2.14

CROSS REFERENCES

Manufacturers Part Numbers are for the purpose of reference only.

Cross Reference	Page	Cross Reference	Page	Cross Reference	Page	Cross Reference	Page	Cross Reference	Page
9254611300	2.14	9254800210	2.14	9254812310	2.15	9254871100	2.15	9254920000	2.11
9254611310	2.14	9254800340	2.14	9254812510	2.15	9254880000	2.15	9254920010	2.11
9254611500	2.14	9254800350	2.14	9254812520	2.14	9254880010	2.15	9254920020	2.11
9254611530	2.14	9254800400	2.14	9254812530	2.15	9254880100	2.16	9254920030	2.11
9254611600	2.14	9254801200	2.16	9254812600	2.16	9254880120	2.16	9254921010	2.11
9254611720	2.14	9254801210	2.14	9254813000	2.15	9254880140	2.16	9254921020	2.11
9254611730	2.14	9254809610	2.14	9254813120	2.15	9254880150	2.16	9254922000	2.11
9254611910	2.14	9254809620	2.14	9254813130	2.15	9254880200	2.16	9254922010	2.11
9254612100	2.14	9254810000	2.15	9254813200	2.14	9254880210	2.16	9254922030	2.11
9254612110	2.14	9254810120	2.15	9254813200	2.15	9254880400	2.16	9254922040	2.11
9254612310	2.14	9254810130	2.15	9254813210	2.15	9254880410	2.16	9254922050	2.11
9254612410	2.14	9254810150	2.15	9254813300	2.16	9254880600	2.16	9254922080	2.11
9254612700	2.14	9254810210	2.14	9254813310	2.15	9254880610	2.16	9254922090	2.11
9254612710	2.14	9254810300	2.15	9254813320	2.15	9254890200	2.16	9254922130	2.11
9254612900	2.14	9254810310	2.15	9254813330	2.15	9254891000	2.16	9254922210	2.11
9254612930	2.14	9254810320	2.15	9254813340	2.15	9254891010	2.16	9254922310	2.11
9254613300	2.14	9254810500	2.15	9254813360	2.16	9254901010	2.11	9254922710	2.9
9254613310	2.14	9254810510	2.15	9254813400	2.15	9254901020	2.11	9254928610	2.9
9254613500	2.14	9254810600	2.15	9254813420	2.15	9254901070	2.11	9254928710	2.9
9254613510	2.14	9254810700	2.15	9254813450	2.15	9254907550	2.11	9254929010	2.9
9254614690	2.14	9254810800	2.15	9254813460	2.15	9254909050	2.11	9254929030	2.11
9254614700	2.14	9254811000	2.15	9254813470	2.16	9254909060	2.11	9254941050	2.11
9254614710	2.14	9254811010	2.15	9254813600	2.15	9254910300	2.11	9254941060	2.9
9254614720	2.14	9254811020	2.15	9254813610	2.15	9254910310	2.11	9254941080	2.11
9254614800	2.14	9254811030	2.15	9254814200	2.15	9254910320	2.11	9254949100	2.11
9254615010	2.14	9254811080	2.15	9254814210	2.15	9254911030	2.11	9254949110	2.11
9254635100	2.14	9254811100	2.15	9254814240	2.15	9254911040	2.11	9254949200	2.11
9254635110	2.14	9254811130	2.15	9254814250	2.15	9254911050	2.11	9254949220	2.11
9254640400	2.14	9254811140	2.14	9254840100	2.16	9254911060	2.11	9254949230	2.11
9254644500	2.14	9254811150	2.15	9254840110	2.16	9254911070	2.11	9254990000	2.11
9254644510	2.14	9254811170	2.15	9254840200	2.15	9254911080	2.11	9254990010	2.11
9254644520	2.14	9254811200	2.15	9254840210	2.15	9254911100	2.11	9254990030	2.11
9254644600	2.14	9254811210	2.15	9254840220	2.15	9254911110	2.11	9254990040	2.11
9254644610	2.14	9254811220	2.15	9254840230	2.15	9254911150	2.11	9254990110	2.11
9254645000	2.14	9254811230	2.15	9254860100	2.16	9254911160	2.11	9254990120	2.11
9254645010	2.14	9254811250	2.15	9254860110	2.16	9254911170	2.11	9254990300	2.11
9254661020	2.14	9254811500	2.16	9254860400	2.16	9254911180	2.11	9254990310	2.11
9254670000	2.14	9254811510	2.16	9254861010	2.15	9254911220	2.11	9254990800	2.11
9254670020	2.14	9254811520	2.15	9254861040	2.15	9254911230	2.11	9254990810	2.11
9254670040	2.14	9254811530	2.15	9254861060	2.15	9254911240	2.11	9255001600	2.11
9254670050	2.14	9254811540	2.15	9254861070	2.15	9254911300	2.11	92573S	1.12
9254670120	2.14	9254811550	2.15	9254863000	2.15	9254911310	2.11	9259500157	2.22
9254670160	2.14	9254811560	2.15	9254863010	2.15	9254911320	2.11	92671S	1.12
9254670200	2.14	9254811570	2.15	9254863050	2.15	9254911330	2.11	92693S	1.12
9254670240	2.14	9254811600	2.15	9254863060	2.15	9254911340	2.11	92695S	1.12
9254681000	2.14	9254811610	2.15	9254863070	2.15	9254911350	2.11	92796	1.12
9254681400	2.14	9254811620	2.15	9254864000	2.15	9254911410	2.11	92793S	1.12
9254681410	2.14	9254811630	2.15	9254864010	2.15	9254911430	2.11	92797S	1.12
9254682500	2.14	9254811640	2.16	9254864110	2.15	9254911510	2.9	9281000042	16.7
9254682510	2.14	9254811650	2.16	9254864200	2.15	9254914300	2.11	9281000067	16.7
9254682520	2.14	9254811700	2.15	9254864210	2.15	9254914330	2.11	92939S	1.12
9254800040	2.16	9254811710	2.15	9254870000	2.15	9254914400	2.11	9305841138	10.8
9254800050	2.16	9254811720	2.16	9254870010	2.15	9254914410	2.11	93096	1.2
9254800100	2.16	9254811810	2.15	9254870100	2.15	9254917550	2.11	93097	1.2
9254800110	2.16	9254812000	2.15	9254870210	2.15	9254919000	2.11	93101S	1.3
9254800200	2.14	9254812300	2.15	9254870220	2.15	9254919010	2.11	93102S	1.3

Cross Reference	Page	Cross Reference	Page	Cross Reference	Page	Cross Reference	Page	Cross Reference	Page
93190556	10.3	9347021920	18.8	9347141370	18.11	950364048	17.4	950800442	30.49
9320020000	1.12	9347022100	18.8	9347141450	18.11	950364061	17.27	950800443	30.49
9320021000	1.12	9347022200	18.8	9347141500	18.11	950364075	17.5	950800444	30.49
9320021010	1.12	9347022210	18.8	9347141510	18.11	950364076	17.5	950800445	30.49
9320021020	1.12	9347022230	18.8	9347141520	18.11	950364077	17.5	950800446	30.49
9324000010	1.10	9347022400	18.8	9347142110	18.11	950364081	17.2	950800447	30.49
9324000020	1.10	9347022500	18.8	9347143200	18.11	950364101	17.2	950800451	17.20
9324000030	1.10	9347022520	18.8	9347144000	18.11	950364102	17.2	950800452	17.20
9324000040	1.10	9347022600	18.8	9347144010	18.11	950364103	17.2	950800453	17.20
9324000050	1.10	9347022610	18.8	9347144030	18.11	950364104	17.5	950800454	17.21
9324000060	1.10	9347022700	18.9	9347147300	18.11	950364108	17.27	950800455	17.21
9324000140	1.10	9347022710	18.9	9347147320	18.11	950364211	17.5	950800456	17.21
9324000160	1.10	9347023000	18.9	9347147400	18.11	950364404	17.19	950800462	17.18
9324000180	1.10	9347023020	18.9	93522	1.10	950364405	17.19	950800463	17.18
9324000210	1.10	9347023200	18.9	93729	1.2	950364407	17.19	950800471	17.18
9324000240	1.10	9347023220	18.9	9423340115	31.5	950364418	17.19	950800472	17.18
9325000030	4.4	9347023230	18.9	9423560015	31.5	950364419	17.19	950800474	17.18
9325000060	4.4	9347023300	18.9	9423560315	31.5	950364421	17.19	950800475	17.18
9325000070	4.4	9347023400	18.9	9423560715	31.5	950364422	17.19	950800476	17.18
9325000130	4.4	9347023420	18.9	9425420	30.64	950364425	17.19	950800481	17.17
9325000140	4.4	9347023800	18.9	943044	32.3	950364426	17.19	950800483	17.17
9325000150	4.4	9347023810	18.9	9432600209	10.8	950364429	17.19	950800484	17.17
9325000210	4.4	9347023870	18.9	9432600809	10.8	950364501	30.10	950800486	90.11
9325000350	4.4	9347023880	18.9	9432601109	10.8	950364502	30.10	950800903	17.26
9325000400	4.4	9347023910	18.9	9432601209	10.8	950364503	30.10	950800907	17.26
9325001010	4.4	9347050020	18.9	9432601309	10.9	950364506	30.10	950800909	90.11
9325001020	4.4	9347050030	18.9	9432601509	10.9	950364801A	17.2	950800915	90.11
9325001030	4.4	9347050040	18.9	9432601609	10.9	950364802	17.2	950820001	17.13
9325001100	4.4	9347050050	18.9	9433340115	31.5	950364803	17.2	950823008	17.13
9325100090	4.4	9347050060	18.9	943703	32.3	950364804	17.2	950823008K	17.13
9325100100	4.4	9347050080	18.10	9441032808	30.11	950364806	17.5	9520435	30.84
9325100500	4.4	9347130030	18.10	94520021320	90.4	950364807	17.5	9522000210	90.2
9325109132	90.9	9347130040	18.10	9453340351	31.5	950800201	17.12	9522000220	90.2
9325109562	4.4	9347130190	18.10	94605	3.7	950800202	17.12	9522002210	90.2
9325109582	4.4	9347140010	18.10	9463340015	31.5	950800203	17.12	9522002220	90.2
9325109582	18.7	9347140030	18.10	9463340115	31.4	950800204	17.12	9522010010	90.3
9343000010	1.13	9347140040	18.10	9463340515	31.5	950800302	17.13	9522010020	90.3
9343000030	1.13	9347140060	18.10	9463340615	31.5	950800303	17.13	9522010030	90.3
9343000070	1.13	9347140100	18.10	950310009	1.10	950800304	17.13	9522010040	90.3
9347010000	18.7	9347140110	18.10	950310009	1.11	950800305	17.13	9522010070	90.3
9347010410	18.7	9347140120	18.10	950310014	1.2	950800306	17.13	9522010080	90.3
9347020000	18.7	9347140140	18.10	950338036	26.13	950800401	17.19	95396	3A.7
9347020020	18.7	9347140150	18.10	950338038	26.14	950800402	17.20	955163	20.7
9347020050	18.7	9347140160	18.10	950338100	26.14	950800403	17.20	95620	3.7
9347020400	18.7	9347140180	18.10	950352017	26.14	950800404	17.20	95620C	3.7
9347020410	18.7	9347140190	18.10	950352022	26.13	950800405	17.20	95621	3.7
9347020420	18.8	9347140280	18.10	950352022	26.14	950800406	17.20	95621C	3.7
9347020450	18.8	9347140300	18.10	950352023	26.14	950800411	17.20	9605420617	30.65
9347020470	18.8	9347140370	18.10	950352024	26.14	950800412	17.20	9617011000	12.5
9347020820	18.8	9347141100	18.10	950352110	26.13	950800421	17.20	9617011050	12.5
9347020830	18.8	9347141190	18.11	950352111	26.13	950800422	17.20	9617011060	12.5
9347021000	18.8	9347141230	18.11	950364018	17.5	950800424	17.20	9617011100	12.5
9347021010	18.8	9347141250	18.11	950364021	17.27	950800431	17.17	9617020010	12.5
9347021100	18.8	9347141260	18.11	950364045	17.4	950800433	17.17	9617020040	12.5
9347021220	18.8	9347141280	18.11	950364046	17.4	950800434	17.17	9617020080	12.5
9347021910	18.8	9347141320	18.11	950364047	17.4	950800441	30.49	9617020140	12.5

CROSS REFERENCES

Manufacturers Part Numbers are for the purpose of reference only.

Cross Reference	Page	Cross Reference	Page	Cross Reference	Page	Cross Reference	Page	Cross Reference	Page
9617020310	12.5	9617230010	12.8	9617232050	12.11	9700511540	5.11	9700519692	30.71
9617030010	12.5	9617230020	12.8	9617232070	12.11	9700511570	5.11	9700520010	5.14
9617210000	12.5	9617230030	12.8	9617232080	12.11	9700511580	5.11	9701500010	5.14
9617210040	12.5	9617230040	12.8	9617232120	12.11	9700511590	5.11	9701900280	5.13
9617210100	12.5	9617230050	12.8	9617232130	12.11	9700511630	5.11	9701900340	5.13
9617210110	12.5	9617230070	12.8	9617232150	12.11	9700511640	5.11	9702600457	8.8
9617210170	12.5	9617230080	12.8	9617232170	12.11	9700511680	5.11	9703560415	31.4
9617210190	12.5	9617230100	12.8	9617234030	12.11	9700511690	5.11	9703560615	31.5
9617210200	12.5	9617230110	12.8	9617234050	12.11	9700511710	5.11	97100200000	23.10
9617210330	12.5	9617230120	12.8	9617234110	12.11	9700511740	5.11	9710021500	23.10
9617210400	12.5	9617230150	12.8	9617234180	12.11	9700511760	5.11	9710021520	23.10
9617210440	12.6	9617230160	12.8	9617234200	12.11	9700511790	5.11	9710021550	23.10
9617210540	12.6	9617230170	12.8	9617234210	12.11	9700511810	5.11	9710021570	23.10
9617221500	12.6	9617230190	12.8	9617234240	12.11	9700511820	5.11	9710022000	23.10
9617221510	12.6	9617230210	12.9	9617242000	12.12	9700511830	5.11	9710023000	23.11
9617221560	12.6	9617230220	12.9	9617242080	12.12	9700511900	5.11	9710023010	23.11
9617221580	12.6	9617230230	12.9	9617242090	12.12	9700511910	5.11	9710023030	23.11
9617221600	12.6	9617230250	12.9	9617242110	12.12	9700511920	5.11	9710023040	23.11
9617221700	12.6	9617230260	12.9	9617242240	12.12	9700511930	5.12	9710023070	23.11
9617221720	12.6	9617230270	12.9	9617242250	12.12	9700511940	5.12	9710023080	23.11
9617221730	12.6	9617230280	12.9	9618940097	9.6	9700512040	5.12	9710025300	23.11
9617221790	12.6	9617230300	12.9	9630010120	26.11	9700512050	5.12	9710025310	23.11
9617221800	12.6	9617230310	12.9	9630010130	26.11	9700512090	5.12	9710025320	23.11
9617222100	12.6	9617230360	12.9	9630010160	26.12	9700512170	5.12	9710025330	23.11
9617222120	12.6	9617230380	12.9	9630010510	26.12	9700512180	5.12	9710025700	23.11
9617222140	12.6	9617230390	12.9	9630010520	26.12	9700512200	5.12	9710026200	23.11
9617222320	12.6	9617230400	12.9	9630060010	26.12	9700512240	5.12	9710027000	23.12
9617222500	12.6	9617230410	12.8	9630060030	26.12	9700513070	5.12	9710027010	23.12
9617222510	12.6	9617230410	12.9	9630060050	26.12	9700514020	5.12	9710027040	23.12
9617222520	12.6	9617231000	12.9	9630060060	26.12	9700514050	5.12	9710028020	23.12
9617222530	12.7	9617231020	12.9	9630060080	26.12	9700514060	5.12	9710028050	23.12
9617222540	12.7	9617231040	12.9	96392	16.3	9700514070	5.12	9710029000	26.12
9617222580	12.7	9617231070	12.9	9640010020	26.12	9700514120	5.12	9710029020	26.12
9617222600	12.7	9617231080	12.9	9650010012	9.18	9700514130	5.12	9710029100	26.12
9617222620	12.7	9617231090	12.9	9650010022	9.18	9700514140	5.12	9710029120	26.12
9617222640	12.7	9617231100	12.10	9650010052	9.18	9700514150	5.12	9710029130	26.13
9617222650	12.7	9617231110	12.10	9650010102	9.18	9700514190	5.12	9710029212	23.16
9617222660	12.7	9617231120	12.10	9650019022	16.7	9700514220	5.12	9721950450	17.8
9617222670	12.7	9617231150	12.10	9651000010	30.74	9700514230	5.13	9723340115	31.5
9617222690	12.7	9617231160	12.10	9700511020	5.10	9700514240	5.13	9730010100	23.12
9617222720	12.7	9617231170	12.10	9700511070	5.10	9700514290	5.13	9730010200	23.12
9617222750	12.7	9617231180	12.10	9700511110	5.10	9700514300	5.13	9730012100	23.12
9617222840	12.7	9617231220	12.10	9700511140	5.10	9700514310	5.13	9730012110	23.12
9617222860	12.7	9617231230	12.10	9700511240	5.10	9700514320	5.13	9730012210	23.12
9617222880	12.7	9617231240	12.10	9700511260	5.10	9700514350	5.13	9730020000	27.7
9617222920	12.7	9617231250	12.10	9700511270	5.10	9700514360	5.13	9730020070	27.7
9617223020	12.7	9617231260	12.10	9700511280	5.10	9700514370	5.13	9730020100	27.8
9617223050	12.7	9617231270	12.10	9700511290	5.10	9700514380	5.13	9730020130	27.8
9617223060	12.7	9617231320	12.10	9700511310	5.10	9700514390	5.13	9730020220	27.8
9617223120	12.7	9617231340	12.10	9700511320	5.10	9700514410	5.13	9730020700	27.8
9617223130	12.8	9617231390	12.10	9700511350	5.10	9700514430	5.11	9730021200	27.8
9617223140	12.8	9617231400	12.10	9700511360	5.10	9700514510	5.13	9730024020	27.8
9617223240	12.8	9617232000	12.10	9700511370	5.10	9700514540	5.13	9730024030	27.8
9617223250	12.8	9617232010	12.10	9700511500	5.10	9700514650	5.13	9730024060	27.8
9617223260	12.8	9617232030	12.10	9700511510	5.10	9700514660	5.13	9730024090	27.8
9617226890	12.8	9617232040	12.11	9700511520	5.11	9700516010	5.13	9730024180	27.8

Cross Reference	Page	Cross Reference	Page	Cross Reference	Page	Cross Reference	Page	Cross Reference	Page
9730024190	27.8	9730111010	23.14	9753030910	11.4	A0009058511	34.6	AB2762	27.3
9730024220	27.8	9730111040	23.14	9753031200	11.4	A0015421718	30.54	AB2774	27.3
9730024230	27.9	9730111050	23.14	9753031210	11.4	A0018214860	30.60	AB2777	27.3
9730024250	27.9	9730111060	23.14	9753031410	11.4	A0022604657	10.4	AB2783	27.3
9730024300	27.8	9730111070	23.15	9753032200	11.4	A0022607457	10.4	AB2793	27.3
9730024500	27.9	9730111090	23.15	9753034410	11.4	A0024522618	30.20	AB2795	27.3
9730025000	27.9	9730111100	23.15	9753034420	11.4	A0025422718	30.20	AB2798	27.3
9730025010	27.9	9730112000	23.15	9753034460	11.4	A0025423005	30.20	AB2802	27.3
9730025050	27.9	9730112010	23.15	9753034470	11.4	A0025423818	30.20	AB2810	27.3
9730025200	27.9	9730112030	23.15	9753034640	11.4	A0025425818	30.54	AB2831	27.3
9730025210	27.9	9730112050	23.15	9753034650	11.4	A0025453914	30.78	AB2835	27.3
9730025220	27.9	9730112060	23.15	9753034690	11.4	A0041534228	30.82	AB2840	27.3
9730025230	27.9	9730112080	23.15	9753034720	11.4	A0041536328	30.65	AB2846	27.3
9730025280	27.9	9730112500	23.15	9753034730	11.4	A0045455514	30.56	AB2851	27.3
9730025320	27.9	9730113000	23.15	9753034740	11.4	A0005455414	30.78	AC135HYZ	11.4
9730025350	27.10	9733561015	31.5	9753034790	11.4	A0061530428	30.81	AC152DA	21.4
9730025390	27.10	9735000000	22.7	9753034800	11.4	A0061530728	30.81	AC152DX	21.4
9730026200	27.10	9735000030	22.7	9753034900	11.4	A0061534528	30.82	AC155F	21.4
9730030000	23.12	9735000060	22.7	9753034910	11.4	A0061534528	34.11	AC155FA	21.4
9730030020	23.12	9735000110	22.7	9753035030	11.4	A0061537428	30.56	AC156A	21.4
9730030060	23.13	9735000140	22.7	9753035040	11.4	A0061537428	34.10	AC156B	21.4
9730030070	23.13	9735000180	22.9	9753035410	11.4	A0061537528	30.56	AC156C	21.4
9730030080	23.13	9735000280	22.9	9753035800	11.4	A0061537528	34.10	AC156D	21.4
9730030100	23.13	9735000310	22.9	9753036610	11.4	A0065424617	30.62	AC156E	21.4
9730030120	23.13	9735000340	22.9	9753340415	31.5	A0075426018	30.54	AC157C	21.4
9730060000	23.13	9735000380	22.9	9754000390	11.2	A0081539928	34.4	AC157G	21.4
9730060010	23.13	9735000390	22.9	9754000830	11.2	A0081539928	34.5	AC157L	21.4
9730060030	23.13	9735000420	22.9	9754000940	11.2	A0091533628	34.4	AC157M	21.4
9730080050	27.10	9735000440	22.10	9763560015	31.5	A0065427618	30.20	AC157P	21.4
9730080070	27.10	9735000450	22.10	98419513	30.11	A0075424818	30.82	AC399A	24.3
9730090010	27.10	9735000510	22.10	99100180008	10.3	A0095421017	30.62	AC571AX	23.8
9730090020	27.10	9735000530	22.10	99484667	30.67	A0101531428	34.4	AC574AA	23.8
9730090050	27.10	9735000570	22.10	9955936	30.33	A0101531428	34.5	AC574AXY	23.8
9730090060	27.10	9735000590	22.10	9958574	30.34	A0101531528	34.5	AC574BYW	23.8
9730090070	27.10	9740100010	5.13	9C462296AA	25.40	A0101531628	34.5	AC574CXY	23.8
9730090090	27.10	9740100080	16.7	A.75056.3	2.23	A0101531728	34.4	AC575A	23.8
9730090100	27.10	9741005332	16.10	A.75056.4	2.23	A0101531728	34.5	AC577A	23.8
9730090130	27.11	9750010000	21.6	A.75056.5	2.23	A0101531928	34.6	AC577B	23.8
9730090150	27.11	9750010010	21.6	A.75056.7	2.23	A0101538128	34.6	AC579BK	23.6
9730090160	27.11	9750010020	21.6	A0000906050	20.2	A0101539328	34.4	AC586A	23.8
9730090180	27.11	9750020010	21.6	A0001404139	34.8	A0101539328	34.5	AC586AAX	23.8
9730090220	27.11	9750020020	21.6	A0001404478	34.6	A0101539528	34.4	AC586AY	23.8
9730091000	27.11	9750020050	21.6	A0001404478	34.8	A0101539628	34.4	AC590A	27.3
9730091200	27.11	9750020170	21.6	A0001420289	34.8	A0125421017	30.81	AC591A	27.3
9730093000	27.11	9750090010	21.6	A0001420289	34.11	A0135427117	30.65	AC595A	27.3
9730110000	23.13	9753001100	11.4	A0001539932	30.67	A0135427217	30.65	AC595F	27.3
9730110010	23.13	9753030000	11.4	A0005404136	25.41	A0135427917	30.22	AC596A	27.3
9730110020	23.13	9753030400	11.4	A0005404136	30.53	A0145428717	34.7	AC597A	27.3
9730110040	23.13	9753030600	11.4	A0005422418	30.9	A0145428717	34.10	AC597B	27.3
9730110080	23.14	9753030610	11.4	A0009050008	34.5	A0155422717	30.62	AC597BA	27.3
9730110090	23.14	9753030720	11.4	A0009050108	34.6	A1614310103	30.81	AC597C	27.4
9730110100	23.14	9753030810	11.4	A0009053009	34.5	A9432601209	10.8	AC598A	27.4
9730110110	23.14	9753030820	11.4	A0009053109	34.5	A9452600757	8.8	AC598B	27.4
9730110140	23.14	9753030830	11.4	A0009053403	34.5	A9452601957	8.8	AC598C	27.4
9730110500	23.14	9753030860	11.4	A0009053503	34.5	A9604600280	20.10	AC599A	27.4
9730110670	23.14	9753030890	11.4	A0009053603	34.6	A970545012	30.64	ACHD274	16.6

CROSS REFERENCES

Manufacturers Part Numbers are for the purpose of reference only.

Cross Reference	Page	Cross Reference	Page	Cross Reference	Page	Cross Reference	Page	Cross Reference	Page
ACHD722	16.6	AE4428	18.3	APGA1617	5.14	BR4431	15.4	BS2403	2.6
ACX67A	6.27	AE4437	18.3	APGA1632	5.14	BR4439	15.4	BS2406	2.6
ACX67AA	6.27	AE4440	18.3	APGA1633	5.14	BR4440	15.4	BS2407	2.6
ACX67AAG	6.27	AE4447	18.3	APGA2527	2.22	BR4441	15.4	BS2408	2.6
ACX67AX	6.27	AE4448	18.3	APGA2537/CIEU	2.22	BR4442	15.4	BS2503	2.6
ACX67AZ	6.27	AE4449	18.4	APGA6552	9.6	BR4444	15.4	BS2504	2.6
ACX67AZG	6.27	AE4452	18.4	APGA6566	9.6	BR4452	15.4	BS2505	2.6
ACX67BA	6.27	AE4502	18.4	APGA6620	9.6	BR4453	15.4	BS2514	2.6
ACX67BAG	6.27	AE4503	18.4	APGA6635/A	12.3	BR4454	15.4	BS2515	2.6
ACX68D	6.27	AE4505	18.4	APGA6661	9.6	BR4455	15.4	BS2523	2.6
ACX69D	6.45	AE4506	18.4	APGA6714/EU	9.6	BR4456	15.4	BS2524	2.6
ACX75ZB	6.27	AE4510	18.4	APSA10473/1	23.4	BR4457	15.4	BS2546	2.6
ACX75ZF	6.27	AE4516	18.4	APSA2870	11.2	BR4465	15.4	BS3152	2.6
ACX75ZFG	6.27	AE4525	18.4	APSA2878	11.3	BR4466	15.4	BS3155	2.6
ACX75ZG	6.27	AE4526	18.4	APSA7222	9.6	BR4467	15.4	BS3201	2.6
ACX75ZM	6.27	AE4527	18.4	APSA7314/IB	9.6	BR4468	15.4	BS3207	2.6
ACX75ZMG	6.27	AE4528	18.4	APSA7314/IEU	9.6	BR4470	15.4	BS3212	2.6
ACX83A	6.28	AE4529	18.4	APSA7616/AEU	9.6	BR5325	15.4	BS3213	2.6
ACX83AS	6.28	AE4534	18.4	APSA7616/EU	9.6	BR5408	15.4	BS3215	2.6
ACX83B	6.28	AE4535	18.4	APSA9000/A	11.2	BR5503	6.44	BS3250	2.6
ACX83D	6.28	AE4560	18.4	APSA9006/2	11.2	BR5503	15.4	BS3261	2.6
ACX83D	6.45	AE4561	18.5	APSA9006/5	11.2	BR5504	15.4	BS3269	2.6
AE1103	26.6	AE4603	18.5	APSA9018	11.2	BR5522	15.4	BS3273	2.6
AE1109	26.6	AE4604	18.5	APSA9042	11.2	BR5524	15.4	BS3281	2.6
AE1122	26.6	AE4605	18.5	AR20-F02	7.2	BR5530	15.4	BS3300	2.6
AE1124	26.6	AE4608	18.5	AS3000A-B	23.6	BR5604	15.4	BS3301	2.6
AE1125	26.6	AE4609	18.5	AS3012	23.6	BR5607	15.4	BS3316	2.6
AE1207	10.2	AE4610	18.5	AS3018	23.6	BR5608	15.4	BS3317	2.6
AE4105	22.4	AE4611	18.5	AS3050A	23.6	BR5611	15.4	BS3324	2.6
AE4146	22.4	AE4612	18.5	AS3054	23.6	BR5615	15.4	BS3325	2.6
AE4158	18.2	AE4613	18.5	AS3100A	23.6	BR5616	15.4	BS3326	2.6
AE4162	18.2	AE4615	18.5	AS3250	23.6	BR5617	15.4	BS3332	2.6
AE4168	18.2	AE4616	18.5	B.54871	2.23	BR5619	15.4	BS3335	2.6
AE4170	18.2	AE4620	18.5	B.56649	2.23	BR5628	15.4	BS3336	2.6
AE4171	18.3	AE4623	18.5	B.58894	2.23	BR5633	15.4	BS3337	2.6
AE4178	18.3	AE4625	18.5	B.59171	2.23	BR5643	15.4	BS3350	2.6
AE4179	18.3	AE4642	18.5	B.61290	2.23	BR5645	15.4	BS3363	2.6
AE4183	18.3	AE4643	18.6	B.64322	2.23	BR5648	15.4	BS3364	2.6
AE4186	18.3	AE4644	18.6	B.7447.9	2.23	BR5655	15.4	BS3368	2.6
AE4188	18.3	AE4645	18.6	B.74478	2.23	BR5657	15.4	BS3369	2.6
AE4190	18.3	AE4646	18.6	BFMI22	2.17	BR5712	15.4	BS3401	2.6
AE4191	18.3	AE4648	18.6	BR4253	15.4	BR9131	17.6	BS3402	2.6
AE4196	18.3	AE4653	18.6	BR4255	15.4	BR9150	17.6	BS3403	2.6
AE4233	26.6	AE4654	18.6	BR4263	15.4	BR9151	17.6	BS3404	2.6
AE4233	26.11	AE4658	18.6	BR4265	15.4	BR9152	17.6	BS3409	2.6
AE4246	26.6	AE4800	18.6	BR4351	15.4	BR9154	17.6	BS3410	2.6
AE4247	26.6	AE5131	22.4	BR4352	15.4	BR9156	17.6	BS3411	2.6
AE4262	26.6	AE6000	18.6	BR4370	15.4	BR9159	17.6	BS3412	2.6
AE4311	26.6	AMPA694	3A.3	BR4410	15.4	BR9163	17.6	BS3413	2.6
AE4370	26.6	AMPA697	3A.3	BR4411	15.4	BR9180	17.6	BS3414	2.6
AE4404	18.3	AMPAB016	3A.3	BR4412	15.4	BR9190	17.6	BS3415	2.6
AE4405	18.3	APGA1605	5.14	BR4413	15.4	BR9231	17.6	BS3423	2.6
AE4407	18.3	APGA1608	5.14	BR4414	15.4	BR9232	17.6	BS3433	2.6
AE4408	18.3	APGA1610	5.14	BR4415	15.4	BR9233	17.6	BS3434	2.6
AE4409	18.3	APGA1611	5.14	BR4421	15.4	BR9234	17.6	BS3435	2.6
AE4427	18.3	APGA1613	5.14	BR4423	15.4	BS2402	2.6	BS3451	2.6

Cross Reference	Page	Cross Reference	Page	Cross Reference	Page	Cross Reference	Page	Cross Reference	Page
BS3452	2.6	BS8450	2.12	BS9305	2.12	BS9502	2.13	BZ6425	2.22
BS3458	2.6	BS8452	2.13	BS9306	2.12	BS9503	2.13	BZ6517	2.22
BS3467	2.6	BS8453	2.12	BS9311	2.12	BS9504	2.13	BZ6621	2.22
BS3471	2.6	BS8458	2.12	BS9312	2.12	BS9505	2.13	BZ7239	2.17
BS3472	2.6	BS8459	2.12	BS9314	2.12	BS9506	2.13	BZ7240	2.17
BS3474	2.6	BS8460	2.12	BS9320	2.13	BS9507	2.13	BZ7251	2.17
BS3475	2.6	BS8461	2.12	BS9321	2.13	BS9508	2.13	BZ7252	2.17
BS3501	2.6	BS8472	2.12	BS9332	2.12	BS9510	2.13	BZ7419	2.9
BS3508	2.6	BS8473	2.12	BS9338	2.12	BS9514	2.13	BZ7589	2.20
BS3509	2.6	BS8500	2.12	BS9339	2.12	BS9519	2.13	BZ9331	2.9
BS3514	2.6	BS8502	2.12	BS9342	2.12	BS9520	2.13	BZ9424	2.9
BS3515	2.6	BS8503	2.12	BS9343	2.12	BS9527	2.13	BZ9425	2.9
BS3516	2.6	BS8506	2.13	BS9350	2.12	BS9531	2.13	BZ9447	2.9
BS3520	2.6	BS8507	2.12	BS9351	2.12	BS9535	2.13	BZ9524	2.9
BS3521	2.6	BS8508	2.12	BS9354	2.12	BS9536	2.13	BZ9529	2.9
BS3522	2.6	BS8510	2.12	BS9355	2.12	BS9541	2.13	BZ9553	2.9
BS3526	2.6	BS8512	2.12	BS9362	2.12	BS9543	2.13	BZ9554	2.9
BS3528	2.6	BS8516	2.12	BS9363	2.12	BS9544	2.13	BZ9630	2.9
BS3532	2.6	BS8517	2.12	BS9370	2.12	BS9549	2.13	BZ9631	2.9
BS3536	2.6	BS8518	2.12	BS9371	2.12	BS9573	2.13	BZ9687	2.9
BS3537	2.6	BS8520	2.13	BS9373	2.12	BS9574	2.13	C3110002	24.2
BS3603	2.6	BS8533	2.12	BS9374	2.12	BT5417	2.13	CF102959	30.9
BS3605	2.6	BS8534	2.12	BS9379	2.12	BT5418	2.13	CL-9200A	7.2
BS3800	2.6	BS8544	2.13	BS9387	2.12	BT5718	2.13	CM-9424F6	26.8
BS3801	2.6	BS8545	2.13	BS9395	2.13	BT5719	2.13	D1252000	12.2
BS7309	2.2	BS8551	2.12	BS9396	2.13	BT5800	2.13	D1253060	12.2
BS8303	2.12	BS8552	2.12	BS9397	2.13	BT5801	2.13	D1410000	7.2
BS8316	2.12	BS8560	2.12	BS9404	2.13	BX3527	2.4	D1410240	7.2
BS8317	2.12	BS8561	2.12	BS9405	2.13	BX3550	2.4	D1410300	7.2
BS8322	2.12	BS8562	2.12	BS9406	2.13	BX3556	2.4	DB1102	21.3
BS8323	2.12	BS8563	2.12	BS9409	2.13	BY7136	2.17	DB1103	21.3
BS8328	2.13	BS8570	2.12	BS9410	2.13	BY9153	2.17	DB1151	21.3
BS8329	2.13	BS8571	2.12	BS9411	2.13	BY9205	2.17	DB1237	21.3
BS8330	2.13	BS8586	2.12	BS9412	2.13	BY9251	2.17	DB1240	21.3
BS8331	2.13	BS8587	2.12	BS9418	2.13	BY9260	2.17	DB2114	21.3
BS8332	2.12	BS9082	2.12	BS9419	2.13	BY9263	2.16	DB2115	21.3
BS8333	2.12	BS9083	2.12	BS9425	2.13	BY9264	2.16	DB2116	21.3
BS8334	2.12	BS9084	2.12	BS9426	2.13	BY9303	2.17	DB2118	21.3
BS8335	2.12	BS9086	2.12	BS9429	2.13	BY9321	2.16	DB2121	21.3
BS8337	2.12	BS9087	2.12	BS9433	2.13	BY9321	2.17	DB2122	21.3
BS8392	2.12	BS9088	2.12	BS9434	2.13	BY9328	2.17	DB2123	21.3
BS8393	2.12	BS9089	2.12	BS9438	2.13	BY9338	2.16	DPM21A	12.4
BS8402	2.13	BS9092	2.12	BS9451	2.13	BY9339	2.16	DPM21AK	12.4
BS8403	2.13	BS9093	2.12	BS9461	2.13	BY9350	2.17	DPM22AK	12.4
BS8413	2.13	BS9177	2.12	BS9462	2.12	BY9351	2.17	DPM23A	12.4
BS8414	2.13	BS9178	2.12	BS9463	2.12	BY9372	2.17	DPM23AK	12.4
BS8415	2.13	BS9196	2.12	BS9468	2.13	BY9401	2.17	DPM24AK	12.4
BS8420	2.12	BS9197	2.12	BS9476	2.13	BY9451	2.17	DPM28A	12.4
BS8421	2.12	BS9198	2.12	BS9480	2.13	BZ1700	24.2	DPM29A	12.4
BS8426	2.13	BS9253	2.12	BS9481	2.13	BZ3353	2.4	DPM43A	12.4
BS8427	2.13	BS9254	2.12	BS9482	2.13	BZ3490	2.4	DPM60A	12.4
BS8430	2.12	BS9261	2.12	BS9483	2.13	BZ3491	2.4	DPM60AA	12.4
BS8434	2.12	BS9282	2.12	BS9484	2.13	BZ3589	2.4	DPM60EY	12.4
BS8435	2.12	BS9297	2.12	BS9491	2.13	BZ3593	2.4	DPM61EY	12.4
BS8436	2.12	BS9302	2.13	BS9492	2.13	BZ3598	2.4	DPM63AX	12.4
BS8437	2.12	BS9304	2.12	BS9500	2.13	BZ3599	2.4	DPM64A	12.4

CROSS REFERENCES

Manufacturers Part Numbers are for the purpose of reference only.

Cross Reference	Page	Cross Reference	Page	Cross Reference	Page	Cross Reference	Page	Cross Reference	Page
DPM65A	12.4	DX50AX	9.10	EVT317-5DZ-02F-Q	7.3	I86888	14.9	II30530	14.11
DPM66A	12.4	DX51CX	9.10	FBU9864	16.5	I87237	2.27	II30531	14.11
DPM66ELK	12.4	DX52B	9.10	HB1133	12.3	I87432	14.10	II31227	2.13
DPM67AK	12.4	DX52BY	9.10	HB1142	12.3	I87433	14.10	II32582N00	4.2
DPM80A	12.4	DX53AX	9.10	HB1143	12.3	I87538	10.3	II32612	17.6
DPM80AX	12.4	DX60A	9.10	HB1144	12.3	I87823	14.9	II32763	14.9
DPM80B	12.4	DX61A	9.10	HB1147	12.3	I87893	10.3	II32764	14.9
DPM80BY	12.4	DX65A	9.10	HB1170	12.3	I87950	14.10	II32765	14.9
DPM84AX	12.4	DX65B	9.10	HB1172	12.3	I90452	14.10	II33045	14.9
DPM84C	12.4	DX65C	9.10	HB1175	12.3	I90706	14.8	II33582	17.3
DPM84CY	12.4	DX70A	9.10	HB1176	12.3	I90708	14.8	II34439	14.12
DPM85AX	12.4	DX70C	9.10	HB1179	12.3	I90969	26.7	II34910	14.12
DPM90A	12.4	DX70D	9.10	HB1189	12.3	I92103	14.9	II35417500	17.21
DPM90AA	12.4	DX75BA	9.11	HB1204	12.3	I92104	14.9	II354183000	17.21
DPM90B	12.4	DX75BAY	9.11	HB1240	12.3	I92567	14.10	II35530170	4.2
DPM90CK	12.4	DX75BBA	9.11	HB1241	12.3	I92568	14.10	II35531	4.2
DPM90D	12.4	DX75BX	9.11	HB1350	12.3	I92700	26.7	II36006	4.2
DPM90DA	12.4	DX80A	9.11	I40405	22.4	I92737	26.7	II36026	14.10
DPM90DDX	12.4	DX80D	9.11	I47854	14.8	I93270	17.6	II36027	14.10
DPM90DE	12.4	DX80E	9.11	I58921	14.8	I93362	27.3	II36043	26.7
DPM90DEY	12.4	DX81E	9.11	I60496	26.6	I93422	14.10	II36075	26.7
DPM90EY	12.4	DX95BXY	9.11	I63748	24.3	I93497	14.10	II36088	14.12
DPM91A	12.4	DX95BY	9.11	I67763	26.6	I93498	14.10	II36114	14.12
DPM92A	12.4	DX95F	9.11	I73682	7.4	I94314	6.46	II36115	14.12
DPM92AB	12.4	DX95FX	9.11	I76067	6.45	I98289	14.11	II36125	26.6
DPM92B	12.4	E2810012	8.9	I76936	10.3	I98290	14.11	II36129	26.6
DPM92BK	12.4	EA2000	17.11	I77618	27.3	I98348	14.11	II36134	26.6
DPM92D	12.4	EE4106	1.13	I78964	10.2	I98349	14.11	II36141	14.12
DPM93D	12.4	EE4115	1.13	I79379	18.3	I99631	14.11	II36142	14.12
DPM94AAX	12.4	EF120FY	2.17	I79678	10.3	I99812	21.3	II36145	26.7
DPM94EY	12.4	EF120YES	2.17	I79713	10.2	II14385	6.45	II36169	14.12
DPM95AAX	12.4	EF90YE	2.17	I80086	14.8	II15332	27.3	II36171	14.12
DPM96AAX	12.4	EF90YES	2.17	I80093	14.8	II15687	17.6	II36225	26.7
DPM96EY	12.4	EK3013	17.21	I80095	14.8	II15729	14.11	II36226	26.7
DPM98A	12.4	EK3050	17.21	I80864	6.43	II15730	14.11	II36227	26.8
DPM98B	12.4	EK3100	17.22	I82456	14.9	II16189	14.11	II367395	17.22
DR3200	11.4	EK3108	17.22	I82622	2.27	II16190	14.11	II367397	17.22
DR3224	11.4	EK3110	17.22	I83153	26.7	II16278	17.6	II3674112000	17.22
DR3231	11.4	ELA1000	1.6	I83425	26.6	II16774	30.51	II3674115000	17.22
DR33A	11.4	EL1100	4.3	I83640	14.9	II17788	4.2	II37083N50	17.11
DR3500	11.4	EL1101	4.3	I83699	14.8	II17811	14.11	II37090N00	17.6
DR3502	11.4	EL1600	6.30	I84414	21.3	II17813	14.8	II37091N00	17.6
DR3515	11.4	EL2201	4.3	I85043	10.3	II17814	14.10	II37276	2.9
DR3524	11.4	EL9002	1.6	I85247	14.8	II17815	14.11	II37279	2.20
DR4132	22.2	ES1215	17.3	I85444	14.9	II18032	14.10	II38097F	2.17
DR4156	22.2	ES1301	17.9	I85564	24.3	II18033	14.9	II38310FN00	4.2
DR5118	21.3	ES1305	17.9	I85698	14.9	II18034	14.9	II38619FN00	4.2
DR5125	21.3	ES2041	17.11	I85883	14.9	II18035	14.10	II38659F	17.6
DX16B	9.10	ES2050	17.11	I85919	14.9	II18525000	2.16	II38789F004	1.11
DX16D	9.10	ES2053	17.11	I86022	26.7	II18526000	2.16	II39737F	1.11
DX16DY	9.10	ES2060	17.12	I86025	26.7	II19099	14.16	II39782	17.11
DX19A	9.10	ES2090	17.12	I86154	21.3	II19099	15.11	II39783	17.11
DX25A	9.10	ES5020	30.12	I86156	21.3	II19425	14.11	II39798	17.11
DX26A	9.10	EVT307-5DZ-01F-Q	7.3	I86157	21.3	II19802	26.6	II39866F	4.2
DX26B	9.10	EVT307-6DZ-01F-Q	7.3	I86158	21.3	II30522	17.6	II40100F	1.11
DX50A	9.10	EVT317-5D-02F-Q	7.3	I86159	21.3	II30525000	14.11	II40391F2	17.22

Cross Reference	Page	Cross Reference	Page	Cross Reference	Page	Cross Reference	Page	Cross Reference	Page
II40864FN00	17.6	K002709	3.7	K003805	3.4	AC579BK / K008433	23.6	K014682N00	4.2
II41053F	17.6	K002736N00	4.3	K003805	3.7	K008433	23.6	K014683N00	4.2
II41300F	1.11	K002797	3.4	K003806	3.4	K008457X00	6.43	K014684N00	4.3
JYE.011	2.3	K002797	3.7	K003806	3.7	K009161	3.4	K014712	1.11
K000026	3.9	K002798	3.4	K003807	3.4	K009162	3.4	K015308	3.9
K000027	3.9	K002798	3.7	K003807	3.7	K009162	3.7	K015380N00	26.6
K000073	14.11	K002919	3.7	K003808	3.4	K009460	1.11	K015384	7.3
K000085N50	17.10	K002920	3.7	K003808	3.7	K009936	24.3	K015432N00	17.8
K000086N50	17.11	K002923	3.7	K003809	3.4	K009970	2.13	K015518	6.44
K000088	17.11	K002924	3.7	K003809	3.7	K009971	2.13	K015849N00	26.6
K000089	17.11	K002962	3.4	K003810	3.4	K010079	12.4	K015857	1.12
K000264	14.12	K002963	3.4	K003810	3.7	K010195	24.3	K015874	5.16
K000394N00	4.2	K002964	3.4	K003811	3.4	K010198	24.3	K015875	5.16
K000395N00	4.2	K002964	3.7	K003811	3.7	K010243	1.11	K015875N50	5.16
K000396N00	4.2	K002965	3.4	K003812	3.4	K010515	4.2	K016080K50	9.20
K000913N50	17.10	K002965	3.7	K003812	3.7	K010593	4.2	K016515	3.7
K000914N50	17.10	K003089	14.8	K003813	3.4	K010732	1.2	K016602N00	1.4
K000917	17.11	K003090	14.8	K003813	3.7	K010732	1.12	K016654	23.7
K000917N50	27.4	K003192	3.7	K003814	3.4	K010765	3.9	K017224	7.3
K000918N50	27.4	K003193	3.7	K003814	3.7	K011479	3.9	K017864	3.9
K000919	17.11	K003236	17.9	K003815	3.4	K011545	3.4	K018810	6.18
K000921N50	17.11	K003779	3.4	K003815	3.7	K011546	3.4	K019309V04	17.12
K000922N50	17.11	K003779	3.7	K003816	3.4	K011867N00	1.6	K019312V04	17.12
K001002N00	4.2	K003780	3.4	K003816	3.7	K011986N00	4.2	K019312V04N50	17.12
K001105	3.9	K003780	3.7	K003825	3.7	K011987N00	4.2	K019319B90	17.12
K001275	3.9	K003781	3.4	K003826	3.7	K012242N00	4.2	K019319V04	17.12
K001349	22.4	K003781	3.7	K003902	3.17	K012243N00	4.2	K019340	17.12
K001411	17.11	K003782	3.4	K004236	17.9	K012245N00	4.2	K019342V02N00	17.12
K001458N00	4.2	K003782	3.7	K004246	17.9	K012246N00	4.2	K019349V02N50	17.12
K001459N00	4.2	K003783	3.4	K004570	3.4	K012501	2.3	K019350V02	17.12
K001494	3.9	K003783	3.7	K004570	3.7	K012502	2.3	K019819	13.2
K001505	3.9	K003784	3.4	K004571	3.4	K012619	3.9	K019819N50	13.2
K001507	3.9	K003784	3.7	K004571	3.7	K012633	3.4	K019820	13.2
K001510	3.9	K003785	3.4	K004572	3.4	K012633	3.7	K019821	13.2
K001520	3.9	K003786	3.4	K004572	3.7	K012634	3.4	K019858N50	5.16
K001529	3.9	K003789	3.7	K004573	3.4	K012634	3.7	K020020	17.11
K001530	3.9	K003790	3.7	K004573	3.7	K013160	3.4	K020020N50	17.11
K001531	3.9	K003791	3.4	K004580	3.7	K013160	3.7	K020022N50	17.11
K001916	3.9	K003791	3.7	K004581	3.7	K013161	3.4	K020023	17.11
K001927	3.9	K003792	3.4	K004679	3.9	K013161	3.7	K020023N50	17.11
K001982N00	4.2	K003792	3.7	K004997	4.2	K013173	3.4	K020024N50	17.11
K001983N00	4.2	K003793	3.4	K005481	3.7	K013174	3.4	K020123N00	26.6
K001984N00	4.2	K003793	3.7	K005482	3.7	K013175	3.4	K020622	17.11
K001985N00	4.2	K003794	3.4	K005589	14.8	K013175	3.7	K020623	17.11
K002018	26.7	K003794	3.7	K005590	14.8	K013176	3.4	K020623N50	27.4
K0020320	6.40	K003795	3.4	K005591	14.8	K013176	3.7	K020624	17.11
K00203200	6.43	K003796	3.4	K005606	3.9	K013177	3.4	K020624N50	27.4
K002241	4.2	K003797	3.4	K005610	3.4	K013178	3.4	K020741N50	4.3
K002274	17.21	K003798	3.4	K005610	3.7	K013203	3.7	K020741X50	4.3
K002275	17.21	K003798	3.7	K005611	3.4	K013204	3.7	K020742N50	4.3
K002276N00	17.21	K003799	3.4	K005611	3.7	K013672	3.9	K021202N50	17.10
K002280	17.21	K003799	3.7	K005686	1.11	K013727N50	5.16	K021203	17.10
K002281	17.21	K003800	3.4	K006096N00	17.21	K013741N00	14.14	K021203N50	17.10
K002334	14.10	K003800	3.7	K007388	6.47	K013984	16.5	K021204N50	17.10
K002335	14.8	K003803	3.7	K007498	4.2	K014065	3.4	K021874N00	5.3
K002647	14.12	K003804	3.7	K008431N00	17.22	K014066	3.4	K022011N00	16.5

CROSS REFERENCES

Manufacturers Part Numbers are for the purpose of reference only.

Cross Reference	Page	Cross Reference	Page	Cross Reference	Page	Cross Reference	Page	Cross Reference	Page
K02277N00	17.21	K040953K50	3.7	K102196	1.11	K2C0543SXA	2.20	KB2095	25.12
K022847N00	26.8	K040954K50	3.7	K105789K50	6.8	K2C2004X50	2.19	KB2100	25.15
K023213	17.11	K042283N00	4.3	K105906N50	4.3	K2D0706X50	2.19	KB2105	25.5
K023217N00	17.11	K043684N50	1.6	K105907N50	4.3	K2E4001X50	2.19	KB2110	25.5
K023219	17.10	K043824N00	4.3	K107293K50	1.14	K2E4002X50	2.19	KB2115	25.5
K023346	18.7	K043828N00	4.3	K109377N00	23.6	KB1000	25.33	KB2120	25.5
K023347	18.6	K043829N00	4.3	K114269	4.2	KB1000	25.34	KB2125	25.5
K023348	18.6	K043830N00	4.3	K114270	4.2	KB1005	25.31	KB2130	25.15
K023352	18.6	K043831N00	4.3	K114272	4.2	KB1010	25.31	KB2135	25.15
K024928N50	9.7	K043833N00	4.2	K114274	4.2	KB1020	25.32	KB2140	25.16
K024928X50	9.7	K043835	4.2	K116869N50	1.6	KB1025	25.33	KB2150	25.16
K025295N00	4.3	K043838N00	4.2	K116870N50	1.6	KB1025	25.37	KB2155	25.16
K025700N00	26.6	K043845N00	4.3	K116876N50	1.6	KB1030	25.34	KB2160	25.16
K026763	3.4	K043846N00	4.3	K116877N50	1.6	KB1035	25.34	KB2170	25.8
K026764	3.4	K043847N00	4.3	K116878N50	1.6	KB1040	25.34	KB2210	25.25
K028207	4.2	K043848N00	4.3	K116879N50	1.6	KB1046	25.31	KB2215	25.25
K032014N50	17.11	K043849N00	4.3	K116880N50	1.6	KB1055	25.33	KB2220	25.25
K032123N50	16.5	K043850N00	4.3	K1168871N50	1.6	KB1065	25.33	KB2230	25.21
K035001N00	6.45	K043851N00	4.3	K125877K50	17.6	KB1075	25.35	KB2235	25.8
K035570	7.3	K044300N50	1.6	K127624K50	1.11	KB1080	25.35	KB2240	25.21
K035696K50	4.5	K044694N50	9.7	K138263N50	4.3	KB1085	25.33	KB2250	25.25
K035696K50	23.6	K044696N50	9.7	K148329N50	4.3	KB1090	25.33	KB2260	25.25
K037584N00	15.4	K044873N00	5.3	K151739K50	3.4	KB1110	25.35	KB2265	25.25
K037585N00	15.4	K044874N00	5.3	K151740K50	3.4	KB1115	25.35	KB2270	25.25
K038408N50	17.6	K046498K50	3.9	K153293N50	12.4	KB1120	25.35	KB2275	25.28
K038435N03	17.6	K046528K50	3.4	K153968N00	2.9	KB1125	25.31	KB2280	25.28
K0384381N50	17.6	K046529K50	3.4	K157264N00	6.8	KB1130	25.35	KB2285	25.28
K0384382N50	17.4	K049547N00	5.3	K157264N00	6.46	KB1135	25.35	KB2290	25.28
K0384382N50	17.6	K050210	17.11	K162503N00	6.19	KB1160	25.35	KB2295	25.28
K038438N50	17.6	K050211	17.10	K162503N00	6.46	KB1170	25.33	KB2300	25.29
K038653N00	6.18	K052379K50	3.9	K162974N50	12.4	KB1315	25.33	KB2305	25.5
K038653N00	6.44	K052380K50	3.4	K168097N00	6.43	KB1330	25.35	KB2310	25.14
K038804N00	12.4	K052381K50	3.4	K171591N00	6.46	KB1335	25.36	KB2355	25.11
K038805N00	12.4	K052381K50	3.7	K2B0502X50	2.19	KB1505	25.34	KB2360	25.25
K038809N00	12.4	K052382K50	3.4	K2B0504X50	2.19	KB1510	25.32	KB2365	25.11
K039118N50	1.6	K052383K50	3.4	K2B0504X50	2.20	KB1515	25.36	KB2390	25.11
K039120N50	1.6	K052390K50	3.4	K2B0504X50	2.21	KB1520	25.37	KB2400	25.5
K039453N50	1.11	K052391K50	3.4	K2B0506X50	2.20	KB1525	25.37	KB2405	25.9
K039454N50	1.11	K054882N00	26.8	K2B0506X50	2.21	KB1535	25.36	KB2410	25.9
K039455N50	1.12	K054884N00	26.8	K2B0514X50	2.20	KB2010	25.4	KB2415	25.9
K038802N00	12.4	K054888N00	26.7	K2B0514X50	2.21	KB2015	25.4	KB2420	25.16
K039530N50	9.7	K055342V01N49	17.12	K2B0516X50	2.21	KB2020	25.4	KB2425	25.5
K039544N50	9.7	K055352V00N49	17.12	K2B0521X50	2.20	KB2025	25.4	KB2440	25.16
K039546N50	9.8	K055369B90	17.12	K2B0521X50	2.21	KB2030	25.4	KB2505	25.20
K039569N50	9.8	K059199N00	9.11	K2B0522X50	2.20	KB2035	25.5	KB2510	25.20
K039571N50	9.8	K066244K50	1.16	K2B0528X50	2.20	KB2040	25.15	KB2515	25.6
K040156N50	9.7	K075169	1.6	K2B0528X50	2.21	KB2045	25.15	KB2540	25.29
K040158N50	9.7	K075170N50	18.6	K2B0543X50	2.20	KB2050	25.15	KB2545	25.29
K040159N50	9.7	K078209N50	4.3	K2B0543X50	2.21	KB2055	25.15	KB2575	25.29
K040432N00	6.44	K079182N50	4.3	K2B1096X50	2.19	KB2060	25.15	KB2580	25.29
K040604N50	1.6	K089063N00	6.44	K2B1097X50	2.19	KB2065	25.15	KB2585	25.26
K040605N50	1.6	K090891N50	4.3	K2B1101/1	2.21	KB2070	25.12	KB2590	25.26
K040606N50	1.6	K093192N50	17.11	K2B1101X50	2.20	KB2075	25.12	KB2595	25.26
K040607N50	1.6	K09587N00	6.44	K2B1222X50	2.20	KB2080	25.12	KB2610	25.12
K040608N50	1.6	K096383	1.12	K2B1222X50	2.21	KB2085	25.10	KB2615	25.12
K040946K50	3.7	K096837K50	1.11	K2C0528X50	2.19	KB2090	25.12	KB2620	25.12

Cross Reference	Page	Cross Reference	Page	Cross Reference	Page	Cross Reference	Page	Cross Reference	Page
KB2625	25.12	KB3205	25.23	KB4320	25.27	KG3107.1.1	16.4	KY1738/2	27.4
KB2630	25.21	KB3210	25.29	KB4460	25.24	KG3401.0.1	16.4	KY1767/11	9.3
KB2635	25.21	KB3255	25.10	KB4465	25.24	KN20615	26.5	KY1767/2	9.3
KB2640	25.21	KB3260	25.10	KB6500	25.19	KN28013.A.1	16.4	KY1767/4	9.2
KB2645	25.21	KB3265	25.13	KB6505	25.19	KN28014.C.1	16.4	KY1767/5	9.3
KB2655	25.11	KB3270	25.13	KB6510	25.19	KN28022D1	16.5	KY1767/8	9.3
KB2700	25.14	KB3295	25.30	KB6515	25.19	KN28027A1	16.5	KY1767/9	9.3
KB2710	25.26	KB3300	25.8	KB6520	25.19	KN30400	23.5	KY1772/2	27.4
KB2715	25.16	KB3315	25.26	KB6525	25.19	KN3406.E66	16.5	KY1810/1	23.3
KB2720	25.16	KB3320	25.26	KB6540	25.19	KN38017.3.5	16.5	KY1916/1	9.3
KB2725	25.6	KB3335	25.13	KB6545	25.19	KN38017.3.6	16.5	KY1916/3	9.3
KB2730	25.6	KB3340	25.13	KB6620	25.14	KNT86230	6.2	KY1916/4	9.3
KB2735	25.26	KB3400	25.13	KB6625	25.13	KW2350/1	1.13	KY1916/5	9.3
KB2740	25.26	KB3425	25.6	KB6630	25.14	KW2350/2	1.13	KY1932/1	15.2
KB2745	25.9	KB3430	25.6	KB6660	25.14	KW2966/1	22.3	KY1952/1	15.2
KB2750	25.16	KB3460	25.8	KB7140	25.18	KW3027	14.16	KY1956/3	15.2
KB2755	25.17	KB3480	25.17	KB914	90.11	KW3027	15.11	KY1994/2	15.2
KB2760	25.6	KB3485	25.23	KG190072.01	16.2	KW3205/1	22.3	KY2106/3	27.4
KB2775	25.28	KB3490	25.23	KG190084.0.2	16.2	KW4455/1	22.3	KY2106/4	27.4
KB2780	25.28	KB3495	25.9	KG19098.1.6	16.2	KW4648/1	22.3	KY2106/5	27.4
KB2785	25.30	KB3520	25.26	KG20001.0.10	16.2	KX1037/1	14.16	KY2106/6	27.4
KB2790	25.30	KB3525	25.27	KG20001.0.8	16.2	KX1037/1	15.11	KY2106/8	27.5
KB2795	25.21	KB3550	25.27	KG20010.0.1	16.2	KX1058/1	22.5	KY2108/1	27.5
KB2800	25.21	KB3555	25.27	KG22019.1.4	16.2	KX1101/2	9.2	KY2184/1	15.2
KB2815	25.21	KB3575	25.10	KG2201911	16.2	KX1125/1	14.17	KY2184/2	15.2
KB2820	25.22	KB3645	25.9	KG22026.0.1	16.2	KX1125/1	15.11	KY2193/1	15.2
KB2905	25.22	KB3655	25.7	KG22027.0.2	16.2	KX1294/1	22.7	KY2193/2	15.2
KB2910	25.22	KB3660	25.7	KG22028.0.2	16.2	KX1294/2	22.7	KY2308/1	23.3
KB2920	25.22	KB3665	25.7	KG23017.1.1	16.3	KX1729/1	21.2	KY807/1	15.2
KB2925	25.22	KB3680	25.10	KG23021.1.3	16.3	KX1729/2	21.2	KY890/1	15.2
KB2930	25.17	KB3685	25.10	KG23027.0.1	16.3	KX1729/3	21.2	KY932/8	12.12
KB2940	25.22	KB3700	25.7	KG23030.0.2	16.3	KX1729/4	21.2	KY952/4	15.2
KB2945	25.22	KB3705	25.7	KG2394.1.12	16.3	KX1729/5	21.2	KY982/6	15.2
KB2955	25.20	KB3710	25.29	KG2395.1.7	16.3	KX175/1	21.2	KY992/1	23.3
KB2975	25.10	KB3755	25.24	KG2397.1.14	16.3	KX175/4	21.2	KZ1087/4	6.13
KB3000	25.6	KB3790	25.7	KG2397.1.19	16.3	KX175/5	21.2	KZ1087/4X50	6.46
KB3005	25.6	KB3795	25.17	KG2397.1.20	16.3	KX2000/1	22.7	KZ1143/2X50	6.47
KB3030	25.28	KB3800	25.18	KG250001.0.2	16.3	KX2006/1	12.3	KZ1192/2	2.17
KB3035	25.28	KB3805	25.29	KG250004.0.2	16.3	KX2045/16	21.2	KZ1228/1	6.13
KB3040	25.22	KB3810	25.30	KG250005.0.1	16.3	KX2045/17	21.2	KZ1228/1X50	6.46
KB3045	25.22	KB3815	25.18	KG250006.0.2	16.3	KX2068/1	1.13	KZ1254	2.18
KB3050	25.23	KB3820	25.18	KG250009.1.1	16.3	KX2068/2	1.13	KZ1257/3X50	6.46
KB3055	25.23	KB3825	25.24	KG25011.0.1	16.3	KX2068/5	1.13	KZ1290/3	2.16
KB3115	25.13	KB3830	25.24	KG2595.1.4	16.4	KX2068/7	1.13	KZ1290/4	2.16
KB3120	25.13	KB3840	25.24	KG2595.1.5	16.3	KX2068/8	1.13	KZ396/2	6.13
KB3125	25.17	KB3845	25.24	KG259615	16.4	KX2073/10	21.2	KZ396/3X50	6.46
KB3130	25.17	KB3890	25.18	KG2597.1.2	16.5	KX2073/13	21.2	KZ433/1	6.13
KB3135	25.29	KB3895	25.18	KG260411	16.4	KX2408/1	9.2	KZ433/1X50	6.46
KB3140	25.29	KB3900	25.10	KG26703.1.1	16.4	KX2552/3	22.8	KZ642/1	6.13
KB3145	25.17	KB3910	25.30	KG28010.0.1	16.4	KY1038/3	15.2	KZ996/1	6.13
KB3150	25.17	KB3915	25.30	KG28011.0.1	16.4	KY1482/1	23.2	KZ996/2	6.13
KB3155	25.17	KB4010	25.18	KG28012.0.1	16.4	KY1482/8	23.2	KZ996/2X50	6.46
KB3165	25.13	KB4015	25.18	KG28014.1.1	16.4	KY1505/1	2.23	LA2103	1.13
KB3170	25.14	KB4200	25.24	KG28019.4.2	16.4	KY1505/2	2.23	LA4128	1.12
KB3195	25.23	KB4215	25.8	KG3106.0.1	16.4	KY1688	2.21	LA4129	1.12
KB3200	25.23	KB4315	25.27	KG3107.0.1	16.4	KY1732/2	27.4	LA4130	1.12

CROSS REFERENCES

Manufacturers Part Numbers are for the purpose of reference only.

Cross Reference	Page	Cross Reference	Page	Cross Reference	Page	Cross Reference	Page	Cross Reference	Page
LA4135	1.12	LA8127	1.4	LA8607	1.6	LK1535	6.2	LK3857	6.7
LA6205	1.3	LA8128	1.4	LA8608	1.6	LK1537	6.2	LK3859	6.7
LA6206	1.3	LA8129	1.4	LA8609	1.6	LK1539	6.2	LK3859	6.43
LA6208	1.3	LA8130	1.5	LA8610	1.6	LK1543	6.2	LK3868	6.4
LA6210	1.3	LA8131	1.5	LA8617	1.6	LK1545	6.2	LK3869	6.46
LA6211	1.3	LA8132	1.5	LA8635	1.6	LK1550	6.2	LK3869	6.42
LA6212	1.3	LA8134	1.5	LA8636	1.6	LK1551	6.2	LK3869	6.43
LA6217	1.3	LA8137	1.5	LA8637	1.6	LK1553	6.2	LK3871	6.7
LA6221	1.3	LA8138	1.5	LA8642	1.6	LK1559	6.2	LK3875	6.7
LA6222	1.3	LA8140	1.5	LA8643	1.6	LK1560	6.2	LK3875	6.41
LA6226	1.3	LA8145	1.5	LA8644	1.6	LK1561	6.2	LK3875	6.43
LA6227	1.3	LA8146	1.5	LA8645	1.6	LK1566	6.2	LK3877	6.5
LA6277	1.3	LA8147	1.5	LA8646	1.6	LK1567	6.2	LK3904	6.4
LA6700	1.3	LA8148	1.5	LA8700	1.6	LK1567	6.43	LK3908	6.4
LA6709	1.3	LA8200	1.5	LA8708	1.6	LK1568	6.2	LK3914	6.4
LA6710	1.3	LA8201	1.5	LA9000	1.6	LK1585	6.2	LK3927	6.4
LA6711	1.3	LA8202	1.5	LA9001	1.6	LK1587	6.2	LK3927	6.44
LA6734	1.3	LA8203	1.5	LA9002	1.6	LK1588	6.2	LK3930	6.6
LA6735	1.3	LA8205	1.5	LA9004	1.6	LK1596	6.2	LK3940	6.6
LA8001	1.4	LA8206	1.5	LA9010	1.6	LK1802	6.3	LK3947	6.44
LA8002	1.4	LA8208	1.5	LA9011	1.6	LK1802	6.43	LK3963	6.4
LA8003	1.4	LA8209	1.5	LA9018	1.6	LK1808	6.3	LK3963	6.5
LA8004	1.4	LA8210	1.5	LA9024	1.6	LK1811	6.3	LK3965	6.6
LA8006	1.4	LA8211	1.5	LA9034	1.6	LK1812	6.3	LK3966	6.6
LA8007	1.4	LA8212	1.5	LA9035	1.6	LK1813	6.3	LK3966	6.42
LA8008	1.4	LA8219	1.5	LH2110004	20.4	LK1813	6.43	LK3966	6.43
LA8011	1.4	LA8220	1.5	LH2110006	20.12	LK1814	6.3	LK3970	6.5
LA8015	1.4	LA8221	1.5	LH2112160	20.7	LK1814	6.43	LK3971	6.5
LA8016	1.4	LA8222	1.5	LK1300	6.2	LK1900	6.3	LK3972	6.5
LA8025	1.4	LA8223	1.5	LK1303	6.2	LK1901	6.3	LK3980	6.44
LA8030	1.4	LA8224	1.5	LK1304	6.2	LK1901	6.43	LK3982	6.6
LA8040	1.4	LA8225	1.5	LK1305	6.2	LK1907	6.3	LK3986	6.6
LA8041	1.4	LA8226	1.5	LK1314	6.2	LK3080	6.4	LK3994	6.7
LA8044	1.4	LA8227	1.5	LK1314	6.43	LK3401	6.7	LK4911	6.17
LA8047	1.4	LA8229	1.5	LK1325	6.2	LK3501	6.6	LK4918	6.14
LA8048	1.4	LA8231	1.5	LK1327	6.2	LK3509	6.6	LK4918	6.41
LA8050	1.4	LA8233	1.5	LK1500	6.2	LK3510	6.6	LK4918	6.43
LA8060	1.4	LA8234	1.5	LK1503	6.2	LK3802	6.4	LK4919	6.14
LA8061	1.4	LA8243	1.5	LK1504	6.2	LK3812	6.4	LK4920	6.14
LA8063	1.4	LA8256	1.5	LK1506	6.2	LK3813	6.5	LK4920	6.43
LA8064	1.4	LA8259	1.5	LK1506	6.43	LK3813	6.46	LK4921	6.14
LA8065	1.4	LA8263	1.5	LK1511	6.2	LK3821	6.6	LK4921	6.41
LA8069	1.4	LA8267	1.5	LK1517	6.2	LK3826	6.4	LK4921	6.43
LA8073	1.4	LA8270	1.5	LK1518	6.2	LK3832	6.4	LK4922	6.14
LA8074	1.4	LA8271	1.5	LK1519	6.2	LK3832	6.5	LK4928	6.17
LA8104	1.4	LA8272	1.5	LK1520	6.2	LK3833	6.6	LK4930	6.19
LA8105	1.4	LA8273	1.5	LK1521	6.2	LK3833	6.39	LK4931	6.17
LA8106	1.4	LA8280	1.5	LK1522	6.2	LK3833	6.43	LK4932	6.17
LA8107	1.4	LA8283	1.5	LK1523	6.2	LK3840	6.7	LK4934	6.17
LA8113	1.4	LA8284	1.5	LK1524	6.2	LK3840	6.43	LK4935	6.16
LA8116	1.4	LA8286	1.5	LK1525	6.2	LK3841	6.7	LK4936	6.16
LA8117	1.4	LA8298	1.5	LK1527	6.2	LK3841	6.43	LK4936	6.44
LA8119	1.5	LA8600	1.6	LK1527	6.43	LK3842	6.6	LK4937	6.16
LA8124	1.4	LA8603	1.6	LK1532	6.2	LK3846	6.7	LK4937	6.44
LA8125	1.4	LA8605	1.6	LK1533	6.2	LK3850	6.39	LK4939	6.17
LA8126	1.4	LA8606	1.6	LK1534	6.2	LK3850	6.43	LK4939	6.44

Cross Reference	Page	Cross Reference	Page	Cross Reference	Page	Cross Reference	Page	Cross Reference	Page
LK4941	6.14	LP4813	6.44	LP4960	6.45	LRG554	3.7	LRG648	3.8
LK4941	6.41	LP4814	6.15	LP4961	6.14	LRG560	3.7	LRG649	3.8
LK4941	6.44	LP4814	6.41	LP4961	6.45	LRG561	3.7	LRG650	3.8
LK4944	6.19	LP4814	6.44	LP4963	6.14	LRG568	3.7	LRG651	3.8
LK4944	6.44	LP4815	6.15	LP4964	6.14	LRG569	3.7	LRG670	3.8
LK4945	6.18	LP4815	6.41	LP4964	6.41	LRG570	3.7	LRG690	3.8
LK4949	6.18	LP4815	6.44	LP4964	6.45	LRG571	3.7	LRG700	3.5
LK4949	6.42	LP4823	6.15	LP4965	6.14	LRG572	3.5	LRG700	3.8
LK4951	6.18	LP4823	6.44	LP4966	6.14	LRG572	3.7	LRG701	3.5
LK4951	6.44	LP4825	6.15	LP4967	6.14	LRG573	3.5	LRG701	3.8
LK4952	6.16	LP4825	6.41	LP4967	6.45	LRG573	3.7	LRG702	3.5
LK4954	6.19	LP4825	6.44	LP4968	6.14	LRG574	3.7	LRG702	3.8
LK4960	6.17	LP4827	6.16	LP4974	6.14	LRG575	3.7	LRG703	3.5
LK4960	6.44	LP4830	6.15	LP4974	6.41	LRG580	3.5	LRG703	3.8
LK4966	6.18	LP4832	6.19	LP4974	6.46	LRG580	3.7	LRG726	3.5
LK4968	6.18	LP4842	6.15	LP4983	6.46	LRG581	3.5	LRG726	3.8
LK4970	6.18	LP4844	6.15	LP4985	6.14	LRG581	3.7	LRG727	3.5
LK4970	6.44	LP4844	6.44	LP4985	6.46	LRG586	3.7	LRG727	3.8
LK4972	6.18	LP4845	6.16	LP4992	6.14	LRG587	3.7	LRG728	3.5
LK4973	6.43	LP4845	6.41	LP4992	6.41	LRG588	3.7	LRG728	3.8
LK4975	6.46	LP4845	6.45	LP4992	6.46	LRG589	3.7	LRG729	3.5
LK8901	6.7	LP4850	6.15	LP700	6.40	LRG592	3.7	LRG729	3.8
LK8907	6.19	LP4850	6.45	LP8701	6.44	LRG593	3.7	LRG730	3.5
LK8907	6.46	LP4851	6.16	LRG500	3.7	LRG596	3.5	LRG730	3.8
LP1527	6.2	LP4851	6.41	LRG501	3.7	LRG597	3.5	LRG731	3.5
LP1537	6.2	LP4851	6.45	LRG506	3.7	LRG597	3.7	LRG731	3.8
LP1567	6.2	LP4852	6.15	LRG507	3.7	LRG598	3.5	LRG736	3.5
LP1806	6.3	LP4855	6.16	LRG508	3.7	LRG598	3.8	LRG736	3.8
LP1828	6.3	LP4855	6.45	LRG509	3.7	LRG599	3.5	LRG737	3.5
LP1828	6.44	LP4857	6.16	LRG510	3.7	LRG599	3.8	LRG737	3.8
LP1959	6.3	LP4857	6.41	LRG511	3.7	LRG600	3.8	LRG740	3.8
LP3813	6.5	LP4857	6.45	LRG520	3.7	LRG601	3.8	LRG741	3.8
LP3830	6.7	LP4861	6.16	LRG521	3.7	LRG602	3.8	LRG764	3.8
LP3830	6.8	LP4861	6.45	LRG522	3.7	LRG603	3.8	LRG765	3.8
LP3832	6.8	LP4863	6.16	LRG523	3.7	LRG606	3.8	LS1500	26.2
LP3833	6.8	LP4863	6.45	LRG524	3.7	LRG607	3.8	LS1500-10	26.2
LP3843	6.8	LP4864	6.16	LRG525	3.7	LRG608	3.8	LS2000	26.2
LP3857	6.8	LP4864	6.45	LRG526	3.7	LRG609	3.8	LS2000-10	26.2
LP3860	6.8	LP4865	6.16	LRG527	3.7	LRG610	3.8	LS2500	26.2
LP3861	6.8	LP4865	6.45	LRG530	3.7	LRG611	3.8	LS2500-10	26.2
LP3927	6.5	LP4871	6.17	LRG531	3.7	LRG612	3.8	LS3907	6.8
LP3927	6.45	LP4871	6.45	LRG536	3.5	LRG613	3.8	LS3907	6.46
LP3940	6.4	LP4930	6.14	LRG536	3.7	LRG620	3.8	LS6000	7.2
LP3940	6.45	LP4934	6.14	LRG537	3.5	LRG621	3.8	M2290010	14.5
LP3970	6.7	LP4934	6.45	LRG537	3.7	LRG622	3.8	M2310000	23.3
LP3970	6.45	LP4938	6.14	LRG542	3.7	LRG623	3.8	M2362000	14.5
LP3974	6.7	LP4940	6.19	LRG543	3.7	LRG624	3.8	MB4419	9.7
LP3977	6.7	LP4942	6.19	LRG544	3.7	LRG625	3.8	MB4434	9.7
LP3980	6.8	LP4943	6.19	LRG545	3.7	LRG626	3.8	MB4477	9.8
LP3986	6.8	LP4944	6.19	LRG546	3.7	LRG627	3.8	MB4510	9.8
LP3993	6.4	LP4944	6.41	LRG547	3.7	LRG630	3.8	MB4512	9.7
LP3997	6.7	LP4949	6.14	LRG548	3.7	LRG631	3.8	MB4523	9.8
LP3997	6.46	LP4955	6.45	LRG549	3.7	LRG634	3.8	MB4611	9.8
LP4812	6.15	LP4957	6.14	LRG550	3.7	LRG635	3.8	MB4613	9.7
LP4812	6.44	LP4957	6.45	LRG551	3.7	LRG638	3.8	MB4629	9.8
LP4813	6.15	LP4960	6.14	LRG553	3.7	LRG639	3.8	MB4630	9.8

CROSS REFERENCES

Manufacturers Part Numbers are for the purpose of reference only.

Cross Reference	Page	Cross Reference	Page	Cross Reference	Page	Cross Reference	Page	Cross Reference	Page
MB4631	9.8	MJS2424ET551	2.20	RE2225	23.7	SV1334	14.9	SV3200	26.7
MB4643	9.8	MJS2430ET549	2.20	RE2228	23.7	SV1343	14.10	SV3240	26.7
MB4644	9.8	MJS3028ET200	2.20	RE3312	23.7	SV1344	14.10	SV3241	26.7
MB4648	9.8	MJS3028ET549	2.20	RP2B	23.7	SV1345	14.10	SV3273	26.8
MB4649	9.8	MJS3028ET551	2.20	S1490	14.12	SV1350	14.10	SV3293	26.8
MB4653	9.8	MJS3030ET152	2.20	S2CP10.055A	5.17	SV1351	14.10	SV3302	10.3
MB4658	9.8	MJS3030ET153	2.20	S4457-01330	18.2	SV1352	14.10	SV33115	26.7
MB4673	9.8	MJS3030ET549	2.20	SBT21137	25.37	SV1361	14.10	SV3336	10.3
MB4674	9.8	MKG190110.4.2	16.5	SC1006	90.12	SV1362	14.10	SV3360	10.3
MB4679	9.8	MKG20003.4.2	16.5	SC1C	24.3	SV1369	14.10	SV3367	10.3
MB4683	9.9	MKG23852.4.3	16.5	SC2CK	24.3	SV1370	14.10	SV3368	10.3
MB4690	9.9	MP13AX	15.5	SC4A	24.3	SV1371	14.10	SV3371	10.3
MB4694	9.9	MP51AX	15.5	SEB00014	24.3	SV1376	14.10	SV3801	26.8
MB4710	9.9	MP51AY	15.5	SEB00256	14.17	SV1377	14.10	SZ1114	24.5
MB4803	9.9	MP51CY	15.5	SEB00256	15.11	SV1378	14.10	SZ1117	24.3
MB4805	9.9	MP70A	15.5	SEB00310	27.3	SV1380	14.10	SZ1159	24.3
MB4806	9.9	MS10A	15.5	SEB00662	26.6	SV1381	14.10	SZ1211	24.3
MB4815	9.9	MVAA-220-3A1-NC	8.4	SEB01183	21.3	SV1385	14.11	V2080165	21.2
MB4820	9.9	MVAA-220-3A1-NO	8.4	SEB01258	21.3	SV1395	14.11	VG3156	5.2
MB4821	9.9	MXC4836	3.5	SK26541	2.26	SV1399	14.11	VG3200	5.2
MB4825	9.9	MXC4837	3.5	SK2914/1	1.10	SV1403	14.11	VG3204	5.2
MB4837	9.9	NR1PH75	2.18	SP8540	25.40	SV1404	14.11	VG3208	5.2
MB4847	9.9	OM501/502	6.38	SPGB28814	7.2	SV1410	14.11	VG3213	5.2
MB4849	9.9	PCGA1046	6.32	ST1033	25.40	SV1411	14.11	VG3215	5.2
MB4852	9.9	PCGA1059	6.32	ST1035	25.40	SV1412	14.11	VG3218	5.2
MB9000	9.9	PCGA1072	6.32	ST1036	25.40	SV1417	14.11	VG3224	5.2
MCK1138	3.9	PNP300340000	14.5	ST1037	25.40	SV1421	14.11	VG3227	5.2
MCK1252	3.9	PNP300360000	14.5	ST4011	25.40	SV1422	14.11	VG3228	5.2
MCK1300	3.9	PNP306250000	14.5	ST4013	25.40	SV1425	14.11	VG3229	5.2
MCK1301	3.9	PNP308040100	14.5	ST4014	25.40	SV1426	14.11	VG3234	5.2
MCK1311	3.37	PNP308990200	14.5	SV1200	14.8	SV1430	14.11	VG3261	5.2
MCK1319	3.9	PNP309100100	14.5	SV1202	14.8	SV1440	14.11	VG3262	5.2
MCK1331	3.5	PNP3103202YY	14.5	SV1230	14.8	SV1441	14.11	VG3264	5.3
MCK1331	3.9	PNP311600200	14.5	SV1260	14.8	SV1445	14.12	VG3267	5.2
MCK1332	3.5	PNP311600201	14.6	SV1261	14.8	SV1447	14.12	VG3268	5.2
MCK1332	3.9	PNP311600203	14.6	SV1269	14.8	SV1460	14.12	VG3269	5.2
MCK1345	3.5	PNP311600204	14.6	SV1280	14.8	SV1461	14.12	VG3276	5.2
MCK1345	3.9	R950364101	17.2	SV1281	14.8	SV1463	14.12	VG3284	5.2
MCK1346	3.5	R950364102	17.2	SV1287	14.8	SV1465	14.12	VG3286	5.2
MCK1346	3.9	R950364103	17.2	SV1288	14.8	SV1466	14.12	VG3288	5.3
MCK1376	3.9	RE1100	23.6	SV1294	14.8	SV1481	14.12	VG3289	5.3
MCK1377	3.9	RE1102	23.6	SV1295	14.9	SV1482	14.12	VG3304	5.3
MCK1384	3.9	RE1104	23.6	SV1296	14.9	SV1485	14.12	VG3361	5.3
MCK1385	3.9	RE1105	23.6	SV1298	14.9	SV1490	14.2	VG3364	5.3
MCK1386	3.9	RE1108	23.7	SV1299	14.9	SV1491	14.2	VPS40C	18.6
MJB1724ET053	2.20	RE1115	23.7	SV1303	14.9	SV1493	14.2	VPS41A	18.6
MJB1724ET749	2.20	RE1119	23.7	SV1304	14.9	SV1494	14.12	VPS45A	18.6
MJB2024ET702	2.20	RE1121	23.7	SV1307	14.9	SV1496	14.2	VPS45HY	18.6
MJB2030ET702	2.20	RE1126	23.7	SV1310	14.9	SV3111	26.7	VPS48A	18.7
MJB2030ET703	2.20	RE1132	23.7	SV1318	14.9	SV3113	26.7	VPS48AI	18.7
MJB2030ET712	2.20	RE1137	23.7	SV1321	14.9	SV3118	26.7	VPS48H	18.7
MJB2124ET702	2.20	RE1138	23.7	SV1323	14.9	SV3130	26.7	VPS48HI	18.7
MJB2430ET054	2.20	RE1141	23.7	SV1325	14.9	SV3133	26.7	VPS48MIY	18.7
MJS1216AT051	2.20	RE1201	23.7	SV1328	14.9	SV3157	26.7	VPS48NIY	18.7
MJS2024ET549	2.20	RE2221	23.7	SV1329	14.9	SV3158	26.7	VTN-1	26.2
MJS2424ET549	2.20	RE2224	23.7	SV1330	14.9	SV3162	26.7	VTN-1/10	26.2

Cross Reference	Page	Cross Reference	Page
VTP-1	26.2	ZB4737	4.3
WAK7373Y39	20.3	ZB4738	4.3
WKV2I30092	7.3	ZB4739	4.3
WKV2I30093	7.3	ZB4740	4.3
WM543	9.19	ZB4741	4.3
WM90	9.19	ZB4742	4.3
X3064102	7.3	ZB4803	4.3
X3066502	7.3	ZB4809	4.3
X3067702	7.3		
X8880843	8.3		
ZB3130	14.16		
ZB3130	15.11		
ZB4400	4.2		
ZB4402	4.2		
ZB4414	4.2		
ZB4424	4.2		
ZB4427	4.2		
ZB4505	4.2		
ZB4506	4.2		
ZB4511	4.2		
ZB4512	4.2		
ZB4513	4.2		
ZB4528	4.2		
ZB4534	4.2		
ZB4535	4.2		
ZB4544	4.2		
ZB4564	4.2		
ZB4578	4.2		
ZB4579	4.2		
ZB4580	4.2		
ZB4583	4.2		
ZB4586	4.2		
ZB4587	4.2		
ZB4592	4.2		
ZB4593	4.2		
ZB4596	4.2		
ZB4597	4.2		
ZB4600	4.2		
ZB4601	4.2		
ZB4602	4.2		
ZB4603	4.2		
ZB4631	4.2		
ZB4633	4.2		
ZB4636	4.2		
ZB4700	4.2		
ZB4701	4.2		
ZB4706	4.2		
ZB4707	4.2		
ZB4708	4.3		
ZB4730	4.3		
ZB4731	4.3		
ZB4732	4.3		
ZB4733	4.3		
ZB4734	4.3		
ZB4735	4.3		
ZB4736	4.3		

WARRANTY POLICY TERMS AND CONDITIONS

This warranty Policy applies to all products supplied by EBS. Warranty claims will be tested as per the EBS procedures (a copy of these procedures can be supplied upon request).

EBS will replace or credit the acquisition cost of any unit that is determined by EBS to be defective.

The legitimacy of any warranty claim will be considered in the understanding that:

- The unit is returned within the timescales laid out in the EBS terms and conditions of sale.
- The unit is accompanied by a fully completed warranty claim form.
- The unit has been installed and maintained by qualified personnel in accordance with the vehicle manufacturer's instructions that may be unique to any given unit.

The warranty policy will not apply if:

In the judgement of EBS, the unit(s) or part(s) have been subject to damage by accident, fire, misuse, negligence or attempted repair by a third party.

Product identification labels, plates or inscriptions have been altered, removed, obliterated or damaged in any way.

Corrosion and/ or the ingestion of foreign material, which is considered detrimental to the proper function of any air, mechanical or hydraulic part, unless it can be determined to be assignable to a defect in material or manufacturing process.

This warranty policy does not cover:

- Claims where an air or hydraulic part shows ingestion of foreign material into the part. This includes liquids, solid materials and alcohol-based products.
- Claims for Air Dryers or Air Processing Units where the desiccant cartridge is found to be contaminated with oil, water or any other foreign matter.
- Claims for products where failure is caused by lack of servicing or maintenance of the product.
- Products that are not installed correctly or are incorrect for application.
- Claims resulting from the improper fitting of mating products not supplied by EBS
- Claims for electronic parts that are not accompanied by a full and complete diagnostic report.
- Claims which are not accompanied by a fully completed EBS Warranty Claim Form.

The liability under this warranty policy shall not exceed the purchase price paid. EBS is not responsible for "down time" expenses, cargo damage or any other business costs or losses resulting from failure or use of parts supplied by EBS

Should the customer request a report from any manufacturer other than EBS this must be clearly stated on the Warranty Claim Form. The customer must accept any subsequent charge levied by that manufacturer.

Any claim that has already been investigated by an EBS warranty representative cannot be subsequently submitted for a non-EBS branded manufacturer's report.

THIS WARRANTY IS IN LIEU OF ALL OTHER WARRANTIES, EXPRESSED OR IMPLIED, INCLUDING ANY IMPLIED WARRANTY OF MERCHANTABILITY OR FITNESS FOR A PARTICULAR PURPOSE AND ALL OTHER OBLIGATIONS OR LIABILITIES, INCLUDING LIABILITY FOR INCIDENTAL, SPECIAL, CONSEQUENTIAL DAMAGES OR LABOUR.

Your statutory rights are unaffected by this policy.

DISCLAIMER

- All manufacturers references and images contained within this catalogue are for the purpose of reference only and do not imply or insinuate that the part is of original manufacture.
- The EBS logo and strapline "Brake Evolution" and packaging designs are registered trademarks Of European Braking Systems Ltd, EBS retains the power of disposal, such as copying, reproducing and transferring or the use of without prior written authorisation from European Braking Systems. All those responsible for reproducing the EBS Logo in print, broadcast or electronic form must do so in accordance with the EBS guidelines and brand standards set out in the EBS Brand Guidelines and EBS Packaging Guidelines available on request. Any incorrect reproduction or unauthorised use of the EBS registered trademark / logos will be pursued vigorously.
- Whilst EBS does supply genuine products the purpose of this catalogue is to provide a guide to the customer enabling them to find the correct part required for their application. EBS cannot accept any liability nor offer any guarantee regarding data accuracy,
- Whilst every attempt has been made to ensure the accuracy of the information contained within, there may be mistakes and it is advised that customers telephone our sales department prior to ordering to confirm the suitability of the parts ordered.
- EBS will not and can not accept responsibility for incorrect orders if the customer fails to obtain verification prior to ordering.
- Subject to alteration without notice.
- This document, in part or in whole, may not be copied, transmitted or reproduced in any form without prior written authorisation from European Braking Systems.



CREDITS:

Technical input:

- Adil El Kassimi
- Nigel Brockie
- Robert Statham
- Colin Openshaw

Edition and artwork:

- Nuria Montero



EBS | AFTERMARKET GROUP



European Braking Systems Ltd

Units 1-4 Clarence Avenue,
Westpoint Enterprise Park,
Trafford Park, Manchester
M17 1QS
United Kingdom

1703, Building No. 4,
Baolong Square
Zhonglou District
Changzhou City
Jiangsu,
China

Assured Performance Ireland Ltd

Unit 12 & 13,
Ballymount Court
Business Centre,
Ballymount Road, Walkinstown,
Dublin 12, D12 X318,
Ireland

Air Brake Company Holland B.V

Hogelandseweg 89
6545 AB Nijmegen,
Netherlands

Drakefield Ltd

Unit 60 Horndon Industrial Park
Station Road, West Horndon
Essex, CM13 3XL
United Kingdom

European Braking Systems SRL (EBS Romania)

Goranu nr 56A,
Râmnicu Valcea,
judet Valcea, 240440,
Romania

EAGAL Inc. United States

1675 South State Street,
Suite B, Dover, Delaware,
DE 19901





PRODUCT CATALOGUE EDITION 5

